

Fuses for Semiconductor Protection

European Standard

Sizes 000 and 00

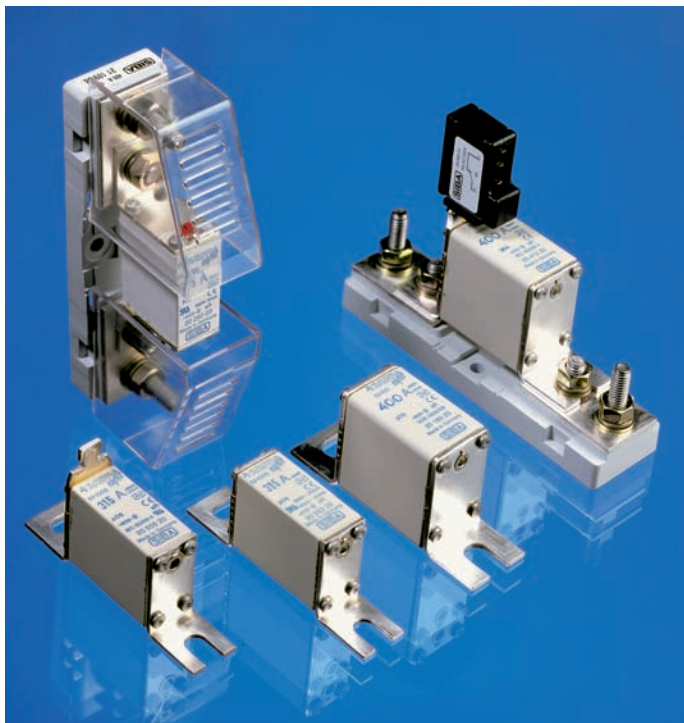

Class: aR

Voltage ratings: AC 660 V – AC 1000 V

Current ratings: 16 A to 400 A

Approvals: 

Standards: DIN 43653
IEC 60269-1 and -4
DIN VDE 0636-40
UL 248-13

Features / Benefits

- ▶ Extremely high interrupting rating 100 kA – 300 kA
- ▶ Voltage ratings AC 660 V – AC 1000 V
- ▶ Protection of Power Semiconductors according to IEC 60269-1 and -4
- ▶ Complies with DIN 43653 – sizes 000 and 00 with or without Topindicator and trip microswitch
- ▶ aR class 16 A–400 A according to IEC 60269-4 and DIN VDE 0636-40
- ▶ Fuse-bases and accessories are available



Fuses for Semiconductor Protection

European Standard

Sizes 000 and 00

Selection Guide

Size	Rated Voltage [AC]	Fixing Center	Indicator *	Part No. Type	Selector Guide [Page]	Techn. Data [Page]
000	660 V	3,15" (80 mm)	with top indicator	20 282 04	URB 3	URB 10
000	660 V	3.15" (80 mm)	without top indicator	20 282 41	URB 3	URB 10
000	660 V	3.15" (80 mm)	with micro switch fitting	20 558 04	URB 4	URB 10
000	690/700 V	3.15" (80 mm)	with top indicator	20 282 20	URB 3	URB 11
000	690/700 V	3.15" (80 mm)	without top indicator	20 282 21	URB 3	URB 11
000	690/700 V	3.15" (80 mm)	with micro switch fitting	20 558 20	URB 4	URB 11
00	660 V	3.15" (80 mm)	with top indicator	20 189 04	URB 5	URB 12
00	660 V	3.15" (80 mm)	without top indicator	20 189 41	URB 5	URB 12
00	660 V	3.15" (80 mm)	with micro switch fitting	20 412 04	URB 6	URB 12
00	690/700 V	3.15" (80 mm)	with top indicator	20 189 20	URB 5	URB 13
00	690/700 V	3.15" (80 mm)	without top indicator	20 189 21	URB 5	URB 13
00	690/700 V	3.15" (80 mm)	with micro switch fitting	20 412 20	URB 7	URB 13
00	1000 V	3.15" (80 mm)	with top indicator	20 560 20	URB 8	URB 14
00	1000 V	3.15" (80 mm)	without top indicator	20 560 21	URB 8	URB 14
00	1000 V	3.15" (80 mm)	with micro switch fitting	20 562 20	URB 9	URB 14
Fuse-Base	1000 V			21 189 01		URB 15
Fuse-Base	1000 V			21 189 08		URB 15
Fuse-Base	1000 V			21 189 11		URB 16
Micro switch	250 V			28 002 01		URB 17
Micro switch	250 V			28 002 02		URB 17

* Minimum operating voltage for top indicator 6.5V



Fuses for Semiconductor Protection
European Standard

Sizes 000 and 00

Size **000** Rated Voltage **AC 660 V** Standard **DIN 43653**

Rated Current [A]	Part No. with Top Indicator	Part No. without Top Indicator	UL Rec.	Weight [kg/1]	Pack
16	20 282 04.16	20 282 41.16		0.17	6
20	20 282 04.20	20 282 41.20		0.17	6
25	20 282 04.25	20 282 41.25		0.17	6
32	20 282 04.32	20 282 41.32		0.17	6
35	20 282 04.35	20 282 41.35		0.17	6
40	20 282 04.40	20 282 41.40		0.17	6
50	20 282 04.50	20 282 41.50		0.17	6
63	20 282 04.63	20 282 41.63		0.17	6
80	20 282 04.80	20 282 41.80		0.17	6
100	20 282 04.100	20 282 41.100		0.17	6
125	20 282 04.125	20 282 41.125		0.17	6
160	20 282 04.160	20 282 41.160		0.17	6

Size **000** Rated Voltage **AC 690/700 V** Standard **DIN 43653**

Rated current [A]	Part No. with Top Indicator	Part No. without Top Indicator	UL Rec.	Weight [kg/1]	Pack
32	20 282 20.32	20 282 21.32	✓	0.17	6
35	20 282 20.35	20 282 21.35	✓	0.17	6
40	20 282 20.40	20 282 21.40	✓	0.17	6
50	20 282 20.50	20 282 21.50	✓	0.17	6
63	20 282 20.63	20 282 21.63	✓	0.17	6
80	20 282 20.80	20 282 21.80	✓	0.17	6
100	20 282 20.100	20 282 21.100	✓	0.17	6
125	20 282 20.125	20 282 21.125	✓	0.17	6
160	20 282 20.160	20 282 21.160	✓	0.17	6
200	20 282 20.200	20 282 21.200	✓	0.17	6
250	20 282 20.250	20 282 21.250	✓	0.17	6
315	20 282 20.315	20 282 21.315	✓	0.17	6

Available in DC 700 V see URDC section.

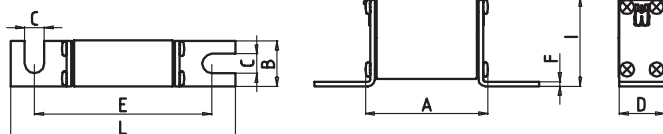

- A** 2.17" (55 mm)
- B** 0.80" (20 mm)
- C** 0.33" (8.5 mm)
- D** 0.80" (20.4 mm)
- E** 3.07" (78 mm)
- F** 0.08" (2 mm)
- I** 1.54" (39 mm)
- L_(max)** 3.94" (100 mm)

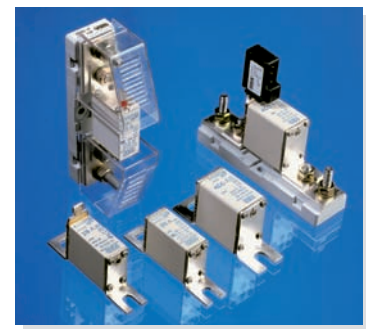

Fuses for Semiconductor Protection

European Standard

Sizes 000 and 00

Size **000** Rated Voltage **AC 660 V** Standard **DIN 43653**

Rated Current [A]	Part No. Top Indicator and Fitting for Micro Switch	UL Rec.	Weight [kg/1]	Pack
16	20 558 04.16		0.17	6
20	20 558 04.20		0.17	6
25	20 558 04.25		0.17	6
32	20 558 04.32		0.17	6
35	20 558 04.35		0.17	6
40	20 558 04.40		0.17	6
50	20 558 04.50		0.17	6
63	20 558 04.63		0.17	6
80	20 558 04.80		0.17	6
100	20 558 04.100		0.17	6
125	20 558 04.125		0.17	6
160	20 558 04.160		0.17	6

Size **000** Rated Voltage **AC 690/700 V** Standard **DIN 43653**

Rated Current [A]	Part No. Top Indicator and Fitting for Micro Switch	UL Rec.	Weight [kg/1]	Pack
32	20 558 20.32		0.18	6
35	20 558 20.35	✓	0.18	6
40	20 558 20.40	✓	0.18	6
50	20 558 20.50	✓	0.18	6
63	20 558 20.63	✓	0.18	6
80	20 558 20.80	✓	0.18	6
100	20 558 20.100	✓	0.18	6
125	20 558 20.125	✓	0.18	6
160	20 558 20.160	✓	0.18	6
180	20 558 20.180	✓	0.18	6
200	20 558 20.200	✓	0.18	6
250	20 558 20.250	✓	0.18	6
315	20 558 20.315	✓	0.18	6

- A** 2.17" (55 mm)
- B** 0.80" (20 mm)
- C** 0.33" (8,5 mm)
- D** 0.80" (20,4 mm)
- E** 3.07" (78 mm)
- F** 0.08" (2 mm)
- G** 2.10" (53 mm)
- H** 2.76" (70 mm)
- I** 1.54" (39 mm)
- L_(max)** 3.94" (100 mm)

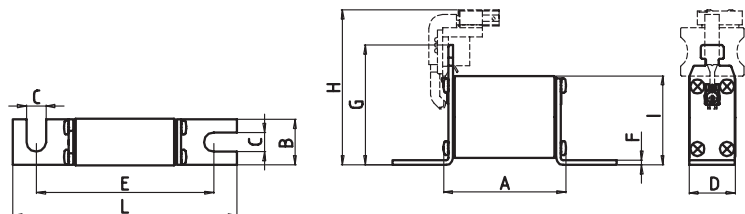

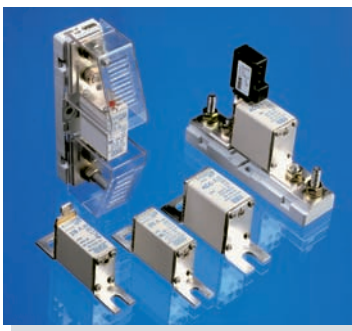

Fuses for Semiconductor Protection
European Standard

Sizes 000 and 00

Size **00** Rated Voltage **AC 660 V** Standard **DIN 43653**

Rated Current [A]	Part No. with Top Indicator	Part No. without Top Indicator	UL Rec.	Weight [kg/1]	Pack
16	20 189 04.16	20 189 41.16		0.19	3
20	20 189 04.20	20 189 41.20		0.19	3
25	20 189 04.25	20 189 41.25		0.19	3
32	20 189 04.32	20 189 41.32		0.19	3
35	20 189 04.35	20 189 41.35		0.19	3
40	20 189 04.40	20 189 41.40		0.19	3
50	20 189 04.50	20 189 41.50		0.19	3
63	20 189 04.63	20 189 41.63		0.19	3
80	20 189 04.80	20 189 41.80		0.19	3
100	20 189 04.100	20 189 41.100		0.19	3
125	20 189 04.125	20 189 41.125		0.19	3
160	20 189 04.160	20 189 41.160		0.19	3
200	20 189 04.200	20 189 41.200		0.19	3
250	20 189 04.250	20 189 41.250		0.19	3

Size **00** Rated Voltage **AC 690/700 V** Standard **DIN 43653**

Rated Current [A]	Part No. with Top Indicator	Part No. without Top Indicator	UL Rec.	Weight [kg/1]	Pack
32	20 189 20.32	20 189 21.32	✓	0.21	3
35	20 189 20.35	20 189 21.35	✓	0.21	3
40	20 189 20.40	20 189 21.40	✓	0.21	3
50	20 189 20.50	20 189 21.50	✓	0.21	3
63	20 189 20.63	20 189 21.63	✓	0.21	3
80	20 189 20.80	20 189 21.80	✓	0.21	3
100	20 189 20.100	20 189 21.100	✓	0.21	3
125	20 189 20.125	20 189 21.125	✓	0.21	3
160	20 189 20.160	20 189 21.160	✓	0.21	3
200	20 189 20.200	20 189 21.200	✓	0.21	3
250	20 189 20.250	20 189 21.250	✓	0.21	3
315	20 189 20.315	20 189 21.315	✓	0.21	3
350	20 189 20.350	20 189 21.350	✓	0.21	3
400	20 189 20.400	20 189 21.400	✓	0.21	3

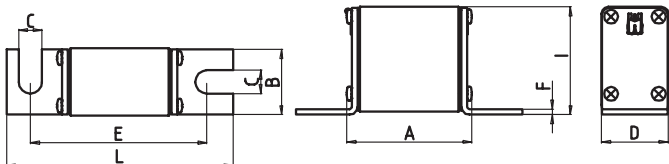

A	2.17" (55 mm)	F	0.10" (2,5 mm)
B	1.13" (28,8 mm)	I	1.85" (47 mm)
C	0.40" (10,3 mm)	L_(max)	4.13" (105 mm)
D	1.16" (29,5 mm)		
E	3.07" (78 mm)		



Fuses for Semiconductor Protection

European Standard

Sizes 000 and 00

Size
00

Rated Voltage
AC 660 V

Standard
DIN 43653

Rated Current [A]	Part No. Top Indicator and Fitting for Micro Switch	UL Rec.	Weight [kg/1]	Pack
16	20 412 04.16		0.21	3
20	20 412 04.20		0.21	3
25	20 412 04.25		0.21	3
32	20 412 04.32		0.21	3
35	20 412 04.35		0.21	3
40	20 412 04.40		0.21	3
50	20 412 04.50		0.21	3
63	20 412 04.63		0.21	3
80	20 412 04.80		0.21	3
100	20 412 04.100		0.21	3
125	20 412 04.125		0.21	3
160	20 412 04.160		0.21	3
200	20 412 04.200		0.21	3
250	20 412 04.250		0.21	3

A 2.17" (55 mm)	F 0.10" (2.5 mm)
B 1.13" (28.8 mm)	G 2.48" (63 mm)
C 0.40" (10.3 mm)	H 3.15" (80 mm)
D 1.16" (29.5 mm)	I 1.54" (39 mm)
E 3.07" (78 mm)	L_(max) 4.13" (105 mm)

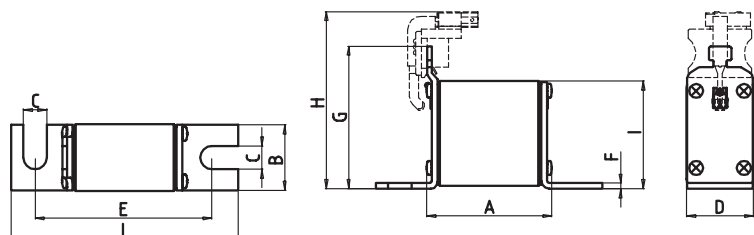



Fuses for Semiconductor Protection
European Standard

Sizes 000 and 00

Size 00	Rated Voltage AC 690/700 V	Standard DIN 43653
--------------------------	---	-------------------------------------

Rated Current [A]	Part No. Top Indicator and Fitting for Micro Switch	UL Rec.	Weight [kg/1]	Pack
32	20 412 20.32		0.21	3
35	20 412 20.35		0.21	3
40	20 412 20.40		0.21	3
50	20 412 20.50		0.21	3
63	20 412 20.63		0.21	3
80	20 412 20.80		0.21	3
100	20 412 20.100		0.21	3
125	20 412 20.125		0.21	3
160	20 412 20.160	✓	0.21	3
200	20 412 20.200	✓	0.21	3
250	20 412 20.250	✓	0.21	3
315	20 412 20.315	✓	0.21	3
350	20 412 20.350	✓	0.21	3
400	20 412 20.400		0.21	3

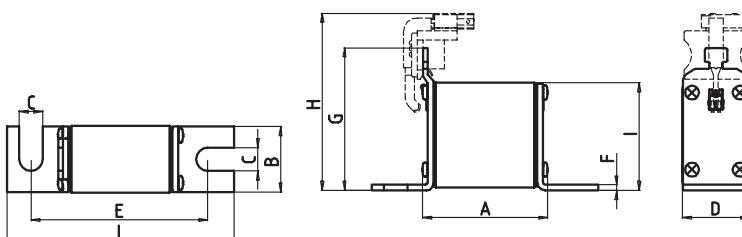

A 2.17" (55 mm)	F 0.10" (2.5 mm)
B 1.13" (28.8 mm)	G 2.48" (63 mm)
C 0.40" (10.3 mm)	H 3.15" (80 mm)
D 1.16" (29.5 mm)	I 1.85" (47 mm)
E 3.07" (78 mm)	L_(max) 4.13" (105 mm)



Fuses for Semiconductor Protection

European Standard

Sizes 000 and 00

Size
00

Rated Voltage
AC 1000 V

Standard
DIN 43653

Rated Current [A]	Part No. with Top Indicator	Part No. without Top Indicator	UL Rec.	Weight [kg/1]	Pack
32	20 560 20.32	20 560 21.32		0.21	3
40	20 560 20.40	20 560 21.40		0.21	3
50	20 560 20.50	20 560 21.50		0.21	3
63	20 560 20.63	20 560 21.63		0.21	3
80	20 560 20.80	20 560 21.80		0.21	3
100	20 560 20.100	20 560 21.100		0.21	3
125	20 560 20.125	20 560 21.125		0.21	3
160	20 560 20.160	20 560 21.160		0.21	3
200	20 560 20.200	20 560 21.200		0.21	3
250	20 560 20.250	20 560 21.250		0.21	3
315*	20 560 20.315	20 560 21.315		0.21	3

* 900 Vac

A	2.17" (55 mm)	F	0.10" (2,5 mm)
B	1.13" (28,8 mm)	I	1.85" (47 mm)
C	0.40" (10,3 mm)	L_(max)	4.13" (105 mm)
D	1.16" (29,5 mm)		
E	3.07" (78 mm)		

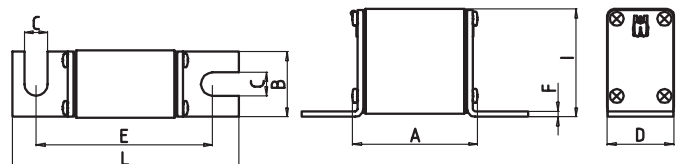



Fuses for Semiconductor Protection
European Standard

Sizes 000 and 00

Size 00	Rated Voltage AC 1000 V	Standard DIN 43653
--------------------------	--	-------------------------------------

Rated Current [A]	Part No. Top Indicator and Fitting for Micro Switch	UL Rec.	Weight [kg/1]	Pack
32	20 562 20.32		0.21	3
40	20 562 20.40		0.21	3
50	20 562 20.50		0.21	3
63	20 562 20.63		0.21	3
80	20 562 20.80		0.21	3
100	20 562 20.100		0.21	3
125	20 562 20.125		0.21	3
160	20 562 20.160		0.21	3
200	20 562 20.200		0.21	3
250	20 562 20.250		0.21	3
315*	20 562 20.315		0.21	3

* 900 Vac

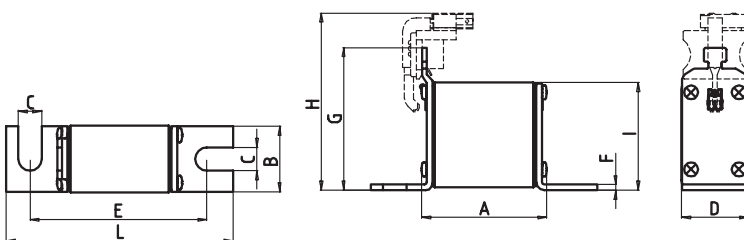

A	2.17" (55 mm)	F	0.10" (2.5 mm)
B	1.13" (28.8 mm)	G	2.48" (63 mm)
C	0.40" (10.3 mm)	H	3.15" (80 mm)
D	1.16" (29.5 mm)	I	1.85" (47 mm)
E	3.07" (78 mm)	L_(max)	4.13" (105 mm)

Size
000

Rated Voltage
AC 660 V

Operating Class
aR

Rated Breaking Capacity
100 kA

Rated Current [A]	Part No. with Top Indicator	Part No. without Top Indicator	Part No. Fitting for Micro Switch	Power Loss [W]	Pre-arcing I ² t-value [A ² s]	Total I ² t-value @ 660 V [A ² s]
16	20 282 04.16	20 282 41.16	20 558 04.16	5	10	70
20	20 282 04.20	20 282 41.20	20 558 04.20	6	17	120
25	20 282 04.25	20 282 41.25	20 558 04.25	7	29	200
32	20 282 04.32	20 282 41.32	20 558 04.32	9	66	450
35	20 282 04.35	20 282 41.35	20 558 04.35	9	81	550
40	20 282 04.40	20 282 41.40	20 558 04.40	10	103	700
50	20 282 04.50	20 282 41.50	20 558 04.50	11	184	1 300
63	20 282 04.63	20 282 41.63	20 558 04.63	13	330	2 300
80	20 282 04.80	20 282 41.80	20 558 04.80	18	512	3 500
100	20 282 04.100	20 282 41.100	20 558 04.100	22	930	6 400
125	20 282 04.125	20 282 41.125	20 558 04.125	24	1 650	11 200
160	20 282 04.160	20 282 41.160	20 558 04.160	28	4 250	29 000

Cut-Off characteristics

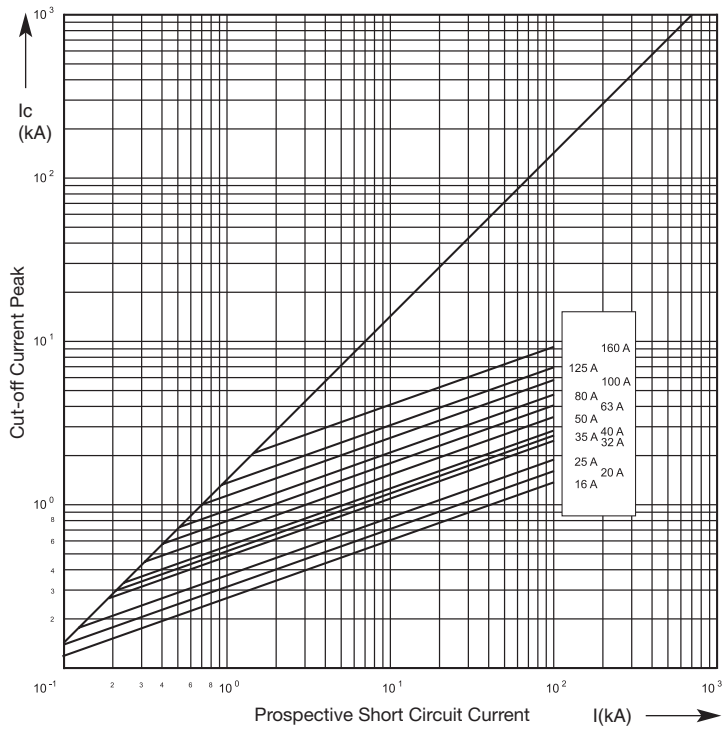

Time-Current Characteristics

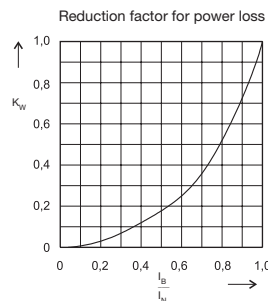
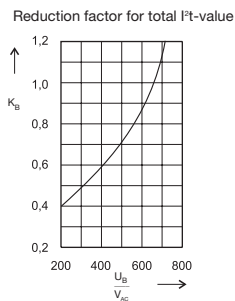
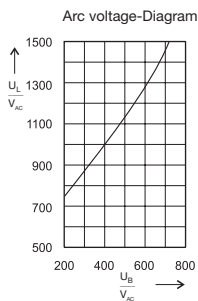
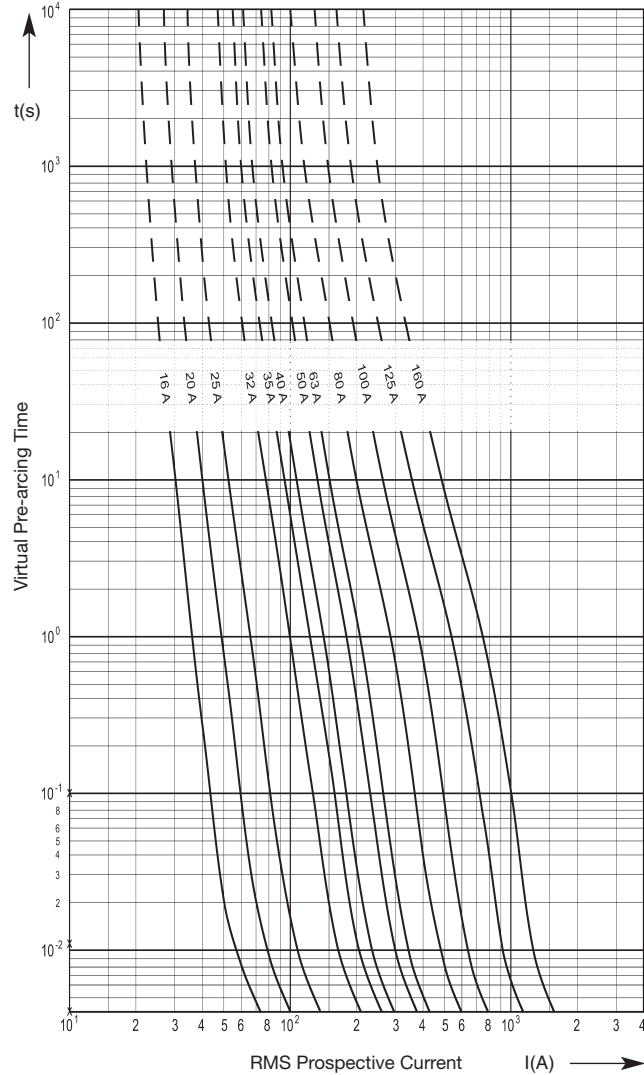

Size 000	Rated Voltage AC 690/700 V	Operating Class aR	Rated Breaking Capacity 600 V / 300 kA · 700 V / 200 kA
--------------------	--------------------------------------	------------------------------	---

Rated Current [A]	Part No. with Top Indicator	Part No. without Top Indicator	Part No. Fitting for Micro Switch	Power Loss [W]	Pre-arcing I ² t-value [A ² s]	Total I ² t-value @ 660 V [A ² s]
32	20 282 20.32	20 282 21.32	20 558 20.32	8	52	290
35	20 282 20.35	20 282 21.35	20 558 20.35	9	66	360
40	20 282 20.40	20 282 21.40	20 558 20.40	10	90	500
50	20 282 20.50	20 282 21.50	20 558 20.50	12	140	770
63	20 282 20.63	20 282 21.63	20 558 20.63	14	250	1 400
80	20 282 20.80	20 282 21.80	20 558 20.80	18	470	2 600
100	20 282 20.100	20 282 21.100	20 558 20.100	22	730	4 000
125	20 282 20.125	20 282 21.125	20 558 20.125	26	1 300	7 200
160	20 282 20.160	20 282 21.160	20 558 20.160	32	2 800	15 400
180	20 282 20.180	20 282 21.180	20 558 20.180	35	3 700	20 400
200	20 282 20.200	20 282 21.200	20 558 20.200	39	4 500	25 000
250	20 282 20.250	20 282 21.250	20 558 20.250	47	8 000	44 000
315	20 282 20.315	20 282 21.315	20 558 20.315	58	14 000	77 000

Cut-Off characteristics

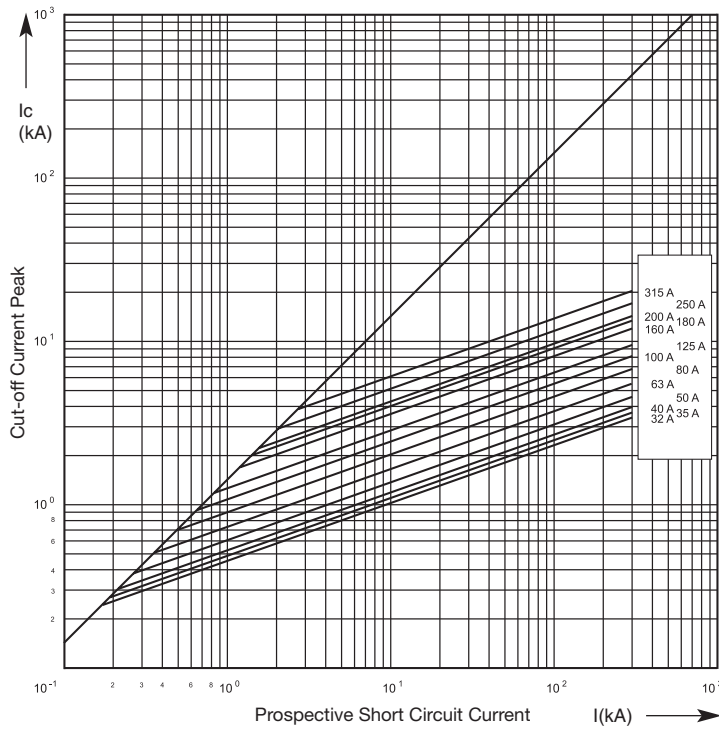

Time-Current Characteristics

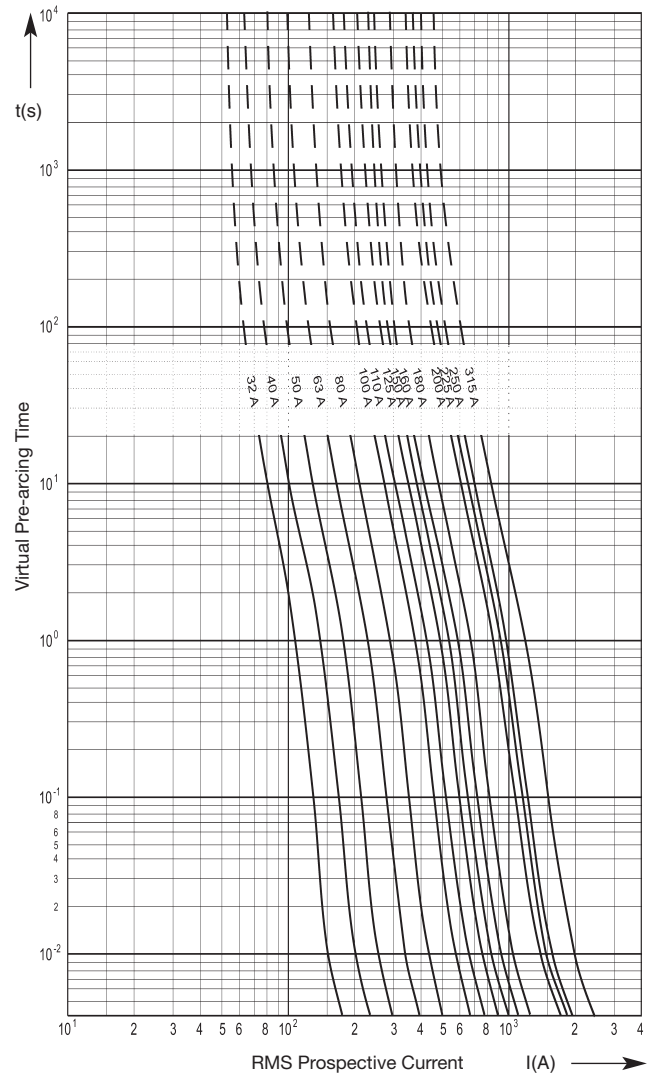

Arc voltage-Diagram

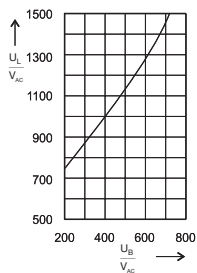

Reduction factor for total I²t-value

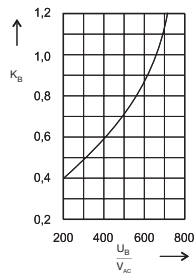

Reduction factor for power loss

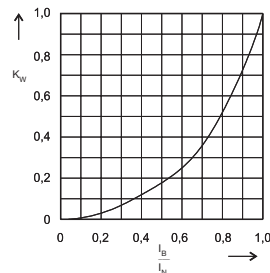

Size
00

Rated Voltage
AC 660 V

Operating Class
aR

Rated Breaking Capacity
100 kA

Rated Current [A]	Part No. with Top Indicator	Part No. without Top Indicator	Part No. Fitting for Micro Switch	Power Loss [W]	Pre-arcing I ² t-value [A ² s]	Total I ² t-value @ 660 V [A ² s]
16	20 189 04.16	20 189 41.16	20 412 04.16	4.6	10	70
20	20 189 04.20	20 189 41.20	20 412 04.20	5.5	17	120
25	20 189 04.25	20 189 41.25	20 412 04.25	6.7	29	200
32	20 189 04.32	20 189 41.32	20 412 04.32	8.9	66	450
35	20 189 04.35	20 189 41.35	20 412 04.35	9.2	81	550
40	20 189 04.40	20 189 41.40	20 412 04.40	9.8	103	700
50	20 189 04.50	20 189 41.50	20 412 04.50	11.0	184	1 300
63	20 189 04.63	20 189 41.63	20 412 04.63	13.0	330	2 300
80	20 189 04.80	20 189 41.80	20 412 04.80	15.0	512	3 500
100	20 189 04.100	20 189 41.100	20 412 04.100	18.0	930	6 400
125	20 189 04.125	20 189 41.125	20 412 04.125	22.0	1 650	11 200
160	20 189 04.160	20 189 41.160	20 412 04.160	26.0	4 250	29 000
200	20 189 04.200	20 189 41.200	20 412 04.200	28.0	8 000	54 400
250	20 189 04.250	20 189 41.250	20 412 04.250	31.0	16 800	114 300

Cut-Off characteristics

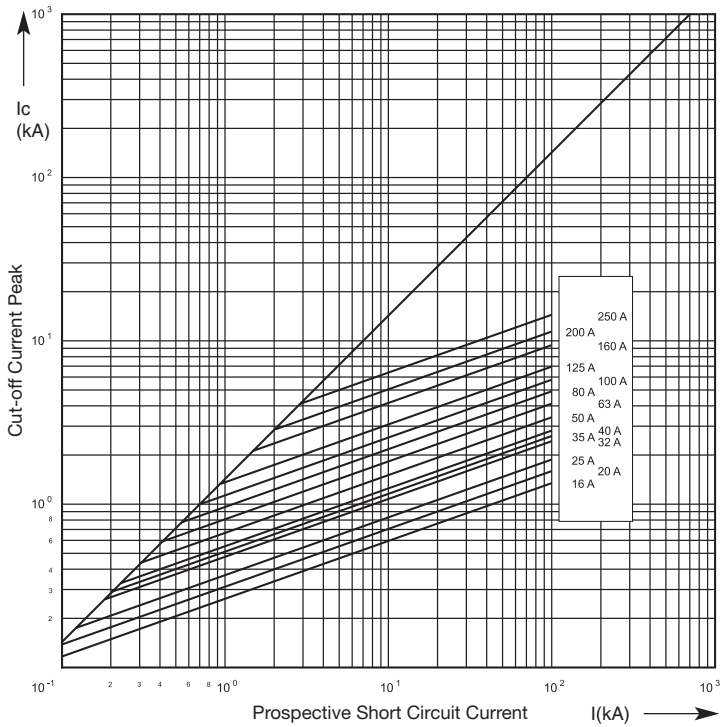

Time-Current Characteristics

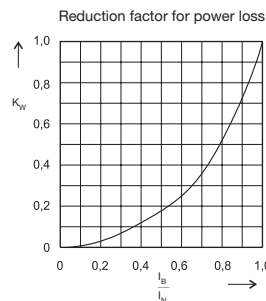
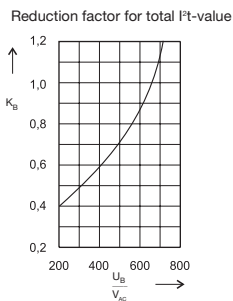
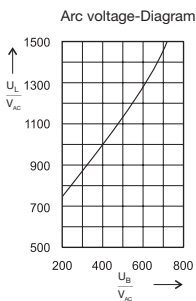
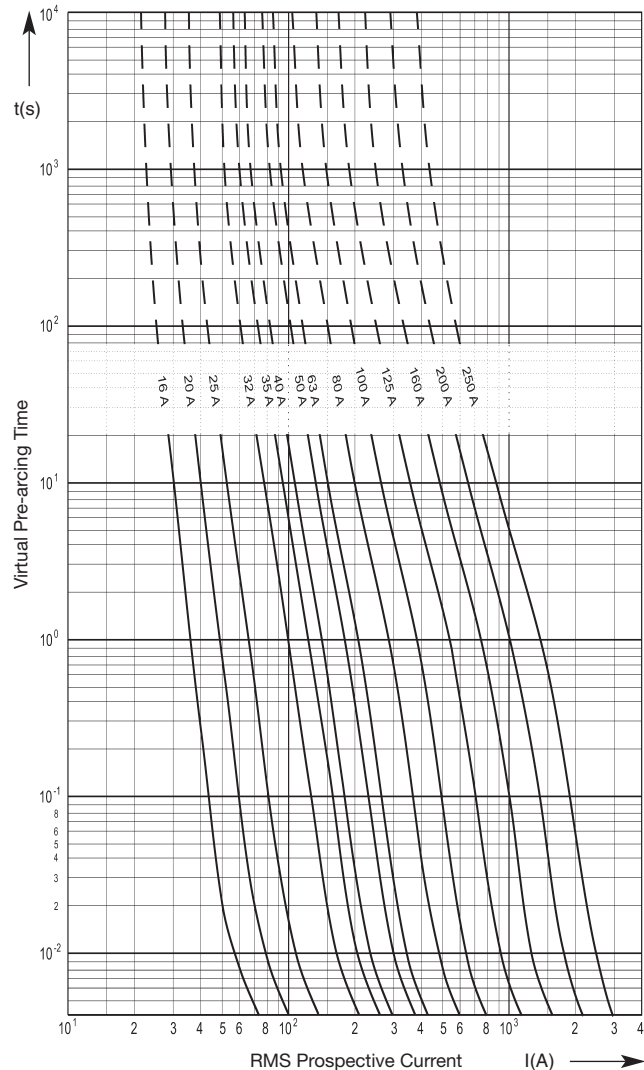

Size 00	Rated Voltage AC 690/700 V	Operating Class aR	Rated Breaking Capacity 600 V / 300 kA · 700 V / 200 kA
-------------------	--------------------------------------	------------------------------	---

Rated Current [A]	Part No. with Top Indicator	Part No. without Top Indicator	Part No. Fitting for Micro Switch	Power Loss [W]	Pre-arcing I ² t-value [A ² s]	Total I ² t-value @ 660 V [A ² s]
35	20 189 20.35	20 189 21.35	20 412 20.35	8	66	360
40	20 189 20.40	20 189 21.40	20 412 20.40	10	90	500
50	20 189 20.50	20 189 21.50	20 412 20.50	12	140	770
63	20 189 20.63	20 189 21.63	20 412 20.63	14	250	1 400
80	20 189 20.80	20 189 21.80	20 412 20.80	17	470	2 600
100	20 189 20.100	20 189 21.100	20 412 20.100	21	730	4 000
125	20 189 20.125	20 189 21.125	20 412 20.125	25	1 300	7 200
160	20 189 20.160	20 189 21.160	20 412 20.160	31	2 800	15 400
180	20 189 20.180	20 189 21.180	20 412 20.180	34	4 200	23 100
200	20 189 20.200	20 189 21.200	20 412 20.200	37	5 000	27 500
250	20 189 20.250	20 189 21.250	20 412 20.250	44	8 500	46 800
315	20 189 20.315	20 189 21.315	20 412 20.315	53	15 600	86 000
350	20 189 20.350	20 189 21.350	20 412 20.350	57	20 000	110 000
400	20 189 20.400	20 189 21.400	20 412 20.400	68	28 400	156 000

Cut-Off characteristics

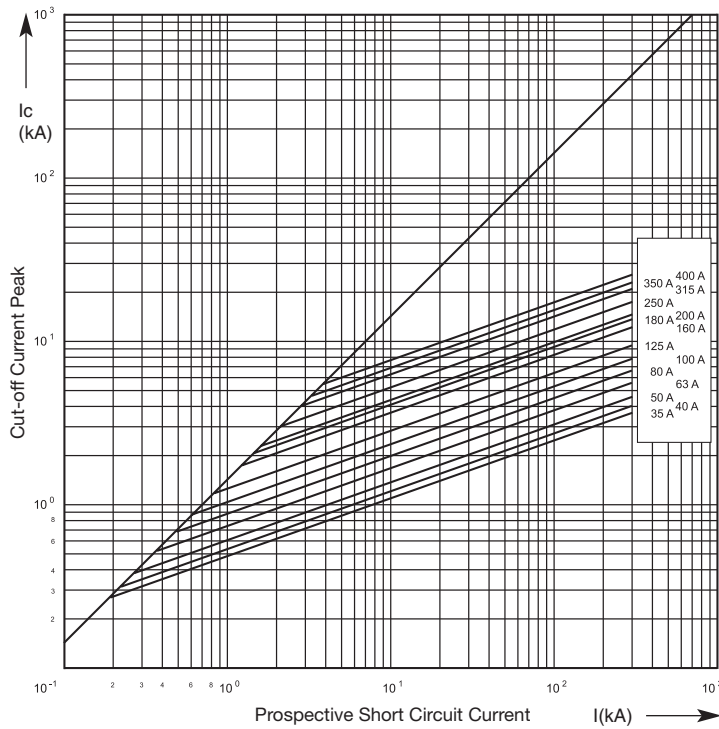

Time-Current Characteristics

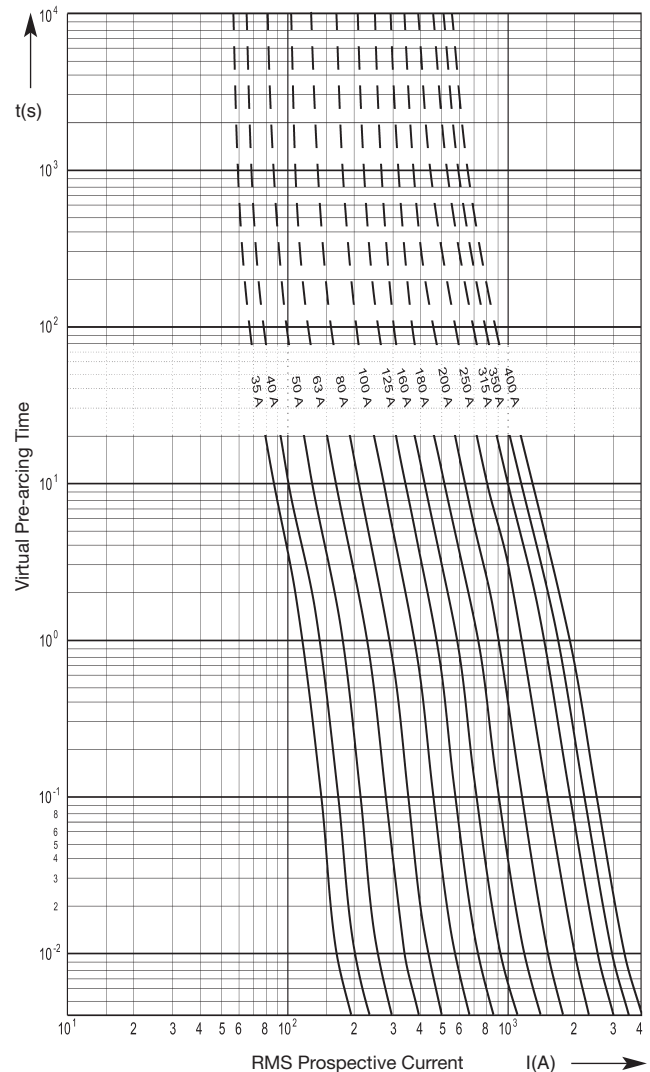

Arc voltage-Diagram

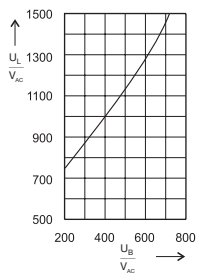

Reduction factor for total I²t-value

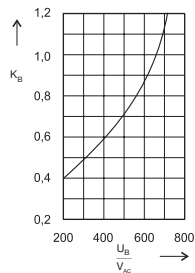

Reduction factor for power loss

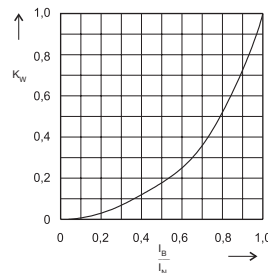

Size
00

Rated Voltage
AC 1000 V

Operating Class
aR

Rated Breaking Capacity
100 kA

Rated Current [A]	Part No. with Top Indicator	Part No. without Top Indicator	Part No. Fitting for Micro Switch	Power Loss [W]	Pre-arcing I ² t-value [A ² s]	Total I ² t-value at 1000 V [A ² s]
32	20 560 20.32	20 560 21.32	20 562 20.32	14	32	220
40	20 560 20.40	20 560 21.40	20 562 20.40	16	56	400
50	20 560 20.50	20 560 21.50	20 562 20.50	18	100	700
63	20 560 20.63	20 560 21.63	20 562 20.63	22	180	1 200
80	20 560 20.80	20 560 21.80	20 562 20.80	25	410	2 800
100	20 560 20.100	20 560 21.100	20 562 20.100	28	740	5 000
125	20 560 20.125	20 560 21.125	20 562 20.125	32	1 300	9 000
160	20 560 20.160	20 560 21.160	20 562 20.160	40	2 600	17 500
200	20 560 20.200	20 560 21.200	20 562 20.200	46	4 600	31 000
250	20 560 20.250	20 560 21.250	20 562 20.250	51	8 200	55 000
315*	20 560 20.315	20 560 21.315	20 562 20.315	59	16 000	106 000

* 900 Vac

Cut-Off characteristics

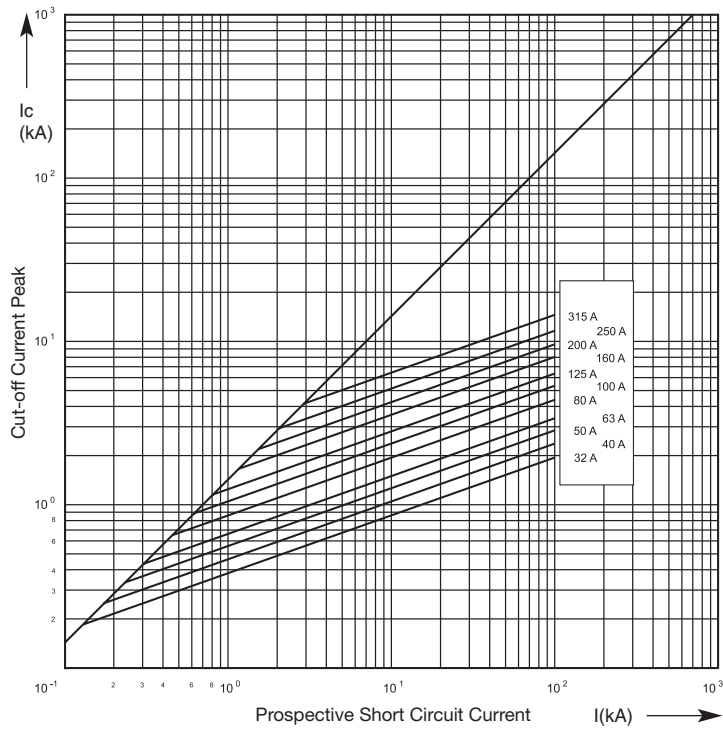

Time-Current Characteristics

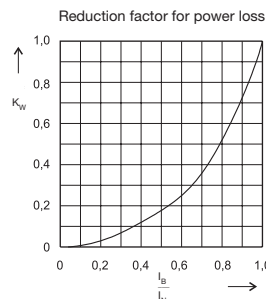
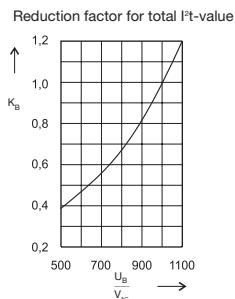
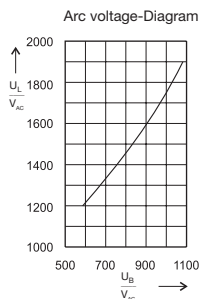
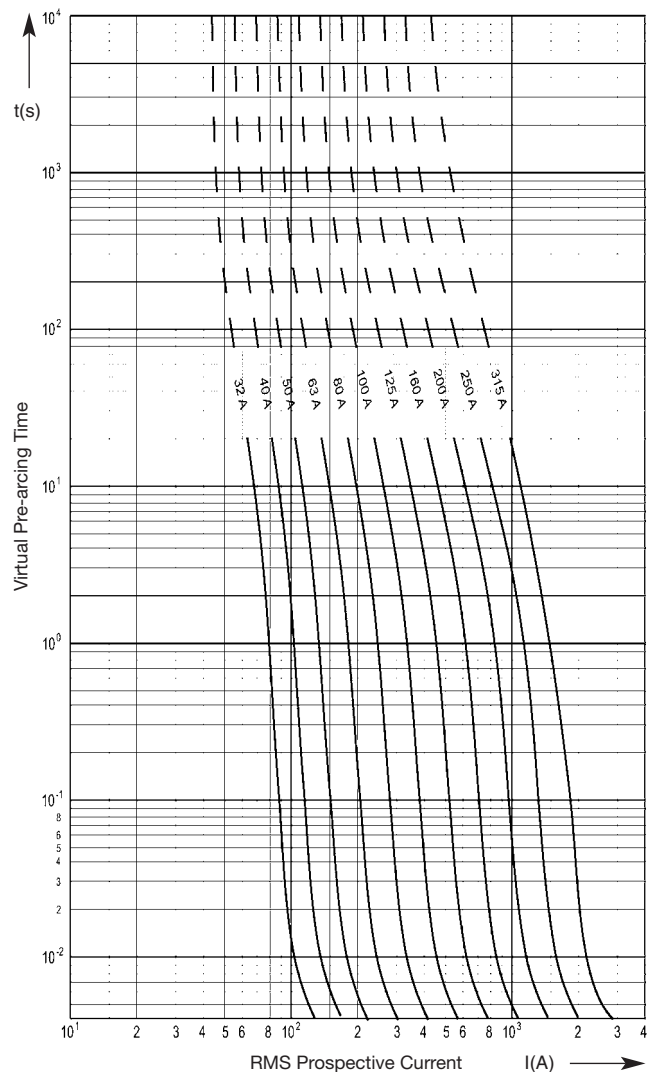

Fuse-Base 400 A Size **000 and 00** Rated Voltage **AC 1000 V** Standard **DIN 43653**

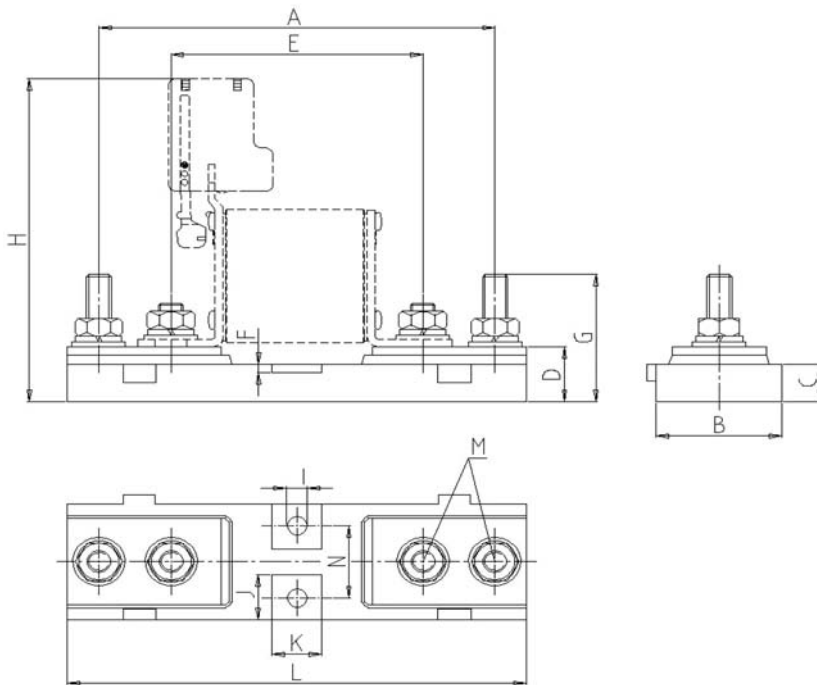

RU 1000 V
Part No. 21 189 01
Rated Current: 400 A
Rated Power Acceptance: 34 W
Nut Torque: 12 Nm

A	4.96" (126 mm)
B	1.57" (40 mm)
C	0.50" (13 mm)
D	0.75" (19 mm)
E	3.15" (80 mm)
F	0.12" (3 mm)
G	1.73" (44 mm)
H	4.40" (112 mm)
I	0.26" (6,5 mm)
J	0.60" (15,5 mm)
K	0.63" (16 mm)
L_(max)	5.75" (146 mm)
M	M 8
N	0.98" (25 mm)

Fuse-Base 400 A Size **000 and 00** Rated Voltage **AC 1000 V** Standard **DIN 43653**

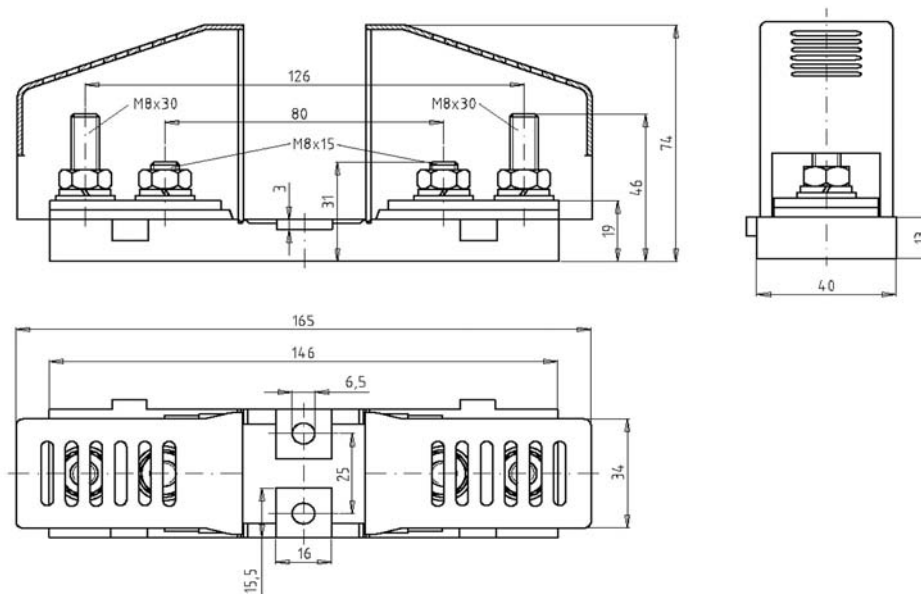

1000 V
Part No. 21 189 08
Rated Current: 400 A
Rated Power Acceptance: 34 W
Nut Torque: 12 Nm

with covers

Fuse-Base 400 A

Size
000 and 00

Rated Voltage
AC 1000 V

Standard
DIN 43653

RU 600 V
Part No. 21 189 11
Rated Current: 400 A
Rated Power Acceptance: 34 W
Nut Torque: 12 Nm

A	4.96" (126 mm)
B	1.57" (40 mm)
C	0.50" (13 mm)
D	0.75" (19 mm)
E	3.15" (80 mm)
F	0.12" (3 mm)
G1	2.00" (51 mm)
G2	1.73" (44 mm)
H	4.40" (112 mm)
I	0.26" (6,5 mm)
J	0.60" (15,5 mm)
K	0.63" (16 mm)
L_(max)	5.75" (146 mm)
M	M 8
N	0.98" (25 mm)

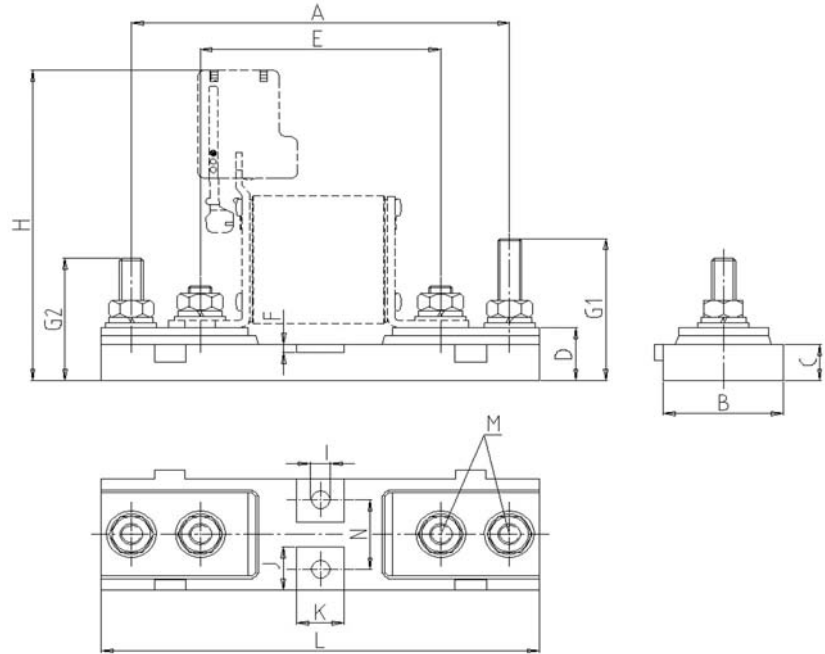

GL-Switch Rated Voltage **AC 250 V** **For Fuse-Links with Gripping Lugs**

Article Number	use for	Weight [kg]	Pack
28 002 01	NH00 DIN 80	0.02	10
28 002 02	NH000 DIN 80	0.02	10

Interrupting rating

AC 250 V	AC 250 V	DC 33 V	DC 26 V
ohmsch 5 A	ind. 3 A	ohmsch 3 A	L/R 10 ms 3 A

Terminals

AMP 2,8 x 0,5 (IEC 760)

Dimensions

Part No. 28 002 01 (Black Hammer)

Part No. 28 002 02 (Red Hammer)

