

**690/700 V NH 000 DIN 80**

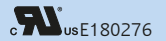

Verpackungseinheit / Packing unit: 6 Stück / 6 pieces

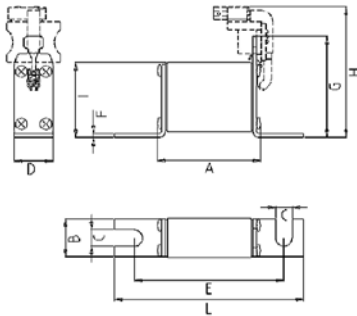

Betriebsklasse / Class <b>aR</b>	IEC 60 269-4 VDE 0636-4 UL 248-13
-------------------------------------	---

Artikel Nr. Article No.	Größe Size	Länge Length										
		In/A	A	B	C	D	E	F	G	H	I	L
		A	mm	mm	mm	mm	mm	mm	mm	mm	mm	mm
20 282 20	NH000/DIN 80	32-315	55	20	8,5	20,5	78	2	-	70	39	100
20 558 20*		350-400		28,8	10,3	29,5		2,5		80		105
20 282 20												
20 558 20*												

Bemessungsausschaltvermögen / Rated breaking capacity 200 kA @ 700 V

Bemessungsstrom Rated Current	Artikel Nr. Article No.		Gewicht Weight	Bemessungs- spannung Rated Voltage		Schmelz- integral Pre-Arcing- I <sup>2</sup> t-Value	Ausschalt- integral Total I <sup>2</sup> t-Value @ AC 660 V	Leistungs- abgabe Power Loss
	mit Kennmelder with indicator	für ext. Meldeschal- ter/ for ext. switch*		IEC 60269-4	UL 248-13			
	A			kg / 1	V			
32	20 282 20.32	20 558 20.32	0,14	690	700	52	290	8
35	20 282 20.35	20 558 20.35	0,14	690	700	66	360	9
40	20 282 20.40	20 558 20.40	0,14	690	700	90	500	10
50	20 282 20.50	20 558 20.50	0,14	690	700	140	770	12
63	20 282 20.63	20 558 20.63	0,14	690	700	250	1.400	14
80	20 282 20.80	20 558 20.80	0,14	690	700	470	2.600	18
100	20 282 20.100	20 558 20.100	0,14	690	700	730	4.000	22
110	20 282 20.110	20 558 20.110	0,14	690	700	890	4.900	24
125	20 282 20.125	20 558 20.125	0,14	690	700	1.300	7.200	26
150	20 282 20.150	20 558 20.150	0,14	690	700	2.000	11.000	29
160	20 282 20.160	20 558 20.160	0,14	690	700	2.800	15.400	32
180	20 282 20.180	20 558 20.180	0,14	690	700	3.700	20.400	35
200	20 282 20.200	20 558 20.200	0,14	690	700	4.500	25.000	39
225	20 282 20.225	20 558 20.225	0,14	690	700	6.600	37.000	44
250	20 282 20.250	20 558 20.250	0,14	690	700	8.000	44.000	47
315	20 282 20.315	20 558 20.315	0,14	690	700	14.000	77.000	58
350	20 282 20.350	20 558 20.350	0,14	500	-	23.800	@ AC 550 V 76.000	56
400	20 282 20.400	20 558 20.400	0,14	500	-	32.100	@ AC 550 V 106.000	70

\* Optional: GL-Meldeschal-ter siehe Seiten 43-44  
GL-switch see pages 43-44

Sicherungshalter siehe Seite 40  
Fuse-holder see page 40

Applikationskoeffizienten / Application coefficients (Weiterführende Informationen siehe Seite 13 / for more information see page 13)				
a	A2	B1 max.	B2	CF3
130	0,6	1,25	0,6	0,8

**690/700 V NH 000 DIN 80**

**RU** usE180276

**Zeit/Strom-Kennlinien**  
Time-current characteristics

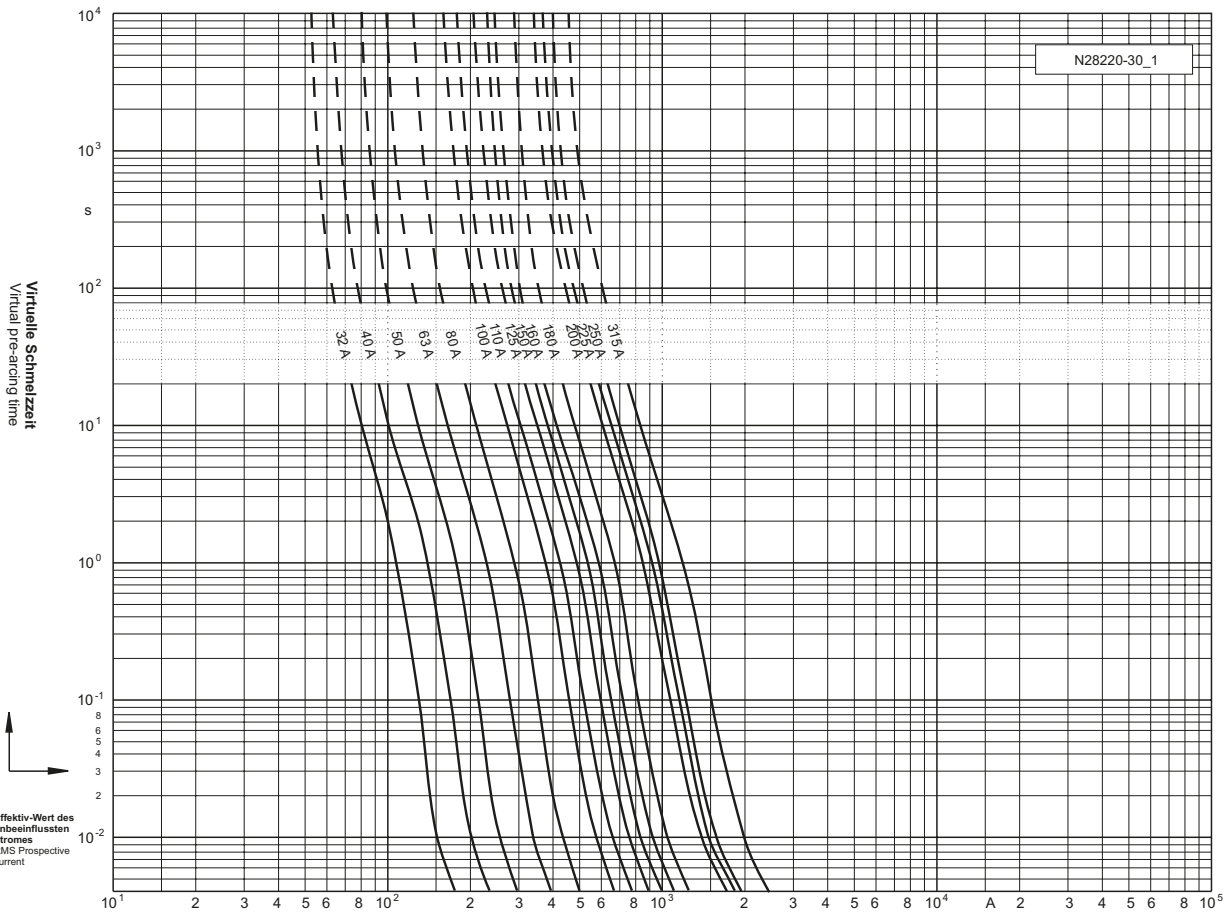

**Durchlass-Strom**  
Cut-off current

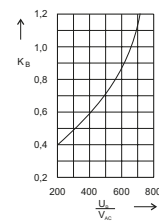
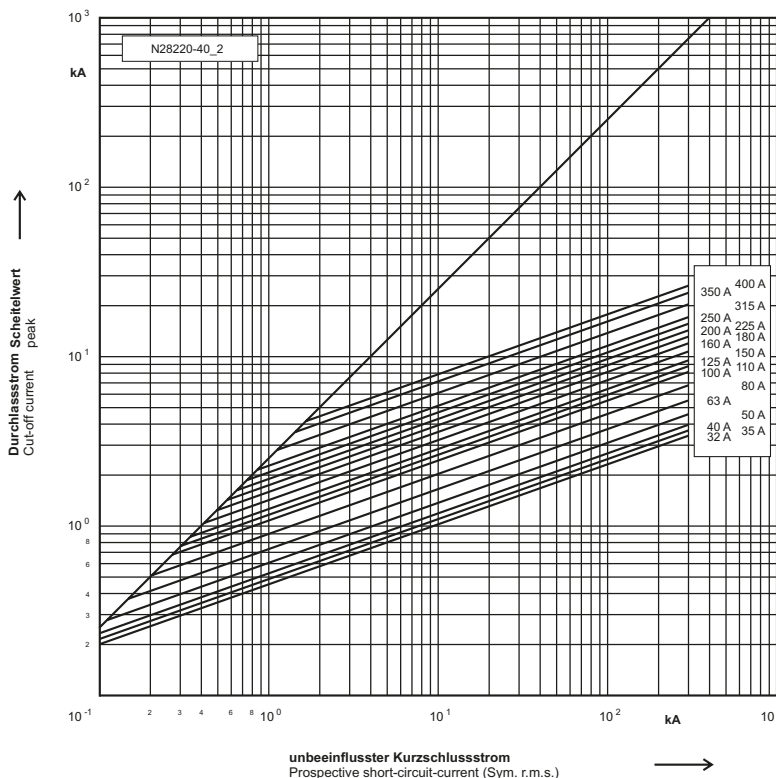

**Umrechnungsfaktor für den Ausschalt  $i^2t$ -Wert**  
Reduction factor for total  $i^2t$ -value

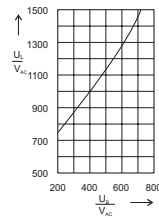

**Schaltspannungsdiagramm**  
Arc Voltage-Diagram

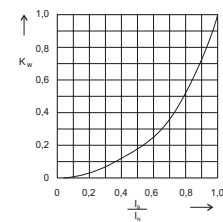

**Umrechnungsfaktor der Leistungsabgabe**  
Reduction factor for power Loss