

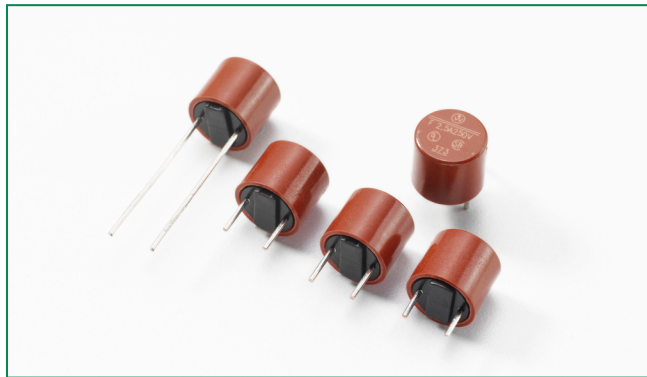



373 Series, TR5®, Fast-Acting Fuse



Agency Approvals

Agency	Agency File Number	Ampere Range
	File number: E 67006	50mA - 6.3A
	Certification: 51378	50mA - 6.3A
	File number: E67006	8A - 10A

Electrical Characteristics

% of Ampere Rating	Ampere Rating	Opening Time
200%	50mA - 6.3A	5 Seconds, Max.
	8A - 10A	60 Seconds, Max.

Description

The TR5® 373 Series are fast-acting 250V rated fuses, that are designed in accordance to UL 248-14.

Features

- Reduced PCB space requirements
- Direct solderable or plug-in versions
- Internationally approved
- Low internal resistance
- Shock safe casing
- Vibration resistant
- Halogen free
- Lead-free
- Available from 50mA to 10A

Applications

- Battery Chargers
- Consumer Electronics
- Power supplies
- Industrial Controllers

Additional Information



Datasheet





Resources



Samples

Electrical Characteristics

Amp Code	Rated Current	Voltage Rating	Breaking Capacity	Voltage Drop 1.0xI _N max. (mV)	Power Dissipation 1.0xI _N max. (mW)	Melting Integral 10xI _N max. (A ² s)	Agency Approvals		
									
0050	50mA	250V	50A / 250 VAC 50-60 Hz cos φ = 1.0	1400	70	0.0001	X	X	
0063	63mA	250V		1300	85	0.00023	X	X	
0080	80mA	250V		1200	100	0.00037	X	X	
0100	100mA	250V		1100	110	0.0013	X	X	
0125	125mA	250V		1000	125	0.0019	X	X	
0160	160mA	250V		950	155	0.004	X	X	
0200	200mA	250V		850	170	0.0065	X	X	
0250	250mA	250V		750	190	0.014	X	X	
0315	315mA	250V		650	205	0.032	X	X	
0400	400mA	250V		230	95	0.016	X	X	
0500	500mA	250V		220	110	0.025	X	X	
0630	630mA	250V		210	135	0.045	X	X	
0800	800mA	250V		200	160	0.069	X	X	
1100	1.00A	250V		190	190	0.125	X	X	
1125	1.25A	250V		180	225	0.2	X	X	
1160	1.60A	250V		170	275	0.38	X	X	
1200	2.00A	250V		160	320	0.63	X	X	
1250	2.50A	250V		150	375	1.2	X	X	
1315	3.15A	250V		140	445	1.9	X	X	
1400	4.00A	250V		130	520	3.5	X	X	
1500	5.00A	250V		120	630	6.2	X	X	
1630	6.30A	250V	115	1000	9.1	X	X		
1800	8.00A ¹	250V	120	1600	30			X	
2100	10.00A ¹	250V	110	2000	55			X	

1. Conducting path cross-section minimum ≥ 0.2mm²
 Note: 1.00 means the number one with two decimal places. 1,000 means the number one thousand.

Temperature Derating Curve

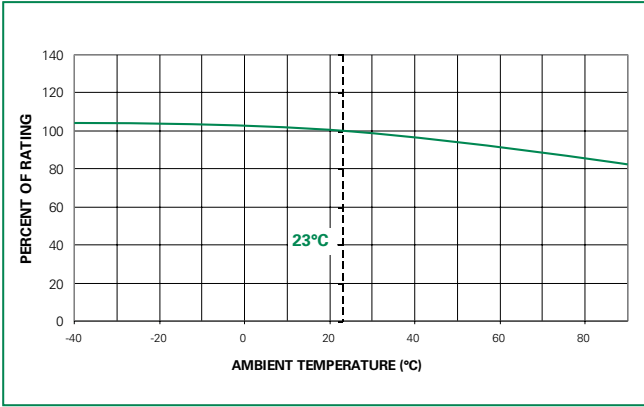

Average Time Current Curves

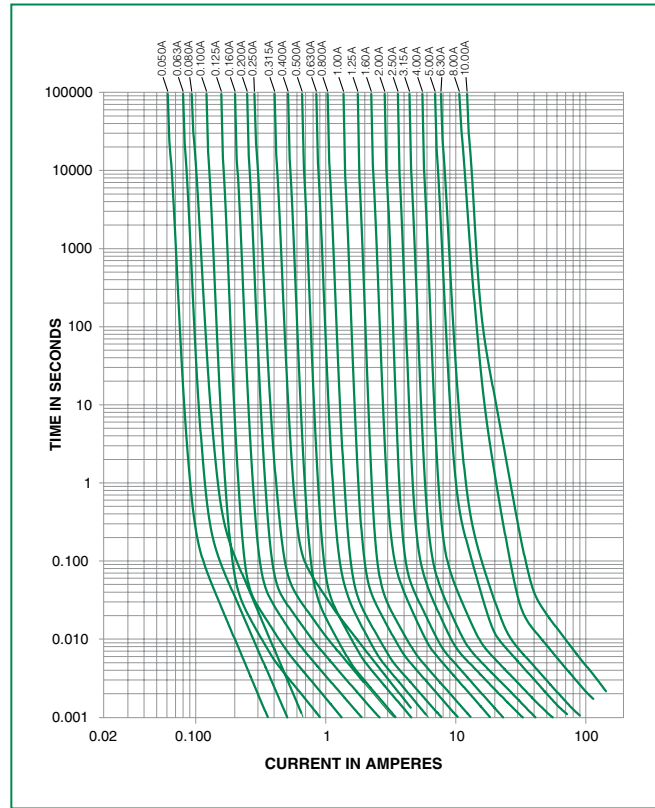

Soldering Parameters - Wave Soldering

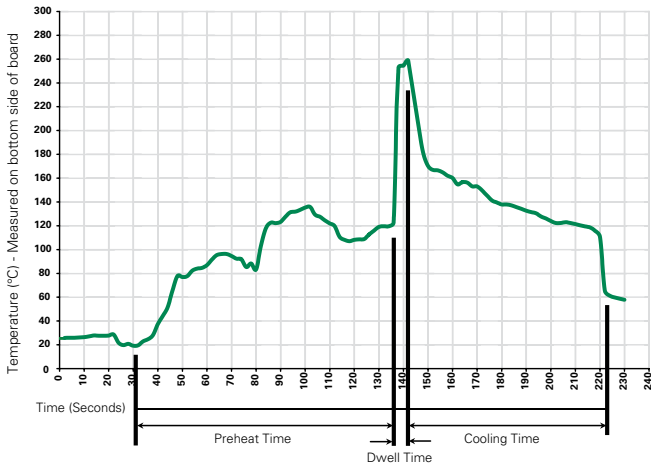

Recommended Process Parameters:

Wave Parameter	Lead-Free Recommendation
Preheat: (Depends on Flux Activation Temperature)	(Typical Industry Recommendation)
Temperature Minimum:	100° C
Temperature Maximum:	150° C
Preheat Time:	60-180 seconds
Solder Pot Temperature:	260° C Maximum
Solder Dwell Time:	2-5 seconds

Recommended Hand-Solder Parameters:

Solder Iron Temperature: 350° C +/- 5° C
Heating Time: 5 seconds max.

Note: These devices are not recommended for IR or Convection Reflow process.

Product Characteristics

Materials	Base/Cap: Brown Thermoplastic Polyamide PA 6.6, UL 94 V-0 Round Pins: Copper, Tin-plated
Lead Pull Strength	10 N (EN 60068-2-21)
Solderability	260°C, ≤ 3s. (Wave) 350°C, ≤ 1s. (Soldering Iron)
Soldering Heat Resistance	260°C, 10s. (IEC 60068-2-20) 350°C, 3s. (Soldering Iron)

Operating Temperature	-40°C to +85°C (consider de-rating)
Climatic Category	-40°C/+85°C/21 days (EN 60068-1,-2-1,-2-2,-2-78)
Stock Conditions	+10°C to +60°C RH ≤ 75% yearly average, without dew, maximum value for 30 days-95%
Vibration Resistance	24 cycles at 15 min. each (EN 60068-2-6) 10 - 60 Hz at 0.75 mm amplitude 60 - 2000 Hz at 10G's acceleration

Dimensions

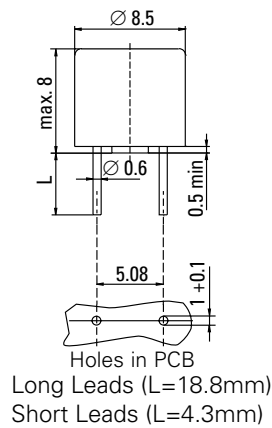

Part Numbering System

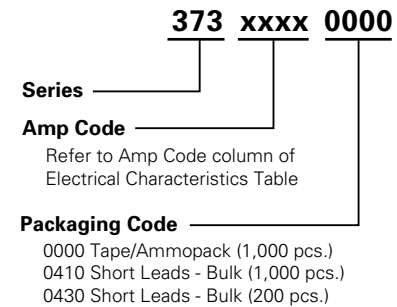

Packaging

Packaging Option	Packaging Specification	Quantity	Quantity & Packaging Code	Taping Width
373 Series				
Bulk	N/A	1,000	MX	N/A
Bulk	N/A	1,000	MXE	N/A