

Bridge Rectifiers

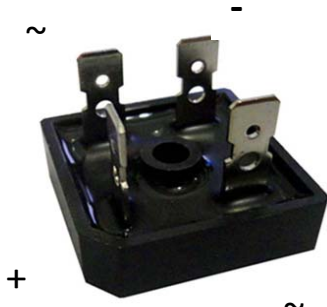

Features

- UL recognition file number E230084
- High-Reliability
- Heat Resistance
- Low IR
- Solder dip 275 °C max. 7 s, per JESD 22-B106

Typical Applications

General purpose use in AC/DC bridge full wave rectification for power supply, home appliances, office equipment, industrial automation applications.

Mechanical Data

- **Package:** S25VB
Molding compound meets UL 94 V-0 flammability rating, RoHS- compliant
- **Terminals:** Tin plated leads, solderable per J-STD-002 and JESD22-B102

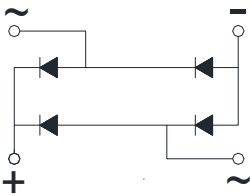

■ Maximum Ratings (T_a=25°C Unless otherwise specified)

PARAMETER	SYMBOL	UNIT	S35VB10	S35VB20	S35VB40	S35VB60	S35VB80	S35VB100	S35VB120
Device marking code			S35VB10	S35VB20	S35VB40	S35VB60	S35VB80	S35VB100	S35VB120
Repetitive Peak Reverse Voltage	V _{RRM}	V	100	200	400	600	800	1000	1200
Average Rectified Output Current @60Hz sine wave, R-load, With heatsink T _c =85°C	I _O	A	35						
Surge(Non-repetitive)Forward Current @60HZ Half- sine Wave, 1 cycle, T _a =25°C	I _{FSM}	A	500						
Current Squared Time @1ms≤t<8.3ms T _j =25°C, Rating of per diode	I ² t	A ² S	1040						
Storage Temperature	T _{stg}	°C	-55~+150						
Junction Temperature	T _j	°C	-55 ~+150						
Dielectric Strength, Terminals to case, AC 1 minute	V _{dis}	KV	2.5						
Mounting Torque	TOR	kgcm	10						

■ Electrical Characteristics (T_a=25°C Unless otherwise specified)

PARAMETER	SYMBOL	UNIT	TEST CONDITIONS	S35VB10	S35VB20	S35VB40	S35VB60	S35VB80	S35VB100	S35VB120
Maximum instantaneous forward voltage drop per diode	V _{FM}	V	I _{FM} =17.5A	1.05						
Maximum DC reverse current at rated DC blocking voltage per diode	I _{RRM}	μA	V _{RM} =V _{RRM}	10						

■ Thermal Characteristics (T_a=25°C Unless otherwise specified)

PARAMETER	SYMBOL	UNIT	S35VB10	S35VB20	S35VB40	S35VB60	S35VB80	S35VB100	S35VB120
Thermal Resistance Between junction and case, With heatsink	R _{θ J-C}	°C/W	1.0						



S35VB10 THRU S35VB120

Ordering Information (Example)

PREFERED P/N	PACKAGE CODE	UNIT WEIGHT(g)	MINIMUM PACKAGE(pcs)	INNER BOX QUANTITY(pcs)	OUTER CARTON QUANTITY(pcs)	DELIVERY MODE
S35VB10~S35VB120	A1	Approximate 20	50	50	500	Paper Box

Characteristics (Typical)

FIG1:Io-Tc Curve

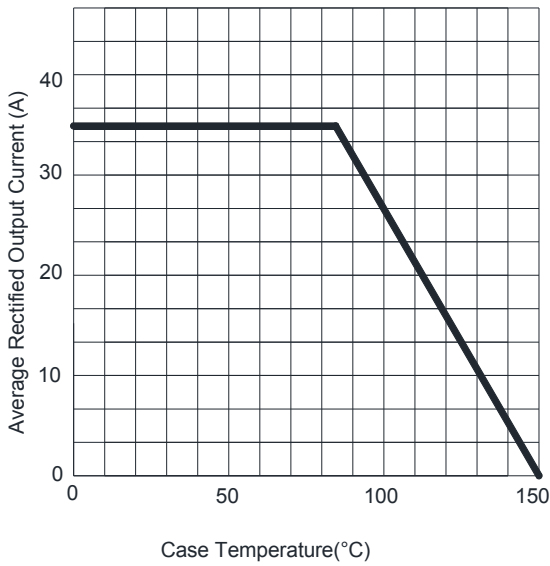

FIG2:Surge Forward Current Capability

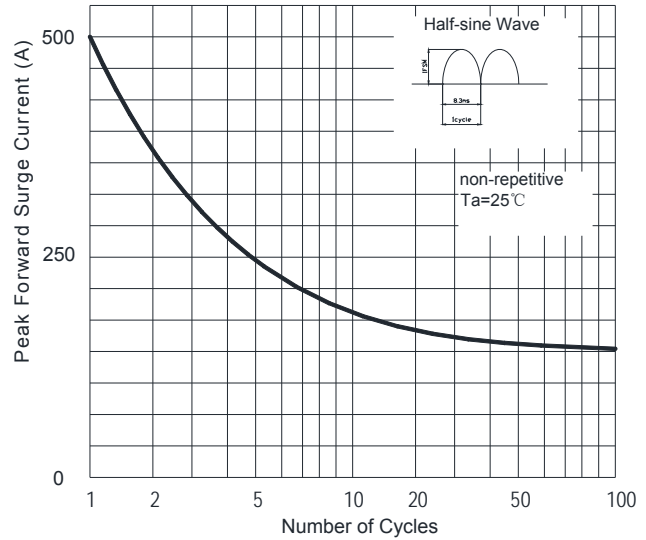

FIG3:Instantaneous Forward Voltage

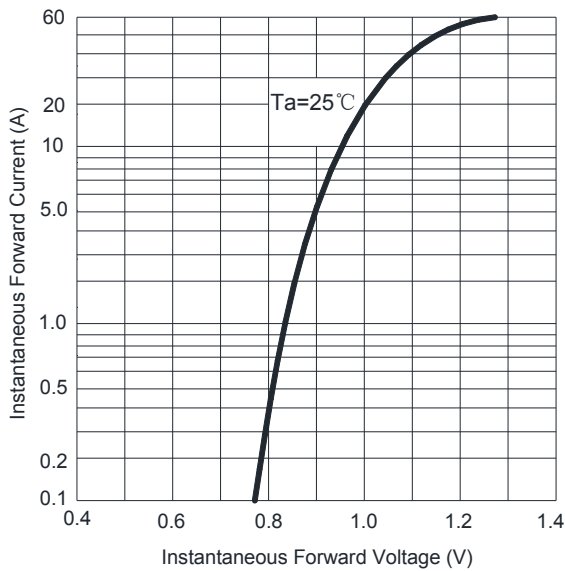
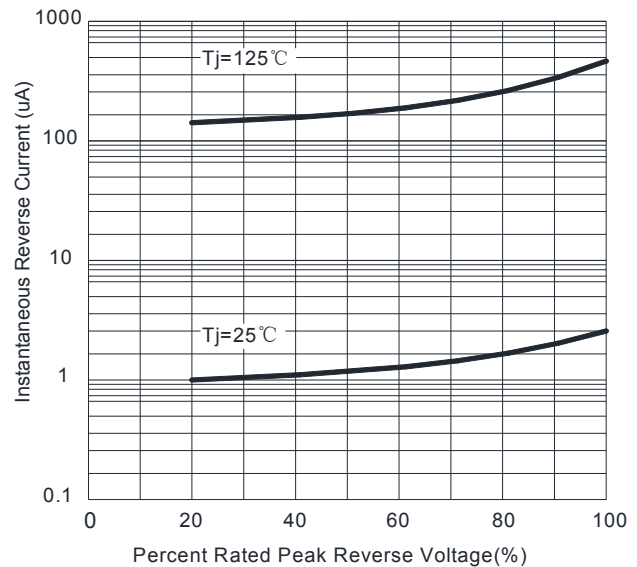

FIG4:Typical Reverse Characteristics





S35VB10 THRU S35VB120

■ Outline Dimensions

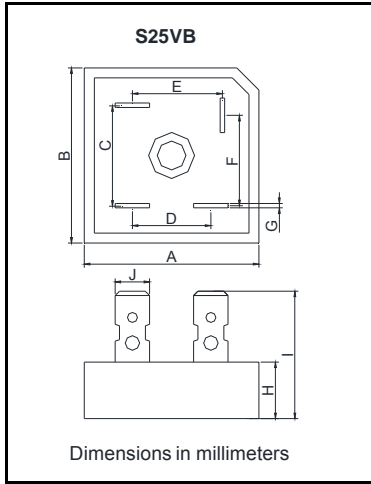

S25VB		
Dim	Min	Max
A	31.1	32.1
B	31.1	32.1
C	17.6	18.6
D	13.7	14.7
E	15.8	16.8
F	15.8	16.8
G	0.75	0.85
H	9.5	10.5
I	/	25
J	6.2	6.4



Disclaimer

The information presented in this document is for reference only. Yangzhou Yangjie Electronic Technology Co., Ltd. reserves the right to make changes without notice for the specification of the products displayed herein to improve reliability, function or design or otherwise.

The product listed herein is designed to be used with ordinary electronic equipment or devices, and not designed to be used with equipment or devices which require high level of reliability and the malfunction of which would directly endanger human life (such as medical instruments, transportation equipment, aerospace machinery, nuclear-reactor controllers, fuel controllers and other safety devices), Yangjie or anyone on its behalf, assumes no responsibility or liability for any damages resulting from such improper use of sale.

This publication supersedes & replaces all information previously supplied. For additional information, please visit our website [http:// www.21yangjie.com](http://www.21yangjie.com) , or consult your nearest Yangjie's sales office for further assistance.