

## Bridge Rectifiers

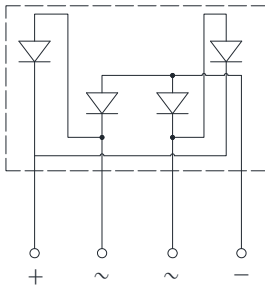
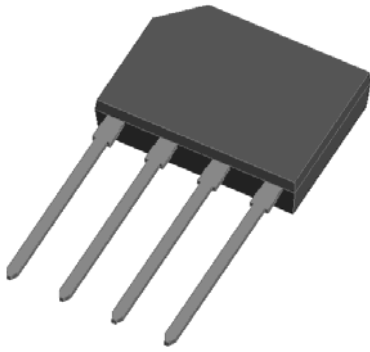

### Features

- UL recognition, file #E230084
- Ideal for printed circuit boards
- High surge current capability
- Solder dip 275 °C max. 7 s, per JESD 22-B106

### Typical Applications

General purpose use in AC/DC bridge full wave rectification for monitor, TV, printer, power supply, switching mode power supply, adapter, audio equipment, and home appliances applications.

### Mechanical Data

- **Package:** GBP  
Molding compound meets UL 94 V-0 flammability rating, RoHS-compliant
- **Terminals:** Tin plated leads, solderable per J-STD-002 and JESD22-B102
- **Polarity:** As marked on body

### ■ Maximum Ratings (T<sub>a</sub>=25°C Unless otherwise specified)

PARAMETER	SYMBOL	UNIT	GBP2005	GBP201	GBP202	GBP204	GBP206	GBP208	GBP210
Device marking code			GBP2005	GBP201	GBP202	GBP204	GBP206	GBP208	GBP210
Repetitive peak reverse voltage	VRRM	V	50	100	200	400	600	800	1000
Average rectified output current @60Hz sine wave, R-load	With heatsink T <sub>c</sub> =140°C	I <sub>O</sub>	A	2.0					
	Without heatsink T <sub>c</sub> =70°C								
Surge(non-repetitive)forward current @60Hz half sine wave, 1 cycle, T <sub>j</sub> =25°C	IFSM	A	60						
Current squared time @1ms≤t≤8.3ms T <sub>j</sub> =25°C, Rating of per diode	I <sup>2</sup> t	A <sup>2</sup> s	15						
Storage temperature	T <sub>stg</sub>	°C	-55 ~+150						
Junction temperature	T <sub>j</sub>	°C	-55 ~+150						

### ■ Electrical Characteristics (T<sub>a</sub>=25°C Unless otherwise specified)

PARAMETER	SYMBOL	UNIT	TEST CONDITIONS	GBP2005	GBP201	GBP202	GBP204	GBP206	GBP208	GBP210
Maximum instantaneous forward voltage drop per diode	V <sub>F</sub>	V	I <sub>FM</sub> =1A	1.05						
Maximum DC reverse current at rated DC blocking voltage per diode	I <sub>R</sub> RM	μA	V <sub>RM</sub> =VRRM	10						

### ■ Thermal Characteristics (T<sub>a</sub>=25°C Unless otherwise specified)

PARAMETER	SYMBOL	UNIT	GBP2005	GBP201	GBP202	GBP204	GBP206	GBP208	GBP210
Thermal Resistance	Between junction and ambient	R <sub>θJ-A</sub>	°C/W	47					
	Between junction and lead	R <sub>θJ-L</sub>		10					



# GBP2005 THRU GBP210

## Ordering Information (Example)

PREFERRED P/N	PACKING CODE	UNIT WEIGHT(g)	MINIIMUM PACKAGE(pcs)	INNER BOX QUANTITY(pcs)	OUTER CARTON QUANTITY(pcs)	DELIVERY MODE
GBP2005-GBP210	B1	1.37	35	3500	7000	TUBE
GBP2005-GBP210	A1	1.37	500	500	5000	BOX

## Characteristics (Typical)

FIG1:Io-Tc Curve

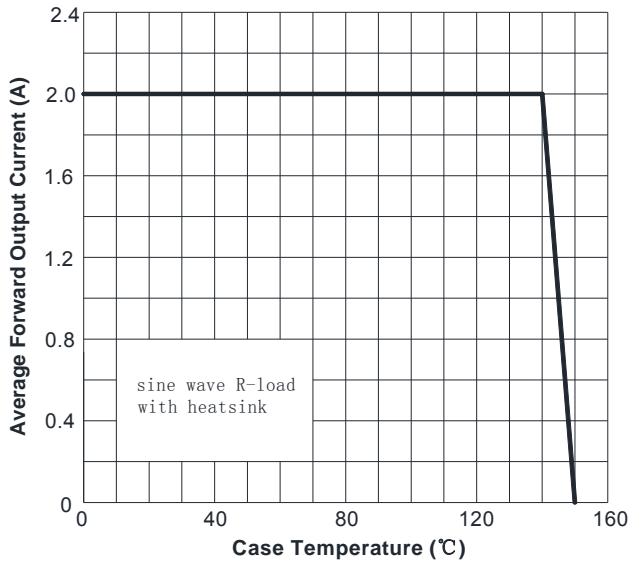

FIG2: Surge Forward Current Capability

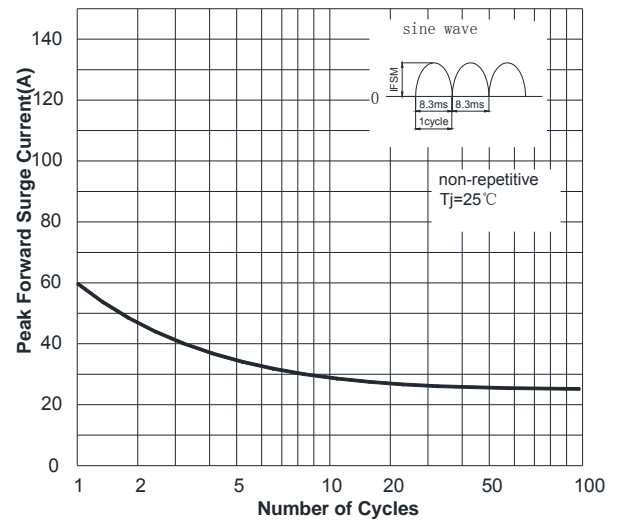

FIG3: Forward Voltage

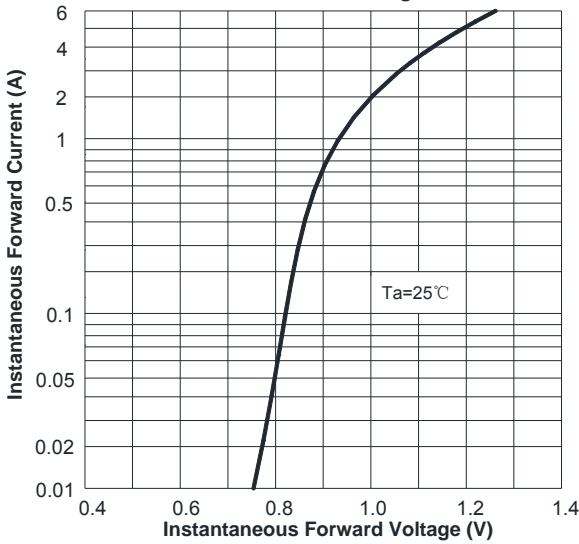
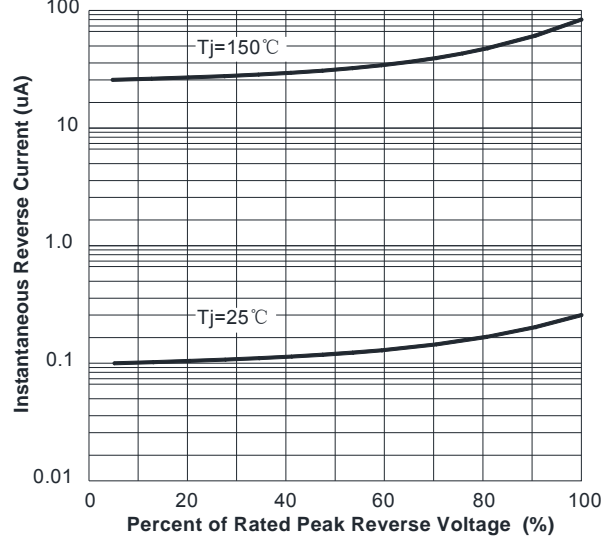
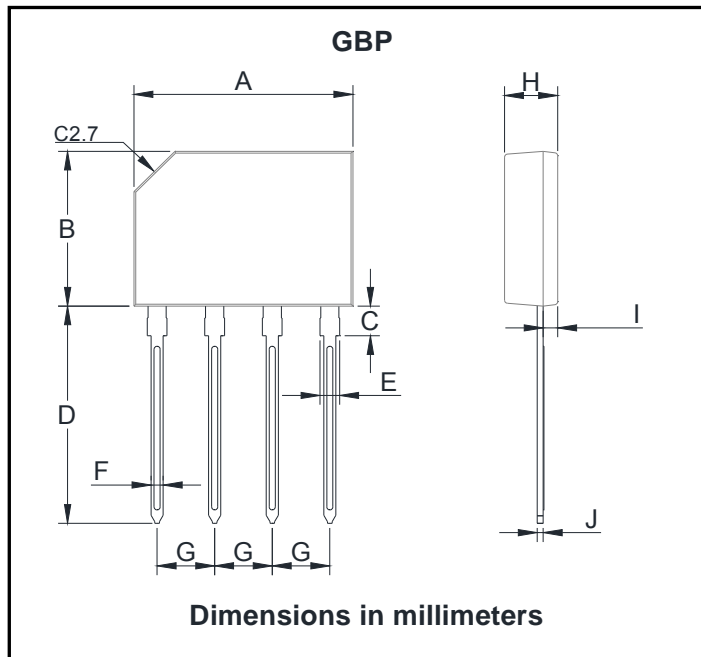

FIG4: Typical Reverse Characteristics





## ■ Outline Dimensions



GBP		
Dim	Min	Max
A	14.25	14.75
B	10.10	10.60
C	1.80	2.20
D	14.25	14.73
E	1.22	1.42
F	0.76	0.86
G	3.70	3.90
H	3.35	3.65
I	0.80	1.10
J	0.35	0.55



### Disclaimer

The information presented in this document is for reference only. Yangzhou Yangjie Electronic Technology Co., Ltd. reserves the right to make changes without notice for the specification of the products displayed herein to improve reliability, function or design or otherwise.

The product listed herein is designed to be used with ordinary electronic equipment or devices, and not designed to be used with equipment or devices which require high level of reliability and the malfunction of which would directly endanger human life (such as medical instruments, transportation equipment, aerospace machinery, nuclear-reactor controllers, fuel controllers and other safety devices), Yangjie or anyone on its behalf, assumes no responsibility or liability for any damages resulting from such improper use of sale.

This publication supersedes & replaces all information previously supplied. For additional information, please visit our website [http:// www.21yangjie.com](http://www.21yangjie.com) , or consult your nearest Yangjie's sales office for further assistance.