

# Standard Rectifier Module

<b>3~ Rectifier</b>	
$V_{RRM}$	= 1800 V
$I_{DAV}$	= 60 A
$I_{FSM}$	= 550 A

## 3~ Rectifier Bridge

Part number

**VUO62-18NO7**



E72873



### Features / Advantages:

- Package with DCB ceramic
- Improved temperature and power cycling
- Planar passivated chips
- Very low forward voltage drop
- Very low leakage current

### Applications:

- Diode for main rectification
- For three phase bridge configurations
- Supplies for DC power equipment
- Input rectifiers for PWM inverter
- Battery DC power supplies
- Field supply for DC motors

### Package: PWS-D

- Industry standard outline
- RoHS compliant
- Easy to mount with two screws
- Base plate: Copper internally DCB isolated
- Advanced power cycling

Rectifier				Ratings		
Symbol	Definition	Conditions	min.	typ.	max.	Unit
$V_{RSM}$	max. non-repetitive reverse blocking voltage	$T_{VJ} = 25^{\circ}C$			1900	V
$V_{RRM}$	max. repetitive reverse blocking voltage	$T_{VJ} = 25^{\circ}C$			1800	V
$I_R$	reverse current	$V_R = 1800 V$	$T_{VJ} = 25^{\circ}C$		40	$\mu A$
		$V_R = 1800 V$	$T_{VJ} = 150^{\circ}C$		1.5	mA
$V_F$	forward voltage drop	$I_F = 20 A$	$T_{VJ} = 25^{\circ}C$		1.07	V
		$I_F = 60 A$			1.30	V
		$I_F = 20 A$	$T_{VJ} = 125^{\circ}C$		0.96	V
		$I_F = 60 A$			1.27	V
$I_{DAV}$	bridge output current	$T_C = 120^{\circ}C$ rectangular $d = 1/3$	$T_{VJ} = 150^{\circ}C$		60	A
$V_{FO}$	threshold voltage	} for power loss calculation only	$T_{VJ} = 150^{\circ}C$		0.78	V
$r_F$	slope resistance				8.1	m $\Omega$
$R_{thJC}$	thermal resistance junction to case				1.1	K/W
$R_{thCH}$	thermal resistance case to heatsink			0.4		K/W
$P_{tot}$	total power dissipation		$T_C = 25^{\circ}C$		110	W
$I_{FSM}$	max. forward surge current	$t = 10 ms; (50 Hz), sine$	$T_{VJ} = 45^{\circ}C$		550	A
		$t = 8,3 ms; (60 Hz), sine$	$V_R = 0 V$		595	A
		$t = 10 ms; (50 Hz), sine$	$T_{VJ} = 150^{\circ}C$		470	A
		$t = 8,3 ms; (60 Hz), sine$	$V_R = 0 V$		505	A
$I^2t$	value for fusing	$t = 10 ms; (50 Hz), sine$	$T_{VJ} = 45^{\circ}C$		1.52	kA <sup>2</sup> s
		$t = 8,3 ms; (60 Hz), sine$	$V_R = 0 V$		1.48	kA <sup>2</sup> s
		$t = 10 ms; (50 Hz), sine$	$T_{VJ} = 150^{\circ}C$		1.11	kA <sup>2</sup> s
		$t = 8,3 ms; (60 Hz), sine$	$V_R = 0 V$		1.06	kA <sup>2</sup> s
$C_J$	junction capacitance	$V_R = 400 V; f = 1 MHz$	$T_{VJ} = 25^{\circ}C$		19	pF

Package PWS-D			Ratings			
Symbol	Definition	Conditions	min.	typ.	max.	Unit
$I_{RMS}$	RMS current	per terminal			150	A
$T_{stg}$	storage temperature		-40		125	°C
$T_{VJ}$	virtual junction temperature		-40		150	°C
<b>Weight</b>				159		g
$M_D$	mounting torque		4.25		5.75	Nm
$M_T$	terminal torque		4.25		5.75	Nm
$d_{Spp/App}$	creepage distance on surface   striking distance through air	terminal to terminal	9.5			mm
$d_{Spb/Appb}$		terminal to backside	26.0			mm
$V_{ISOL}$	isolation voltage	t = 1 second	3000			V
		t = 1 minute	2500			V

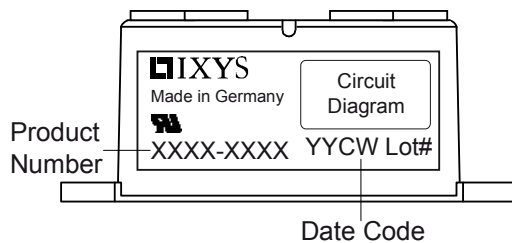

Ordering	Part Number	Marking on Product	Delivery Mode	Quantity	Code No.
Standard	VUO62-18NO7	VUO62-18NO7	Box	10	460486

### Equivalent Circuits for Simulation

\* on die level

$T_{VJ} = 150\text{ °C}$



Rectifier

$V_{0\ max}$	threshold voltage	0.78	V
$R_{0\ max}$	slope resistance *	6.9	mΩ

**Outlines PWS-D**

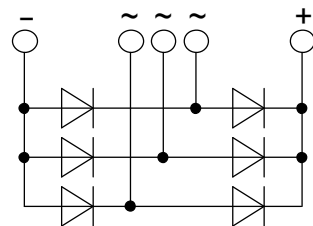
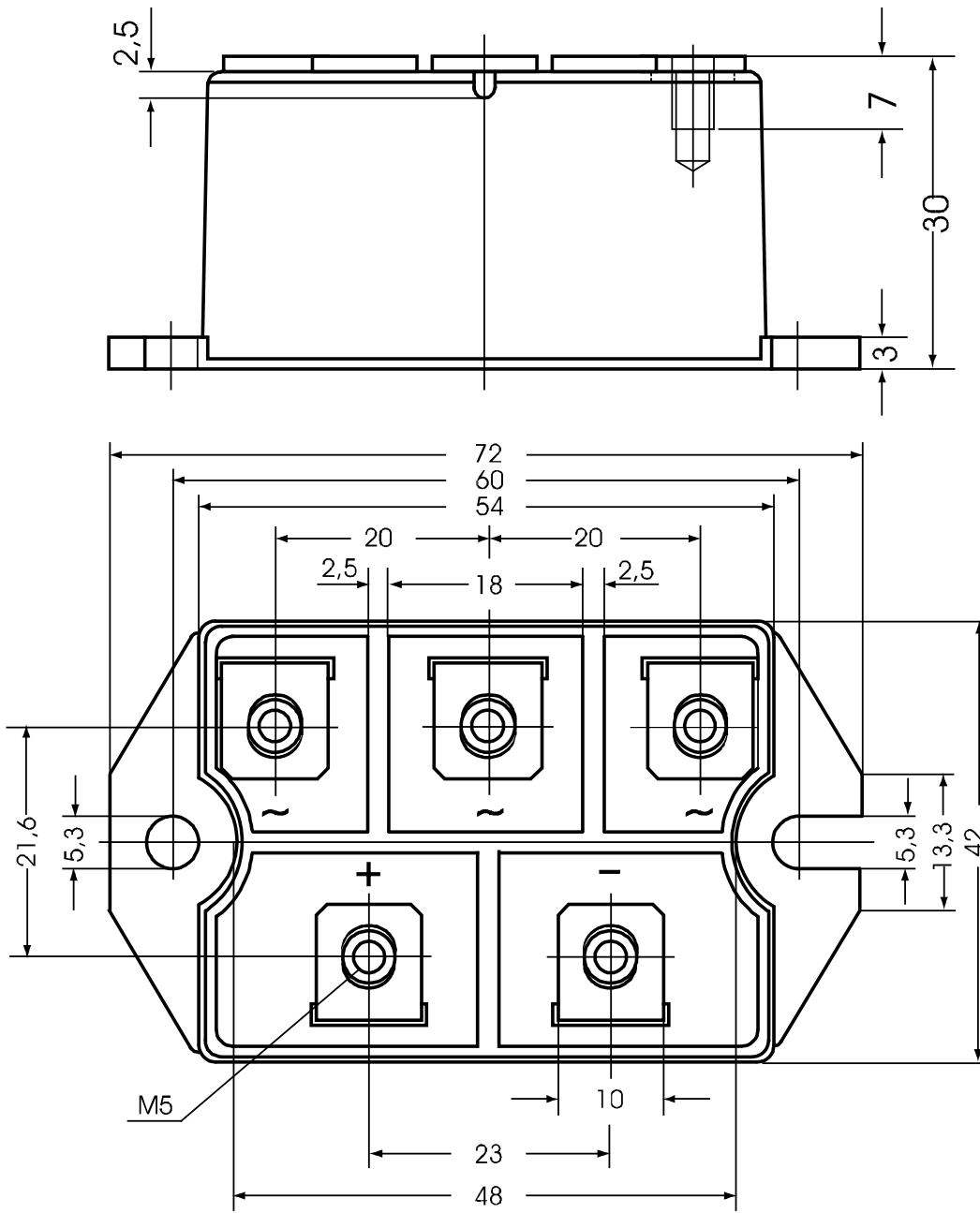

## Rectifier

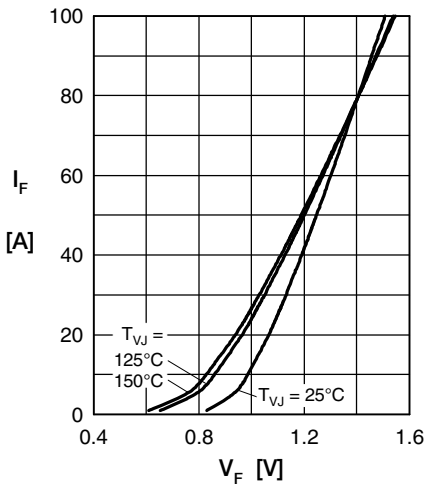

Fig. 1 Forward current vs. voltage drop per diode

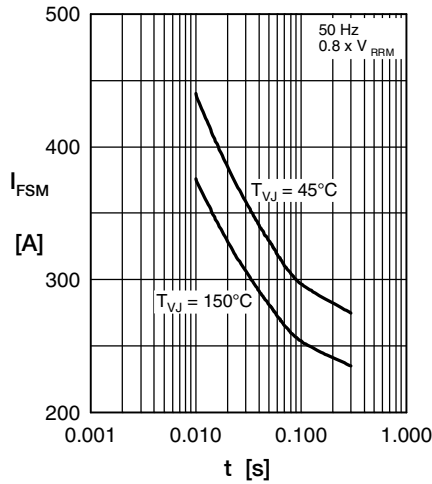

Fig. 2 Surge overload current vs. time per diode

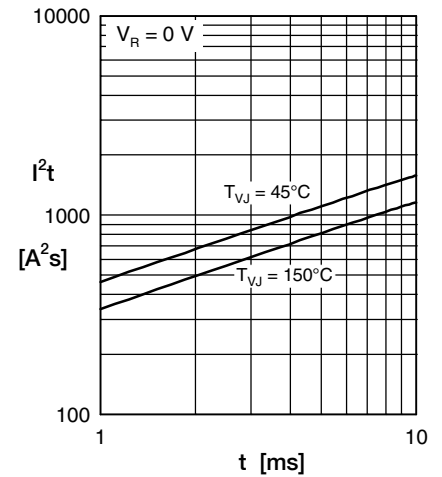

Fig. 3  $I^2t$  vs. time per diode

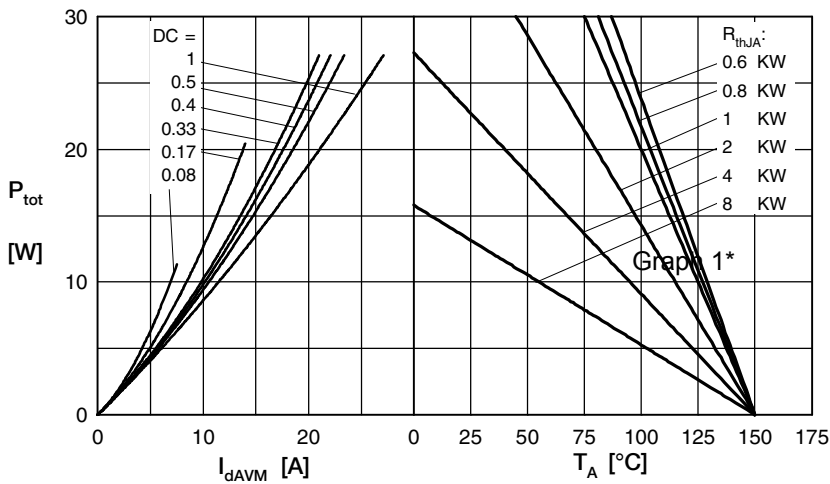

Fig. 4 Power dissipation vs. forward current and ambient temperature per diode

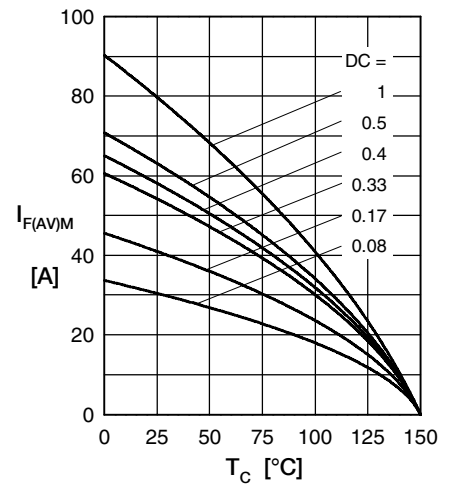

Fig. 5 Max. forward current vs. case temperature per diode

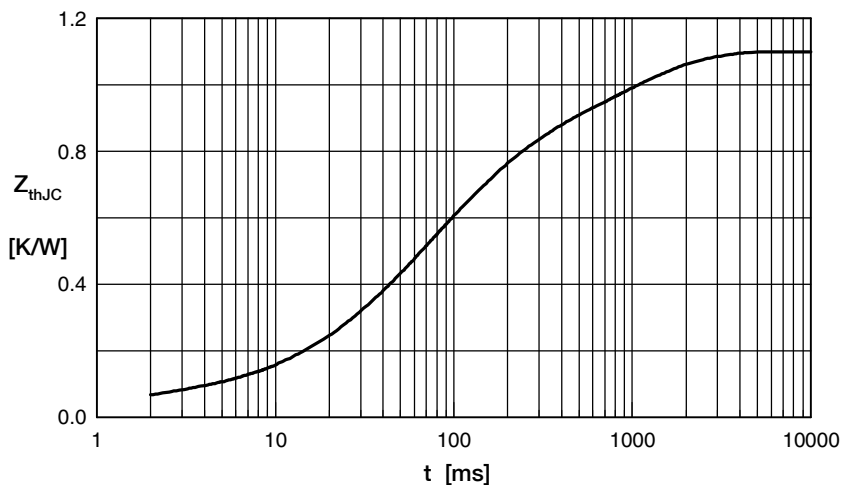

Fig. 6 Transient thermal impedance junction to case vs. time per diode

Constants for  $Z_{thJC}$  calculation:

i	$R_{th}$ (K/W)	$t_i$ (s)
1	0.05	0.001
2	0.14	0.030
3	0.25	0.060
4	0.35	0.130
5	0.31	0.920