

Standard Rectifier Module

3~ Rectifier	
V_{RRM}	= 1600 V
I_{DAV}	= 75 A
I_{FSM}	= 700 A

3~ Rectifier Bridge

Part number

VUO60-16NO3

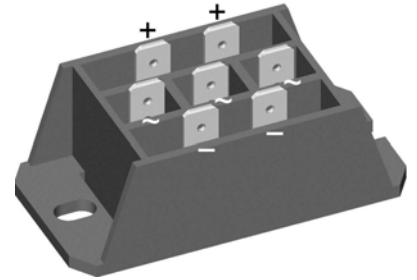

 E72873

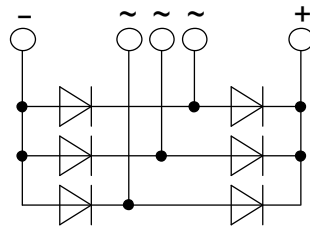

Features / Advantages:

- Package with DCB ceramic
- Reduced weight
- Improved temperature and power cycling
- Planar passivated chips
- Very low forward voltage drop
- Very low leakage current

Applications:

- Diode for main rectification
- For three phase bridge configurations
- Supplies for DC power equipment
- Input rectifiers for PWM inverter
- Battery DC power supplies
- Field supply for DC motors

Package: FO-F-B

- Isolation Voltage: 3600V~
- Industry standard outline
- RoHS compliant
- ¼" fast-on terminals
- Easy to mount with two screws
- Base plate: DCB ceramic
- Reduced weight
- Advanced power cycling

Rectifier				Ratings			
Symbol	Definition	Conditions		min.	typ.	max.	Unit
V_{RSM}	max. non-repetitive reverse blocking voltage					1700	V
V_{RRM}	max. repetitive reverse blocking voltage					1600	V
I_R	reverse current	$V_R = 1600$ V	$T_{VJ} = 25^\circ\text{C}$			100	μA
		$V_R = 1600$ V	$T_{VJ} = 150^\circ\text{C}$			1.5	mA
V_F	forward voltage drop	$I_F = 25$ A	$T_{VJ} = 25^\circ\text{C}$			1.06	V
		$I_F = 75$ A				1.30	V
		$I_F = 25$ A	$T_{VJ} = 125^\circ\text{C}$			0.96	V
		$I_F = 75$ A				1.27	V
I_{DAV}	bridge output current	$T_C = 110^\circ\text{C}$ rectangular	$T_{VJ} = 150^\circ\text{C}$ $d = \frac{1}{3}$			75	A
V_{FO}	threshold voltage	} for power loss calculation only				0.77	V
r_F	slope resistance					6.5	m Ω
R_{thJC}	thermal resistance junction to case					1.2	K/W
R_{thCH}	thermal resistance case to heatsink				0.4		K/W
P_{tot}	total power dissipation			$T_C = 25^\circ\text{C}$		100	W
I_{FSM}	max. forward surge current	$t = 10$ ms; (50 Hz), sine	$T_{VJ} = 45^\circ\text{C}$			700	A
		$t = 8,3$ ms; (60 Hz), sine	$V_R = 0$ V			755	A
		$t = 10$ ms; (50 Hz), sine	$T_{VJ} = 150^\circ\text{C}$			595	A
		$t = 8,3$ ms; (60 Hz), sine	$V_R = 0$ V			645	A
I^2t	value for fusing	$t = 10$ ms; (50 Hz), sine	$T_{VJ} = 45^\circ\text{C}$			2.45	kA ² s
		$t = 8,3$ ms; (60 Hz), sine	$V_R = 0$ V			2.37	kA ² s
		$t = 10$ ms; (50 Hz), sine	$T_{VJ} = 150^\circ\text{C}$			1.77	kA ² s
		$t = 8,3$ ms; (60 Hz), sine	$V_R = 0$ V			1.73	kA ² s
C_J	junction capacitance	$V_R = 400$ V; $f = 1$ MHz		$T_{VJ} = 25^\circ\text{C}$		25	pF

Package FO-F-B		Ratings				
Symbol	Definition	Conditions	min.	typ.	max.	Unit
I_{RMS}	RMS current	per terminal			100	A
T_{stg}	storage temperature		-40		125	°C
T_{VJ}	virtual junction temperature		-40		150	°C
Weight				45		g
M_D	mounting torque		2		2.5	Nm
$d_{Spp/App}$	creepage distance on surface striking distance through air	terminal to terminal	18.0	6.0		mm
$d_{Spb/Apb}$		terminal to backside	26.0	20.0		mm
V_{ISOL}	isolation voltage	t = 1 second				V
		t = 1 minute	50/60 Hz, RMS; $I_{ISOL} \leq 1$ mA			V



Ordering	Part Number	Marking on Product	Delivery Mode	Quantity	Code No.
Standard	VUO60-16NO3	VUO60-16NO3	Box	10	465348

Equivalent Circuits for Simulation

* on die level

$T_{VJ} = 150^\circ\text{C}$

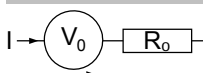

Rectifier

$V_{0\max}$	threshold voltage	0.77	V
$R_{0\max}$	slope resistance *	5.3	mΩ

Outlines FO-F-B

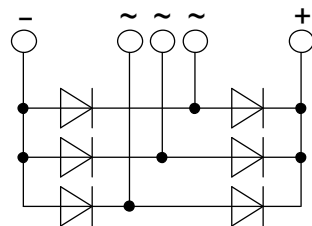
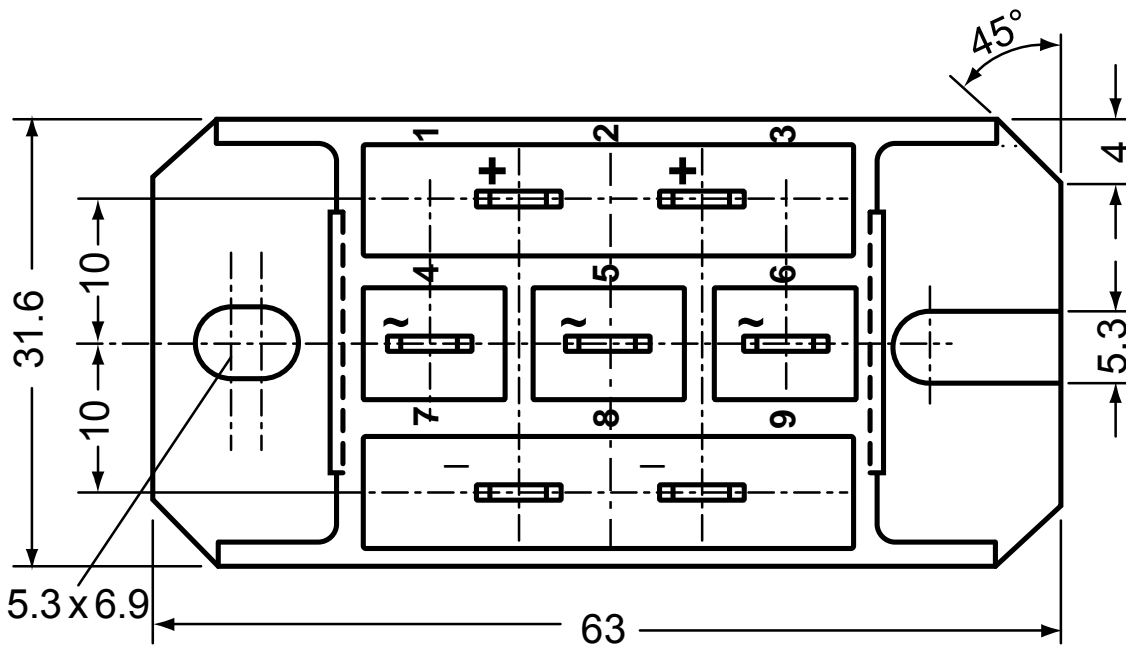
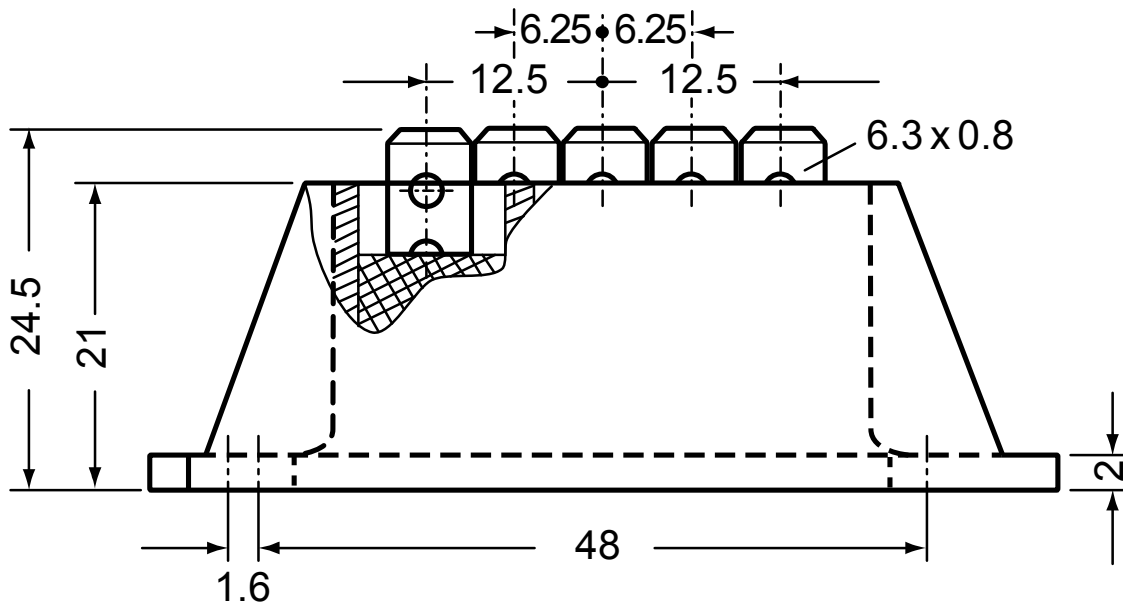

Rectifier

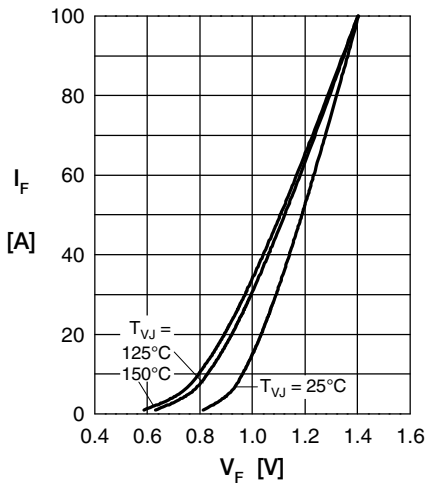

Fig. 1 Forward current vs. voltage drop per diode

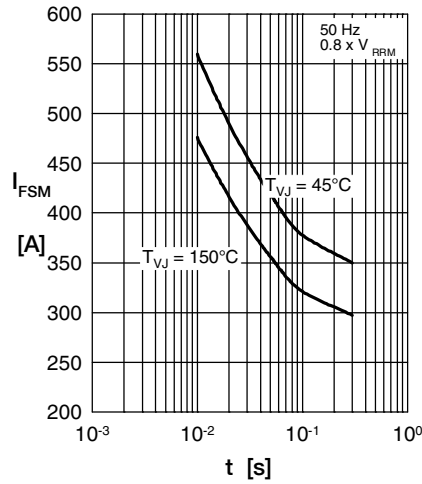

Fig. 2 Surge overload current vs. time per diode

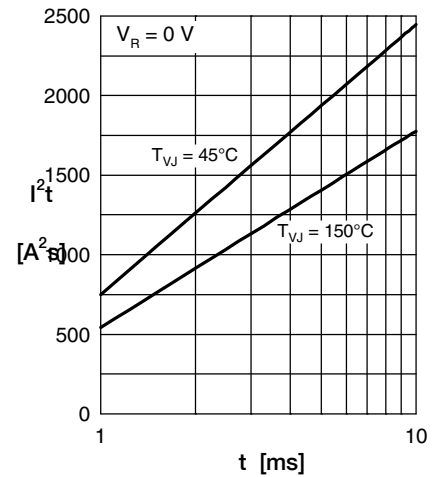

Fig. 3 I^2t vs. time per diode

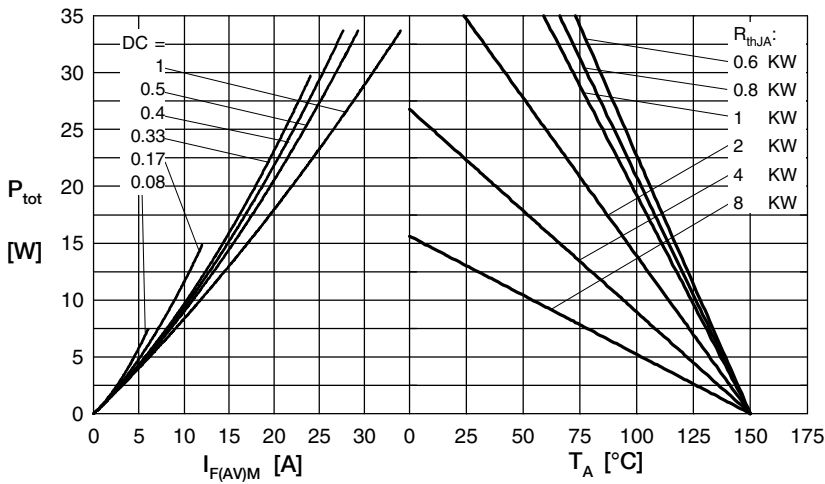

Fig. 4 Power dissipation vs. forward current and ambient temperature per diode

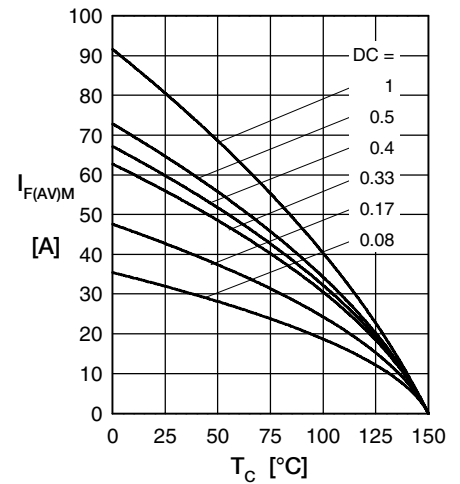

Fig. 5 Max. forward current vs. case temperature per diode

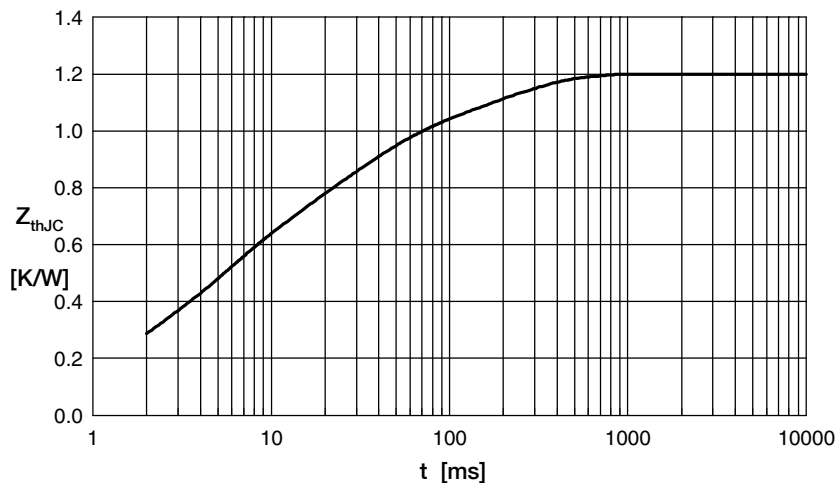

Fig. 6 Transient thermal impedance junction to case vs. time per diode

Constants for Z_{thJC} calculation:

i	R_{th} (K/W)	t_i (s)
1	0.0607	0.00040
2	0.1330	0.00256
3	0.3305	0.00450
4	0.4130	0.02420
5	0.2628	0.18000