

# Standard Rectifier Module

<b>1~ Rectifier</b>
$V_{RRM} = 1200\text{ V}$
$I_{DAV} = 160\text{ A}$
$I_{FSM} = 2800\text{ A}$

## 1~ Rectifier Bridge

Part number

VBO160-12NO7

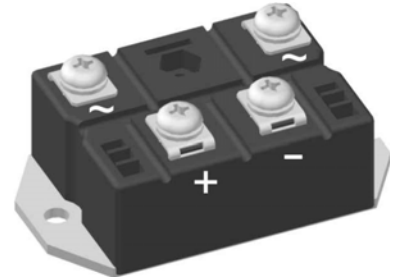

 E72873

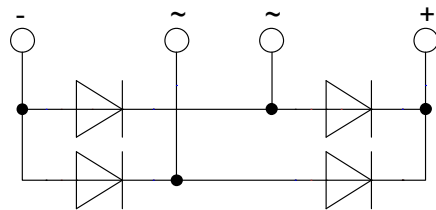

### Features / Advantages:

- Package with DCB ceramic
- Improved temperature and power cycling
- Planar passivated chips
- Very low forward voltage drop
- Very low leakage current

### Applications:

- Diode for main rectification
- For one phase bridge configurations
- Supplies for DC power equipment
- Input rectifiers for PWM inverter
- Battery DC power supplies
- Field supply for DC motors

### Package: PWS-E

- Industry standard outline
- RoHS compliant
- Easy to mount with two screws
- Base plate: Copper internally DCB isolated
- Advanced power cycling

Rectifier				Ratings			
Symbol	Definition	Conditions		min.	typ.	max.	Unit
$V_{RSM}$	max. non-repetitive reverse blocking voltage					1300	V
$V_{RRM}$	max. repetitive reverse blocking voltage					1200	V
$I_R$	reverse current	$V_R = 1200$ V	$T_{VJ} = 25^\circ\text{C}$			200	$\mu\text{A}$
		$V_R = 1200$ V	$T_{VJ} = 150^\circ\text{C}$			3.5	mA
$V_F$	forward voltage drop	$I_F = 160$ A	$T_{VJ} = 25^\circ\text{C}$			1.07	V
		$I_F = 320$ A				1.22	V
		$I_F = 160$ A	$T_{VJ} = 125^\circ\text{C}$			0.96	V
		$I_F = 320$ A				1.15	V
$I_{DAV}$	bridge output current	$T_C = 110^\circ\text{C}$ rectangular	$T_{VJ} = 150^\circ\text{C}$			160	A
$V_{FO}$	threshold voltage	} for power loss calculation only	$T_{VJ} = 150^\circ\text{C}$			0.74	V
$r_F$	slope resistance					2.4	m $\Omega$
$R_{thJC}$	thermal resistance junction to case					0.4	K/W
$R_{thCH}$	thermal resistance case to heatsink				0.15		K/W
$P_{tot}$	total power dissipation			$T_C = 25^\circ\text{C}$		310	W
$I_{FSM}$	max. forward surge current	$t = 10$ ms; (50 Hz), sine	$T_{VJ} = 45^\circ\text{C}$			2.80	kA
		$t = 8,3$ ms; (60 Hz), sine	$V_R = 0$ V			3.03	kA
		$t = 10$ ms; (50 Hz), sine	$T_{VJ} = 150^\circ\text{C}$			2.38	kA
		$t = 8,3$ ms; (60 Hz), sine	$V_R = 0$ V			2.57	kA
$I^2t$	value for fusing	$t = 10$ ms; (50 Hz), sine	$T_{VJ} = 45^\circ\text{C}$			39.2	kA <sup>2</sup> s
		$t = 8,3$ ms; (60 Hz), sine	$V_R = 0$ V			38.1	kA <sup>2</sup> s
		$t = 10$ ms; (50 Hz), sine	$T_{VJ} = 150^\circ\text{C}$			28.3	kA <sup>2</sup> s
		$t = 8,3$ ms; (60 Hz), sine	$V_R = 0$ V			27.5	kA <sup>2</sup> s
$C_J$	junction capacitance	$V_R = 400$ V; $f = 1$ MHz	$T_{VJ} = 25^\circ\text{C}$		133		pF

Package PWS-E			Ratings			
Symbol	Definition	Conditions	min.	typ.	max.	Unit
$I_{RMS}$	RMS current	per terminal			250	A
$T_{stg}$	storage temperature		-40		125	°C
$T_{VJ}$	virtual junction temperature		-40		150	°C
<b>Weight</b>				273		g
$M_D$	mounting torque		4.25		5.75	Nm
$M_T$	terminal torque		4.25		5.75	Nm
$d_{Spp/App}$	creepage distance on surface   striking distance through air	terminal to terminal	12.0			mm
$d_{Spb/Appb}$		terminal to backside	26.0			mm
$V_{ISOL}$	isolation voltage	t = 1 second	3000			V
		t = 1 minute	2500			V

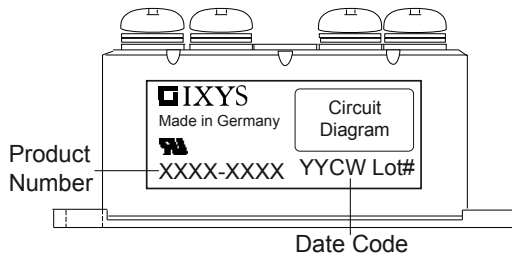

Ordering	Part Number	Marking on Product	Delivery Mode	Quantity	Code No.
Standard	VBO160-12NO7	VBO160-12NO7	Box	5	474029

### Equivalent Circuits for Simulation

\* on die level

$T_{VJ} = 150\text{ °C}$



Rectifier

$V_{0\text{ max}}$	threshold voltage	0.74	V
$R_{0\text{ max}}$	slope resistance *	1.2	mΩ

Outlines PWS-E

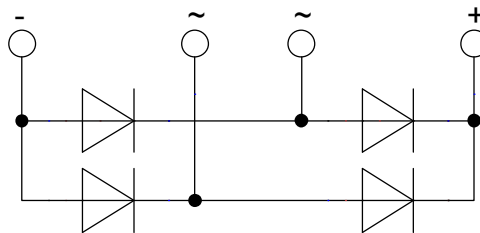
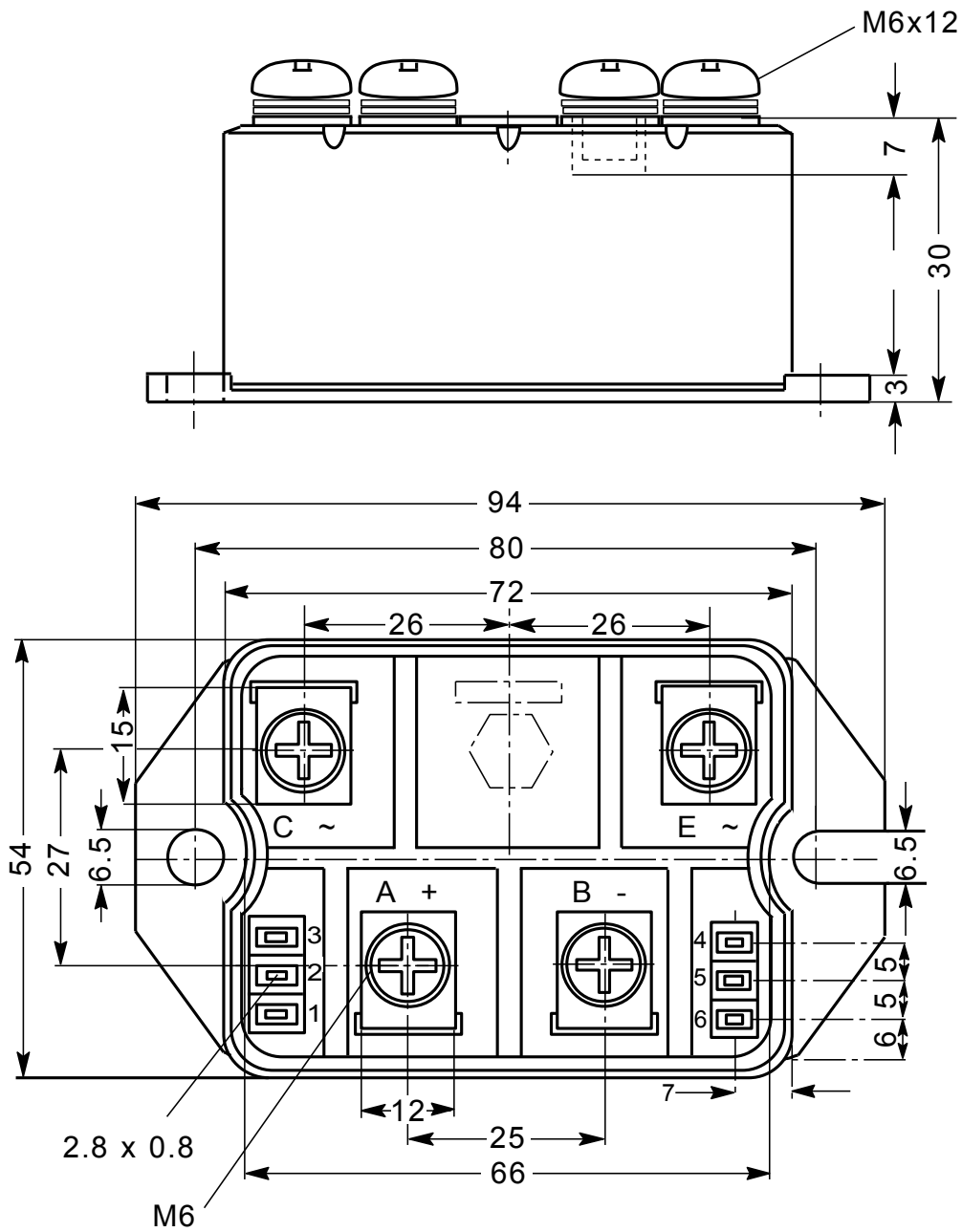

**Rectifier**

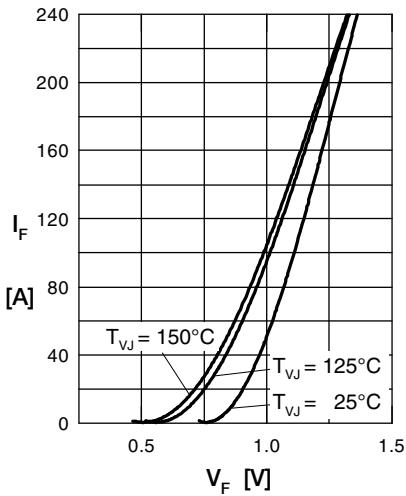

Fig. 1 Forward current vs. voltage drop per diode

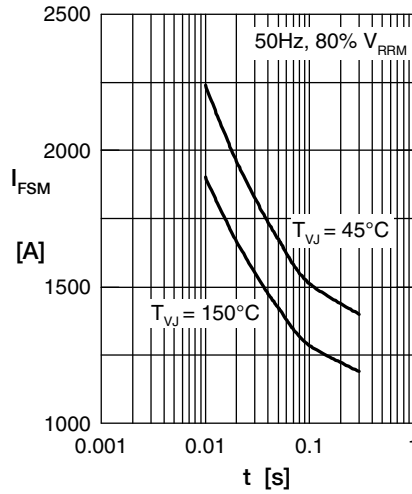

Fig. 2 Surge overload current vs. time per diode

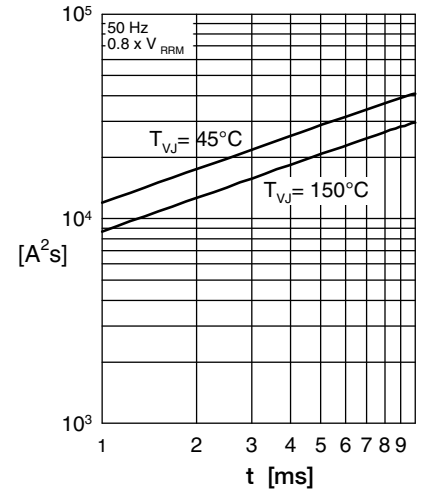

Fig. 3  $I^2t$  vs. time per diode

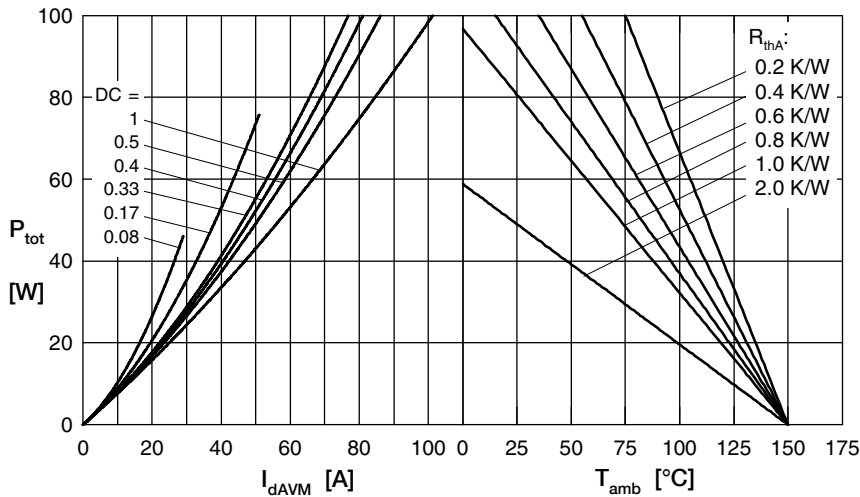

Fig. 4 Power dissipation vs. forward current and ambient temperature per diode

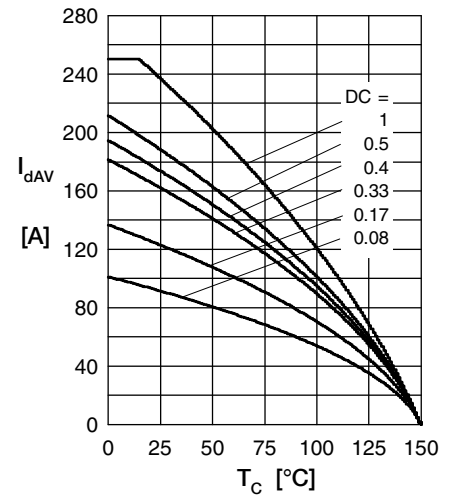

Fig. 5 Max. forward current vs. case temperature per diode

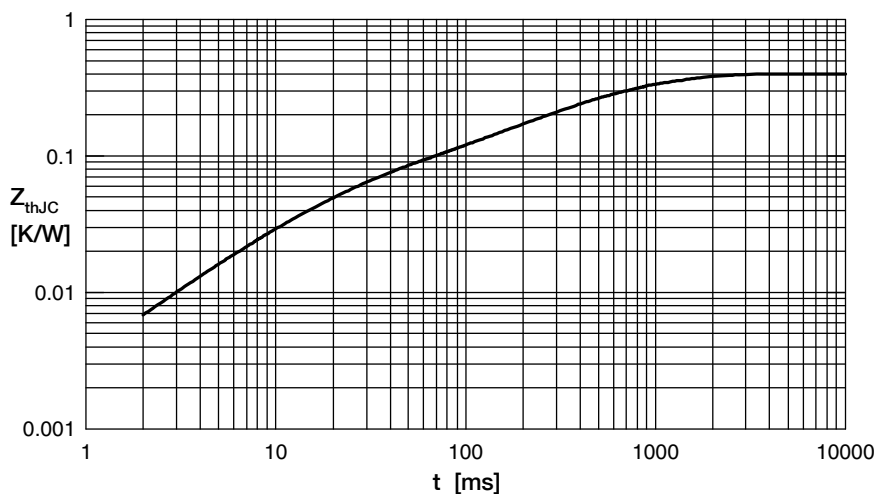

Fig. 6 Transient thermal impedance junction to case vs. time per diode

$R_i$	$t_i$
0.050	0.02
0.003	0.01
0.100	0.225
0.177	0.8
0.070	0.58