

# Single Phase Rectifier Bridge with Fast Recovery Epitaxial Diodes (FRED) in ECO-PAC 2

$I_{dAV} = 100 \text{ A}$   
 $V_{RRM} = 600 \text{ V}$   
 $t_{rr} = 35 \text{ ns}$

Preliminary data sheet

$V_{RSM}$ V	$V_{RRM}$ V	Typ
600	600	VBE 100-06NO7

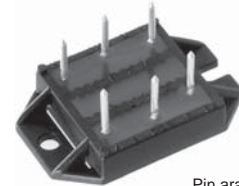
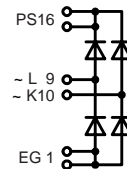

Pin arrangement see outlines

Symbol	Conditions	Maximum Ratings	
$I_{dAV}^{①}$	$T_C = 85^\circ\text{C}$ , module	100	A
$I_{dAVM}$		100	A
$I_{FSM}$	$T_{VJ} = 45^\circ\text{C}$ $V_R = 0$	$t = 10 \text{ ms}$ (50 Hz), sine	600 A
		$t = 8.3 \text{ ms}$ (60 Hz), sine	640 A
	$T_{VJ} = T_{VJM}$ $V_R = 0$	$t = 10 \text{ ms}$ (50 Hz), sine	520 A
		$t = 8.3 \text{ ms}$ (60 Hz), sine	555 A
$I^2t$	$T_{VJ} = 45^\circ\text{C}$ $V_R = 0$	$t = 10 \text{ ms}$ (50 Hz), sine	1800 A <sup>2</sup> s
		$t = 8.3 \text{ ms}$ (60 Hz), sine	1720 A <sup>2</sup> s
	$T_{VJ} = T_{VJM}$ $V_R = 0$	$t = 10 \text{ ms}$ (50 Hz), sine	1350 A <sup>2</sup> s
		$t = 8.3 \text{ ms}$ (60 Hz), sine	1295 A <sup>2</sup> s
$T_{VJ}$		-40...+150	°C
$T_{VJM}$		150	°C
$T_{stg}$		-40...+125	°C
$V_{ISOL}$	50/60 Hz, RMS	$t = 1 \text{ min}$	3000 V~
	$I_{ISOL} \leq 1 \text{ mA}$	$t = 1 \text{ s}$	3600 V~
$M_d$ Weight	Mounting torque (M4)	1.5-2/14-18	Nm/lb.in.
	typ.	24	g

## Features

- Package with DCB ceramic base plate in low profile
- Isolation voltage 3000 V~
- Planar passivated chips
- Low forward voltage drop
- Leads suitable for PC board soldering

## Applications

- Supplies for DC power equipment
- Input and output rectifiers for high frequency
- Battery DC power supplies
- Field supply for DC motors

## Advantages

- Space and weight savings
- Improved temperature and power cycling capability
- Small and light weight
- Low noise switching

Symbol	Conditions	Characteristic Values	
		typ.	max.
$I_R$	$V_R = V_{RRM}$ $T_{VJ} = 25^\circ\text{C}$		0.1 mA
	$V_R = V_{RRM}$ $T_{VJ} = T_{VJM}$		2.5 mA
$V_F$	$I_F = 60 \text{ A}$ $T_{VJ} = 25^\circ\text{C}$		2.04 V
$V_{T0}$	for power-loss calculations only		1.09 V
$r_T$			4.3 mΩ
$R_{thJC}$	per diode; DC current		0.8 K/W
$R_{thCH}$	per diode; DC current, typ.		0.2 K/W
$I_{RM}$	$I_F = 130 \text{ A}$ , $-di/dt = 100 \text{ A}/\mu\text{s}$ $V_R = 100 \text{ V}$ , $T_{VJ} = 100^\circ\text{C}$		6.8 A
$t_{rr}$	$I_F = 1 \text{ A}$ ; $-di/dt = 300 \text{ A}/\mu\text{s}$ ; $V_R = 30 \text{ V}$ , $T_{VJ} = 25^\circ\text{C}$	35	ns
$a$	Max. allowable acceleration	50	m/s <sup>2</sup>
$d_s$	creeping distance on surface (pin to heatsink)	11.2	mm
$d_A$	strike distance in air (pin to heatsink)	9.7	mm

Data according to IEC 60747 refer to a single diode unless otherwise stated

① for resistive load at bridge output.

IXYS reserves the right to change limits, test conditions and dimensions.

## Dimensions in mm (1 mm = 0.0394")

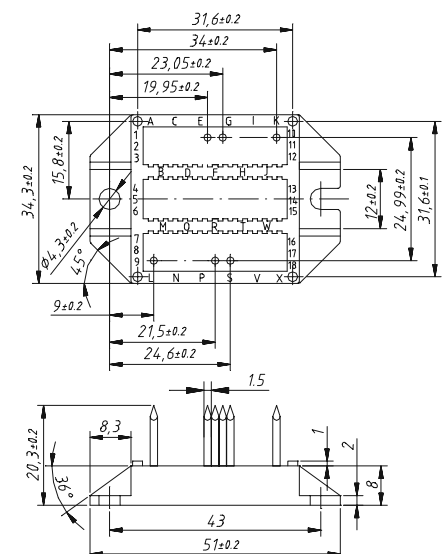

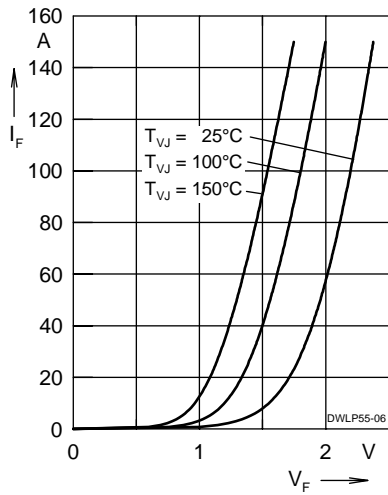

Fig. 1 Forward current  $I_F$  versus  $V_F$

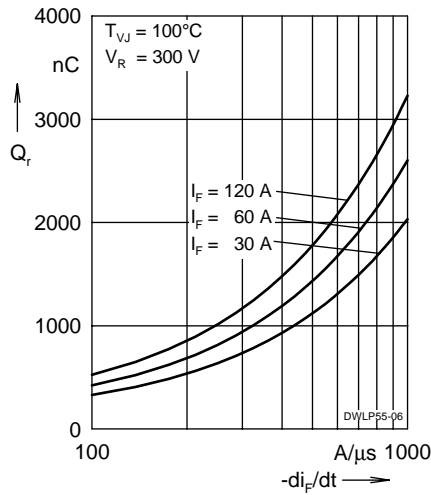

Fig. 2 Reverse recovery charge  $Q_r$  versus  $-di_F/dt$

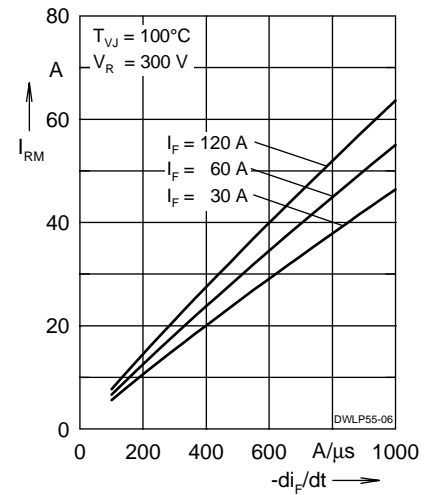

Fig. 3 Peak reverse current  $I_{RM}$  versus  $-di_F/dt$

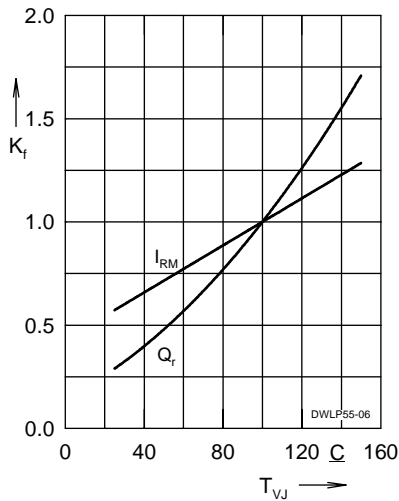

Fig. 4 Dynamic parameters  $Q_r$ ,  $I_{RM}$  versus  $T_{VJ}$

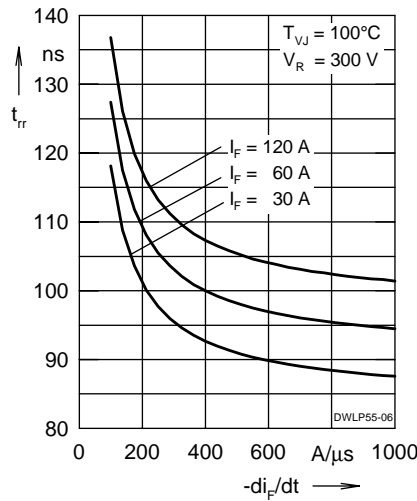

Fig. 5 Recovery time  $t_{rr}$  versus  $-di_F/dt$

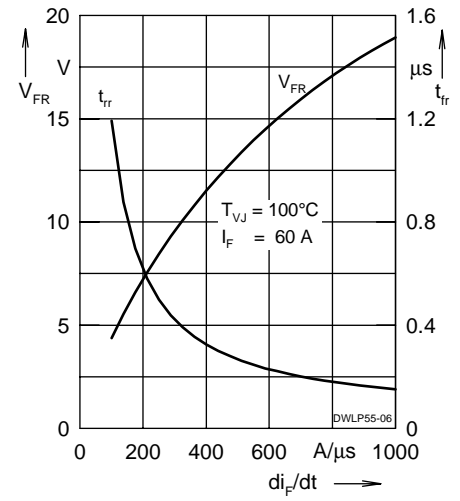

Fig. 6 Peak forward voltage  $V_{FR}$  and  $t_{rr}$  versus  $di_F/dt$

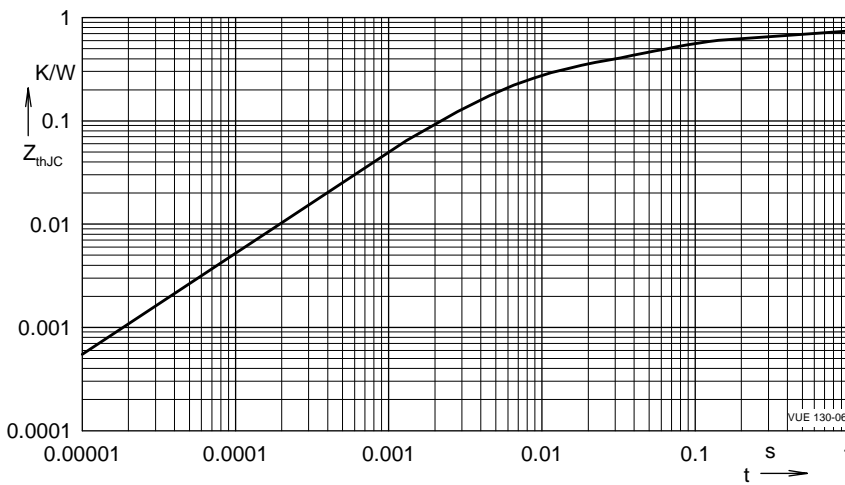

Fig. 7 Typical transient thermal resistance junction to case

NOTE: Fig. 2 to Fig. 6 shows typical values

IXYS reserves the right to change limits, test conditions and dimensions.