

N-Channel Enhancement Mode Field Effect Transistor

PDFN5060-8L

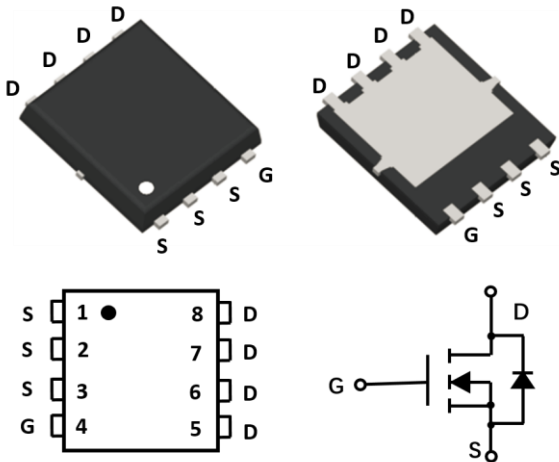

Product Summary

- V_{DS} 60V
- I_D 110A
- I_D (Package limited) 80A
- $R_{DS(ON)}$ (at $V_{GS}=10V$) <4 mohm
- $R_{DS(ON)}$ (at $V_{GS}=4.5V$) <5 mohm
- 100% UIS Tested
- 100% ∇V_{DS} Tested

General Description

- Split Gate Trench MOSFET technology
- Excellent package for heat dissipation
- High density cell design for low $R_{DS(ON)}$

Applications

- DC-DC Converters
- Power management functions
- Industrial and Motor Drive application

■ Absolute Maximum Ratings ($T_A=25^\circ\text{C}$ unless otherwise noted)

Parameter	Symbol	Limit	Unit
Drain-source Voltage	V_{DS}	60	V
Gate-source Voltage	V_{GS}	± 20	V
Drain Current	I_D	110	A
Drain Current ^A	I_D	$T_C=25^\circ\text{C}$	80
		$T_C=100^\circ\text{C}$	50
Pulsed Drain Current ^B	I_{DM}	320	A
Avalanche energy ^C	E_{AS}	250	mJ
Total Power Dissipation	P_D	$T_C=25^\circ\text{C}$	95
		$T_C=100^\circ\text{C}$	38
Thermal Resistance Junction-to-Case	$R_{\theta JC}$	1.47	$^\circ\text{C}/\text{W}$
Junction and Storage Temperature Range	T_J, T_{STG}	-55~+150	$^\circ\text{C}$

■ Ordering Information (Example)

PREFERRED P/N	PACKING CODE	Marking	MINIMUM PACKAGE(pcs)	INNER BOX QUANTITY(pcs)	OUTER CARTON QUANTITY(pcs)	DELIVERY MODE
YJG80G06A	F2	YJG80G06A	3000	6000	60000	13" reel



YJG80G06A

■ Electrical Characteristics (T_J=25°C unless otherwise noted)

Parameter	Symbol	Conditions	Min	Typ	Max	Units
Static Parameter						
Drain-Source Breakdown Voltage	BV _{DSS}	V _{GS} = 0V, I _D =250μA	60			V
Zero Gate Voltage Drain Current	I _{DSS}	V _{DS} =60V, V _{GS} =0V	T _J =25°C		1	μA
			T _J =55°C		5	
Gate-Body Leakage Current	I _{GSS}	V _{GS} = ±20V, V _{DS} =0V			±100	nA
Gate Threshold Voltage	V _{GS(th)}	V _{DS} = V _{GS} , I _D =250μA	1.2	1.7	2.2	V
Static Drain-Source On-Resistance	R _{DS(on)}	V _{GS} = 10V, I _D =20A		3.5	4.2	mΩ
		V _{GS} = 4.5V, I _D =10A		4.2	5.2	
Diode Forward Voltage	V _{SD}	I _S =40A, V _{GS} =0V		0.8	1.2	V
Maximum Body-Diode Continuous Current	I _S				80	A
Dynamic Parameters						
Input Capacitance	C _{iss}	V _{DS} =30V, V _{GS} =0V, f=1MHZ		3980		pF
Output Capacitance	C _{oss}			690		
Reverse Transfer Capacitance	C _{rss}			24		
Switching Parameters						
Total Gate Charge	Q _g	V _{GS} =10V, V _{DS} =30V, I _D =20A		67		nC
Gate-Source Charge	Q _{gs}			12		
Gate-Drain Charge	Q _{gd}			8.5		
Reverse Recovery Charge	Q _{rr}	I _F =20A, di/dt=500A/us		48		ns
Reverse Recovery Time	t _{rr}			60		
Turn-on Delay Time	t _{D(on)}	V _{GS} =10V, V _{DD} =30V, R _L =2.5Ω R _{GEN} =3Ω		15		ns
Turn-on Rise Time	t _r			8		
Turn-off Delay Time	t _{D(off)}			48		
Turn-off fall Time	t _f			13		

- A. The maximum current rating is package limited.
 B. Pulse Test: Pulse Width ≤ 300us, Duty cycle ≤ 2%.
 C. T_J=25°C, V_{DD}=30V, V_G=10V, L=0.5mH, R_g=25 Ω



■ Typical Performance Characteristics

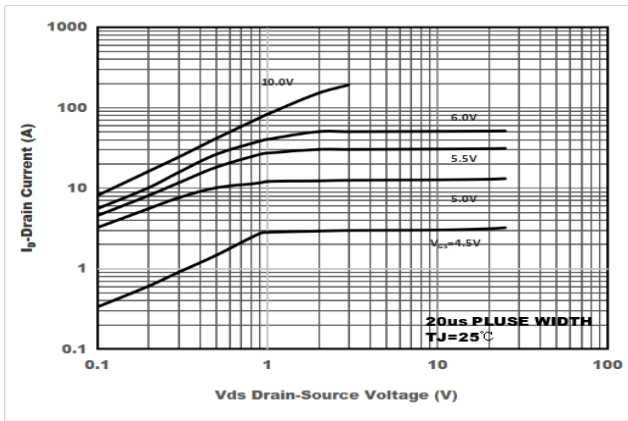

Figure1. Output Characteristics

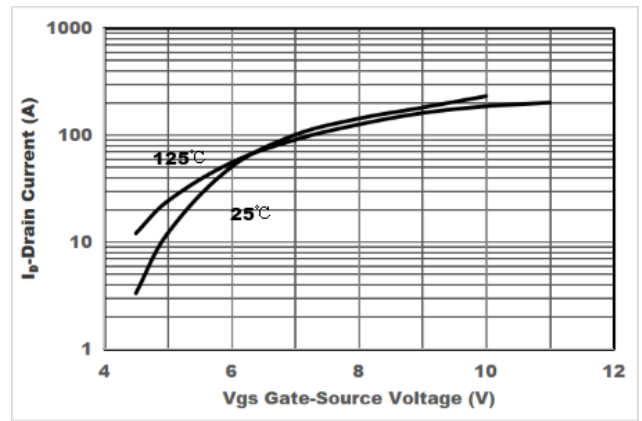

Figure2. Transfer Characteristics

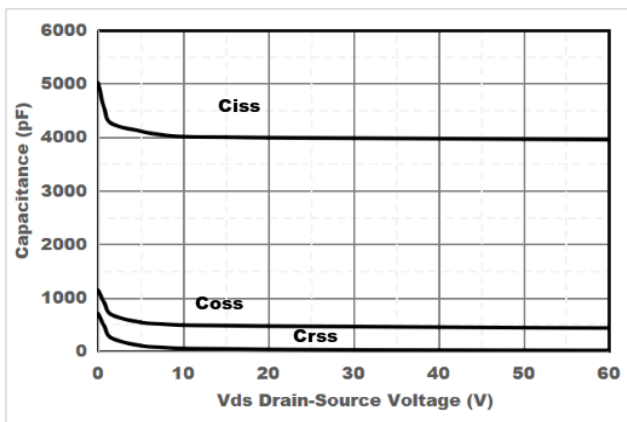

Figure3. Capacitance Characteristics

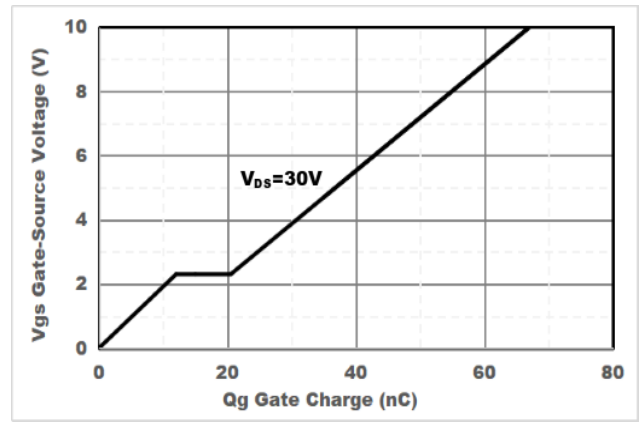

Figure4. Gate Charge

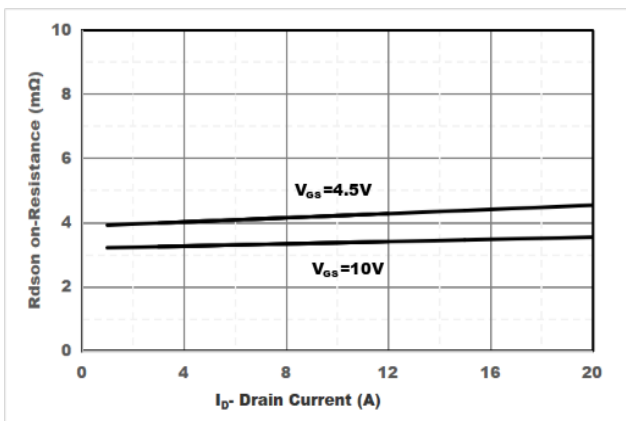

Figure5. Drain-Source on Resistance

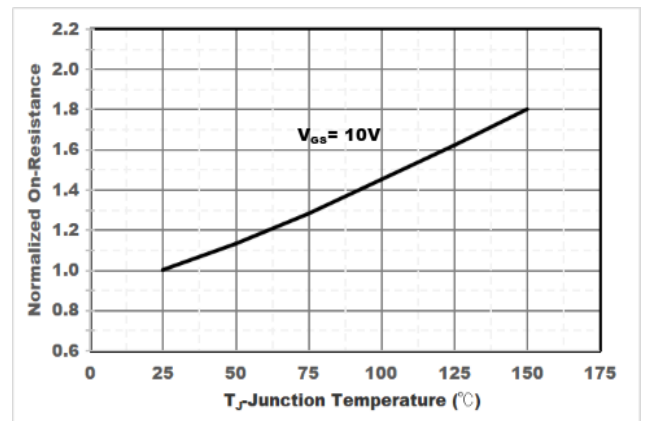

Figure6. Drain-Source on Resistance

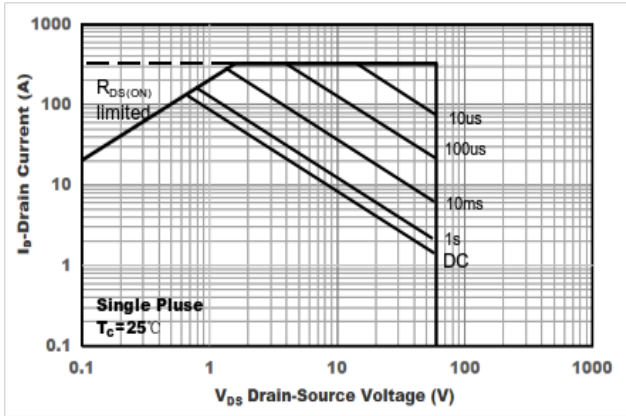

Figure7. Safe Operation Area

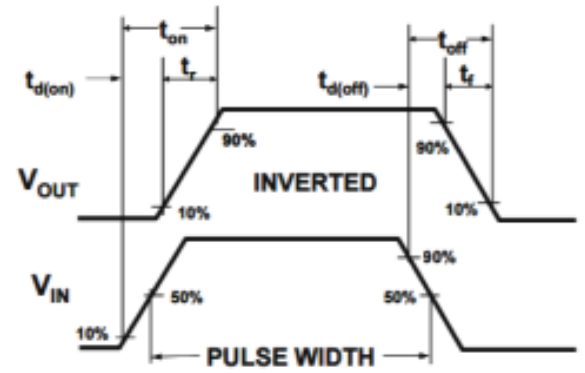
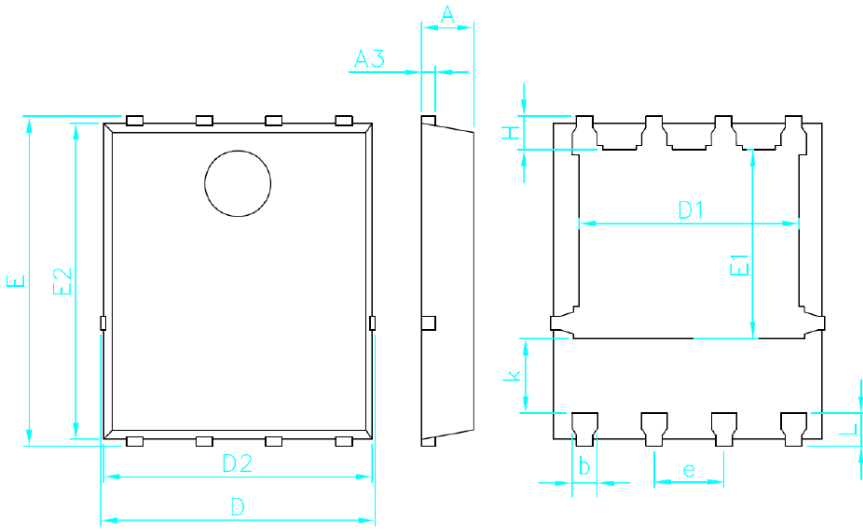

Figure8. Switching wave



YJG80G06A

■ PDFN5060-8L Package information



Symbol	Min	Typ.	Max
A	0.900	0.950	1.000
A3	0.254REF.		
D	4.900	5.000	5.100
E	5.900	6.000	6.100
D1	3.750	3.950	4.150
E1	3.300	3.450	3.600
D2	4.800	4.900	5.000
E2	5.650	5.750	5.850
k	1.200	1.350	1.500
b	0.350	0.400	0.450
e	1.220	1.270	1.320
L	0.510	0.610	0.710
H	0.510	0.610	0.710



YJG80G06A

Disclaimer

The information presented in this document is for reference only. Yangzhou Yangjie Electronic Technology Co., Ltd. reserves the right to make changes without notice for the specification of the products displayed herein to improve reliability, function or design or otherwise.

The product listed herein is designed to be used with ordinary electronic equipment or devices, and not designed to be used with equipment or devices which require high level of reliability and the malfunction of which would directly endanger human life (such as medical instruments, transportation equipment, aerospace machinery, nuclear-reactor controllers, fuel controllers and other safety devices), Yangjie or anyone on its behalf, assumes no responsibility or liability for any damages resulting from such improper use of sale.

This publication supersedes & replaces all information previously supplied. For additional information, please visit our website [http:// www.21yangjie.com](http://www.21yangjie.com) , or consult your nearest Yangjie's sales office for further assistance.