

## N-Channel Enhancement Mode Field Effect Transistor

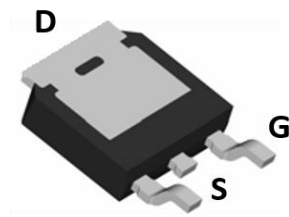

**TO-252**

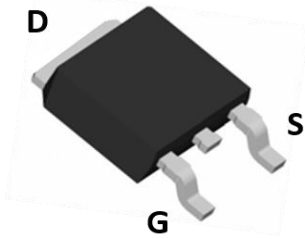
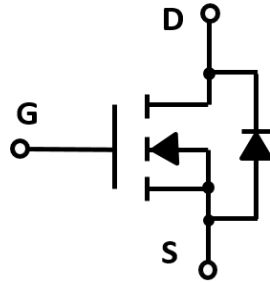

### Product Summary

- $V_{DS}$  100V
- $I_D$  15A
- $R_{DS(ON)}$  (at  $V_{GS}=10V$ ) < 110 mohm
- $R_{DS(ON)}$  (at  $V_{GS}=4.5V$ ) < 120 mohm
- 100% UIS Tested
- 100%  $\nabla V_{DS}$  Tested

### General Description

- Trench Power MV MOSFET technology
- Excellent package for heat dissipation
- High density cell design for low  $R_{DS(ON)}$

### Applications

- DC-DC Converters
- Power management functions

### ■ Absolute Maximum Ratings ( $T_A=25^\circ\text{C}$ unless otherwise noted)

Parameter	Symbol	Limit	Unit
Drain-source Voltage	$V_{DS}$	100	V
Gate-source Voltage	$V_{GS}$	$\pm 20$	V
Drain Current	$I_D$	$T_C=25^\circ\text{C}$	15
		$T_C=100^\circ\text{C}$	10.5
Pulsed Drain Current <sup>A</sup>	$I_{DM}$	60	A
Single Pulse Avalanche Energy	$E_{AS}$	9	mJ
Total Power Dissipation	$P_D$	$T_C=25^\circ\text{C}$	45
		$T_C=100^\circ\text{C}$	22.5
Thermal Resistance Junction-to-Case <sup>B</sup>	$R_{\theta JC}$	3.3	$^\circ\text{C}/\text{W}$
Junction and Storage Temperature Range	$T_J, T_{STG}$	-55~+175	$^\circ\text{C}$

### ■ Ordering Information (Example)

PREFERRED P/N	PACKING CODE	Marking	MINIMUM PACKAGE(pcs)	INNER BOX QUANTITY(pcs)	OUTER CARTON QUANTITY(pcs)	DELIVERY MODE
YJD15N10A	F1	YJD15N10A	2500	2500	25000	13" reel



# YJD15N10A

## ■ Electrical Characteristics ( $T_A=25^\circ\text{C}$ unless otherwise noted)

Parameter	Symbol	Conditions	Min	Typ	Max	Units
<b>Static Parameter</b>						
Drain-Source Breakdown Voltage	$BV_{DSS}$	$V_{GS}=0V, I_D=250\mu A$	100			V
Zero Gate Voltage Drain Current	$I_{DSS}$	$V_{DS}=100V, V_{GS}=0V$	$T_J=25^\circ\text{C}$		1	$\mu A$
			$T_J=55^\circ\text{C}$		5	
Gate-Body Leakage Current	$I_{GSS}$	$V_{GS}=\pm 20V, V_{DS}=0V$			$\pm 100$	nA
Gate Threshold Voltage	$V_{GS(th)}$	$V_{DS}=V_{GS}, I_D=250\mu A$	1	1.8	3.0	V
Static Drain-Source On-Resistance	$R_{DS(on)}$	$V_{GS}=10V, I_D=12A$		95	110	m $\Omega$
		$V_{GS}=4.5V, I_D=8A$		100	120	
Diode Forward Voltage	$V_{SD}$	$I_S=15A, V_{GS}=0V$		0.8	1.2	V
Maximum Body-Diode Continuous Current	$I_S$				15	A
<b>Dynamic Parameters</b>						
Input Capacitance	$C_{iss}$	$V_{DS}=50V, V_{GS}=0V, f=1\text{MHZ}$		785		pF
Output Capacitance	$C_{oss}$			38		
Reverse Transfer Capacitance	$C_{rss}$			30		
<b>Switching Parameters</b>						
Total Gate Charge	$Q_g$	$V_{GS}=10V, V_{DS}=50V, I_D=10A$		16		nC
Gate-Source Charge	$Q_{gs}$			2.5		
Gate-Drain Charge	$Q_{gd}$			2.6		
Turn-on Delay Time	$t_{D(on)}$	$V_{GS}=10V, V_{DD}=50V, R_L=6.4\Omega$ $R_{GEN}=3\Omega$		5		ns
Turn-on Rise Time	$t_r$			40		
Turn-off Delay Time	$t_{D(off)}$			20		
Turn-off fall Time	$t_f$			7		

A. Pulse Test: Pulse Width  $\leq 300\mu s$ , Duty cycle  $\leq 2\%$ .

B.  $R_{\theta JA}$  is the sum of the junction-to-case and case-to-ambient thermal resistance, where the case thermal reference is defined as the solder mounting surface of the drain pins.  $R_{\theta JC}$  is guaranteed by design, while  $R_{\theta JA}$  is determined by the board design. The maximum rating presented here is based on mounting on a 1 in 2 pad of 2oz copper.



## ■ Typical Performance Characteristics

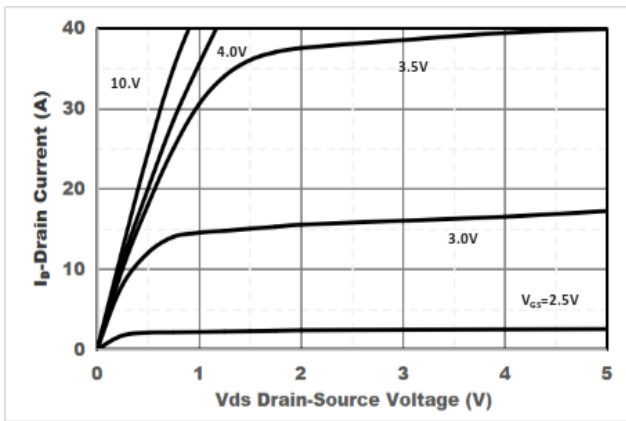

Figure1. Output Characteristics

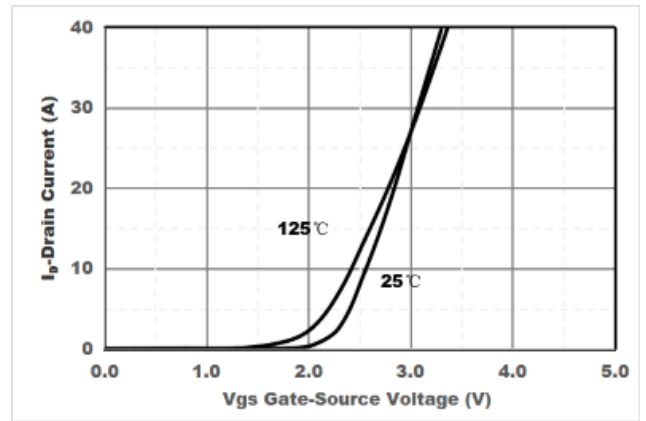

Figure2. Transfer Characteristics

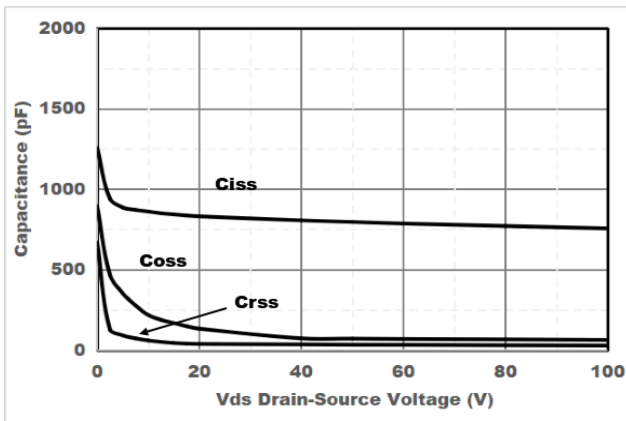

Figure3. Capacitance Characteristics

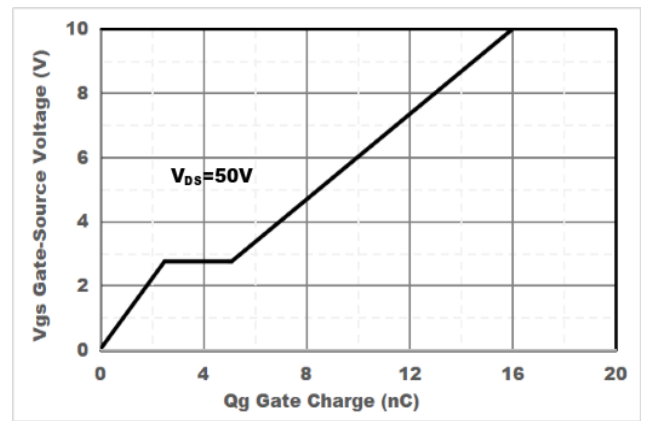

Figure4. Gate Charge

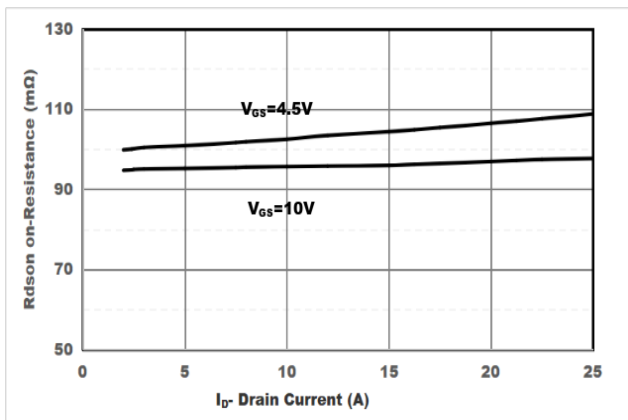

Figure5. Drain-Source on Resistance

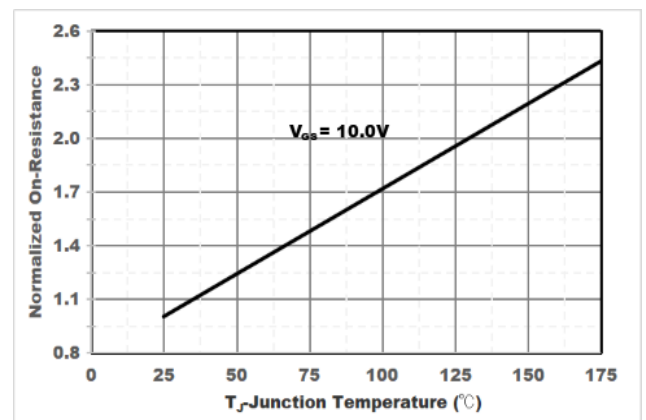

Figure6. Drain-Source on Resistance



# YJD15N10A

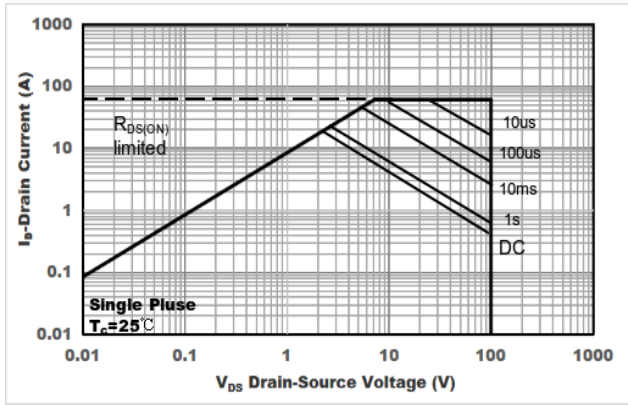

Figure7. Safe Operation Area

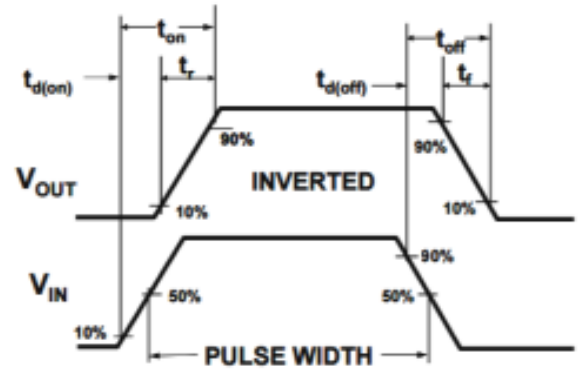
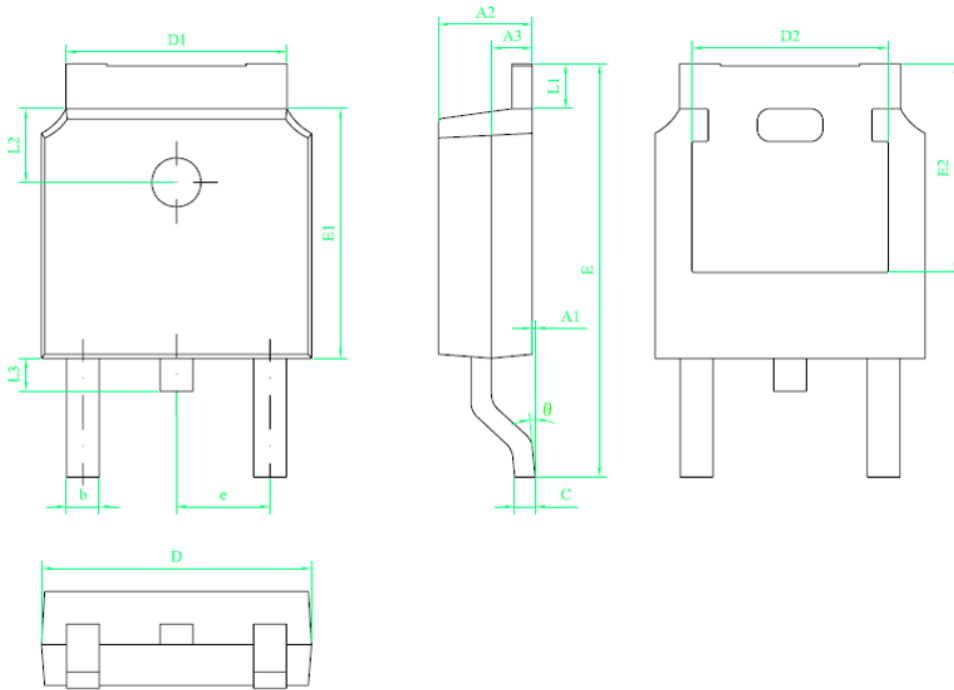

Figure8. Switching wave



# YJD15N10A

## ■ TO-252 Package information



符号	尺寸		
	min	nom	max
A1	0	----	0.10
A2	2.20	2.30	2.40
A3	0.90	1.00	1.10
b	0.75	----	0.85
c	0.50	----	0.60
D	6.50	6.60	6.70
D1	5.30	5.40	5.50
D2	4.70	4.80	4.90
E	9.90	10.10	10.30
E1	6.00	6.10	6.20
E2	5.20	5.30	5.40
e	2.20	2.286	2.40
L1	0.90	----	1.25
L2	1.70	1.80	1.90
L3	0.60	0.80	1.00
θ	0°	----	8°

### 技术要求:

1. 树脂体不应有崩裂、缺损等缺陷;
2. 树脂上下部X、Y方向偏差不得超过0.20;
3. 胶体两端留胶总宽和宽度不得超过0.50;
4. 所有单位为mm;



# YJD15N10A

---

## Disclaimer

The information presented in this document is for reference only. Yangzhou Yangjie Electronic Technology Co., Ltd. reserves the right to make changes without notice for the specification of the products displayed herein to improve reliability, function or design or otherwise.

The product listed herein is designed to be used with ordinary electronic equipment or devices, and not designed to be used with equipment or devices which require high level of reliability and the malfunction of which would directly endanger human life (such as medical instruments, transportation equipment, aerospace machinery, nuclear-reactor controllers, fuel controllers and other safety devices), Yangjie or anyone on its behalf, assumes no responsibility or liability for any damages resulting from such improper use of sale.

This publication supersedes & replaces all information previously supplied. For additional information, please visit our website [http:// www.21yangjie.com](http://www.21yangjie.com) , or consult your nearest Yangjie's sales office for further assistance.