

SG40T120DB

Discrete IGBTs

$$V_{CES} = 1200V$$

$$I_{C100} = 40A$$

$$V_{CE(sat)} \leq 2.9V$$

$$t_{fi(typ)} = 60ns$$

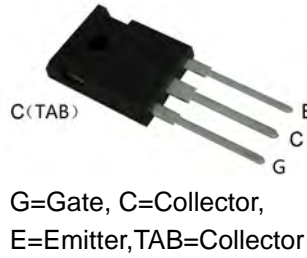

Dimensions TO-247AD

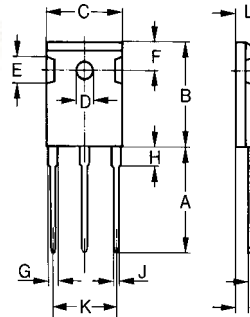

Dim.	Millimeter		Inches	
	Min.	Max.	Min.	Max.
A	19.81	20.32	0.780	0.800
B	20.80	21.46	0.819	0.845
C	15.75	16.26	0.610	0.640
D	3.55	3.65	0.140	0.144
E	4.32	5.49	0.170	0.216
F	5.4	6.2	0.212	0.244
G	1.65	2.13	0.065	0.084
H	-	4.5	-	0.177
J	1.0	1.4	0.040	0.055
K	10.8	11.0	0.426	0.433
L	4.7	5.3	0.185	0.209
M	0.4	0.8	0.016	0.031
N	1.5	2.49	0.087	0.102

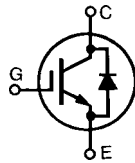

SG40T120DB

IGBT

Symbol	Test Conditions	Maximum Ratings	Unit
V_{CES} V_{CGR}	$T_J=25^{\circ}C$ to $150^{\circ}C$ $T_J=25^{\circ}C$ to $150^{\circ}C$; $R_{GE}=1 M\Omega$;	1200 1200	V
V_{GES} V_{GEM}	Continuous Transient	± 20 ± 30	V
I_{C25} I_{C100} I_{CM}	$T_C=25^{\circ}C$; limited by leads $T_C=100^{\circ}C$ $T_C=25^{\circ}C$, 1 ms	60 40 180	A
SSOA (RBSOA)	$V_{GE}=15V$; $T_{VJ}=125^{\circ}C$; $R_G=5 \Omega$ Clamped inductive load	$I_{CM}=120$ @ 0.8 V_{CES}	A
P_c	$T_C=25^{\circ}C$	300	W
T_J T_{JM} T_{stg}		-55...+150 150 -55...+150	$^{\circ}C$
	Maximum lead temperature for soldering 1.6 mm (0.062 in.) from case for 10s Maximum Tab temperature for soldering SMD devices for 10s	300 260	$^{\circ}C$
M_d	Mounting torque (M3)	1.13/10	Nm/lb.in.
Weight	Typical	6	g

($T_J=25^{\circ}C$, unless otherwise specified)

Symbol	Test Conditions	Characteristic Values			Unit
		min.	typ.	max.	
BV_{CES}	$I_C=1mA$; $V_{GE}=0V$	1200			V
$V_{GE(th)}$	$I_C=750\mu A$; $V_{CE}=V_{GE}$	5.0	5.8	6.5	V
I_{CES}	$V_{CE}=V_{CES}$; $T_J=25^{\circ}C$ $V_{GE}=0V$; $T_J=125^{\circ}C$			250 4	μA mA
I_{GES}	$V_{CE}=0V$; $V_{GE}=\pm 20V$			± 200	nA
$V_{CE(sat)}$	$I_C=I_{C90}$; $V_{GE}=15V$		2.7	2.9	V



SG40T120DB

Discrete IGBTs

(T_J=25°C, unless otherwise specified)

Symbol	Test Conditions	Characteristic Values			Unit
		min.	typ.	max.	
g _{ts}	I _C =I _{C90} ; V _{CE} =10V Pulse test, t _≤ 300us, duty cycle _≤ 2%	33	44		S
I _{C(ON)}	V _{GE} =10V; V _{CE} =10V		220		A
C _{ies} C _{oes} C _{res}	V _{CE} =25V; V _{GE} =0V; f=1MHz		8000 200 120		pF
Q _g Q _{ge} Q _{gc}	I _C =I _{C90} ; V _{GE} =15V; V _{CE} =0.5V _{CES}		170 28 57		nC
t _{d(on)} t _{ri} t _{d(off)} t _{fi} E _{off}	Inductive load, T _J =25°C I _C =I _{C90} ; V _{GE} =15V; V _{CE} =0.8V _{CES} ; R _G =R _{off} =5Ω Remarks:Switching times may increase for V _{CE} (Clamp) > 0.8V _{CES} higher T _J or increased R _G		80 82 340 60 2	400 90 2.5	ns ns ns ns mJ
t _{d(on)} t _{ri} E _{on} t _{d(off)} t _{fi} E _{off}	Inductive load, T _J =125°C I _C =I _{C90} ; V _{GE} =15V; V _{CE} =0.8V _{CES} ; R _G =R _{off} =5Ω Remarks:Switching times may increase for V _{CE} (Clamp) > 0.8V _{CES} higher T _J or increased R _G		68 75 2.5 400 160 2.5	2.9 2.9	ns ns mJ ns ns mJ
R _{thJC}				0.42	K/W
R _{thCK}			0.25		K/W

Reverse Diode (FRED)

(T_J=25°C, unless otherwise specified)

Symbol	Test Conditions	Characteristic Values			Unit
		min.	typ.	max.	
V _F	I _F =40A; T _{VJ} =150°C T _{VJ} =25°C		2.9 3.3		V
I _{RM}	V _R =100V; I _F =40A; -di _F /dt=100A/us L _≤ 0.05uH; T _{VJ} =100°C		12		A
t _{rr}	I _F =1A; -di _F /dt=50A/us; V _R =30V; T _J =25°C		40		ns
R _{thJC}	Diode		1.1	1.2	K/W



SG40T120DB

Discrete IGBTs

Features

- Trench Field Stop IGBT technology
- Low switching losses
- Switching frequency up to 30 kHz
- Square RBSOA, no latch up
- High short circuit capability
- Positive temperature coefficient for easy paralleling
- MOS input, voltage controlled
- Ultra fast free wheeling diodes

Application

- AC and DC motor control
- AC servo and robot drives
- power supplies
- welding inverters

Advantages

- space and weight savings
- reduced protection circuits

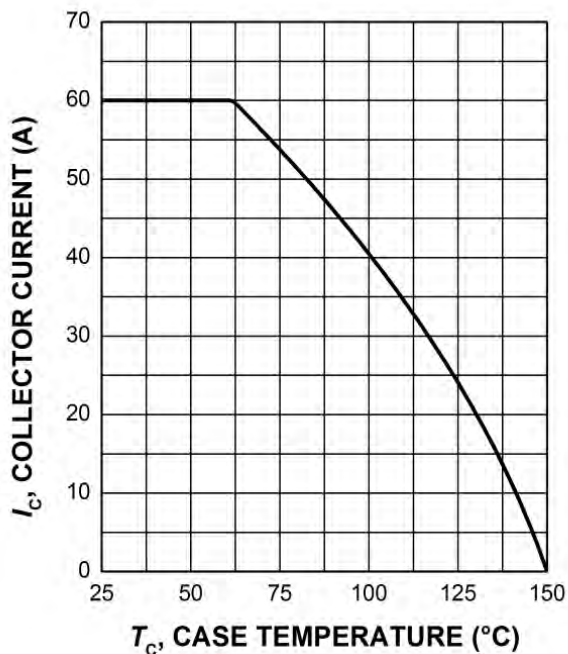

Figure 1. Maximum collector current as a function of case temperature ($V_{GE} \geq 15V$, $T_j \leq 150^\circ C$)

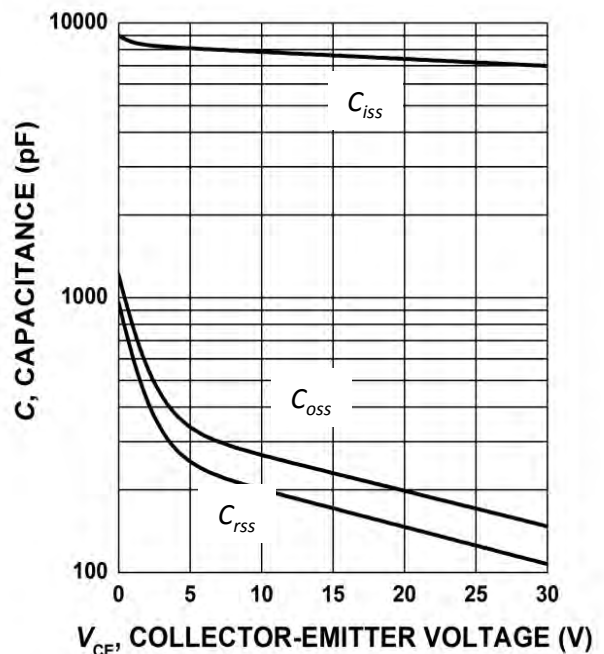

Figure 2. Typical capacitance as a function of collector-emitter voltage ($V_{GE}=0V$, $f = 1$ MHz)



SG40T120DB

Discrete IGBTs

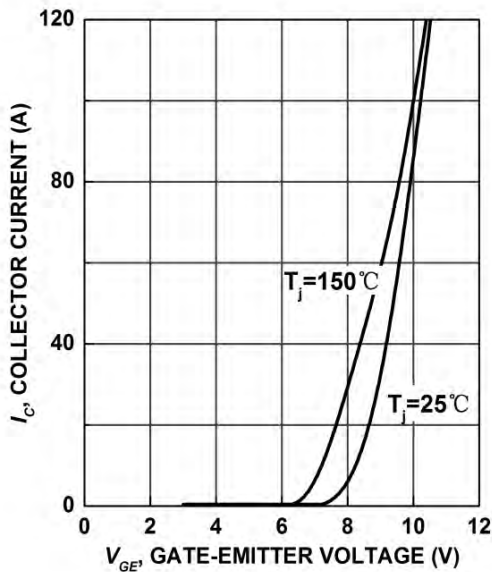

Figure 3. Typical transfer characteristic ($V_{CE}=15\text{V}$)

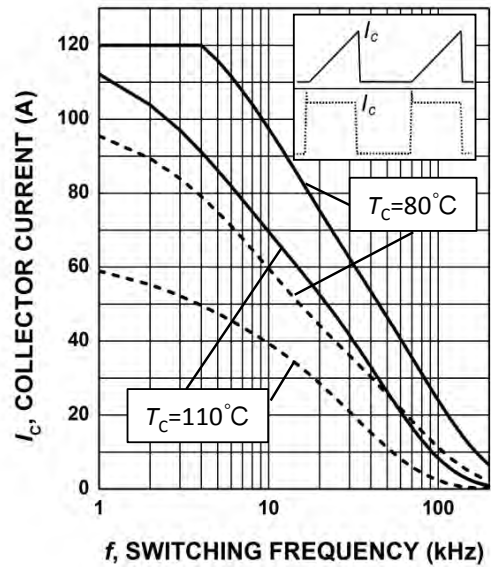

Figure 4. Collector current as a function of switching frequency ($T_j \leq 150^\circ\text{C}$, $D = 0.5$, $V_{CE} = 600\text{V}$, $V_{GE} = 0/+15\text{V}$, $R_G = 12\Omega$)

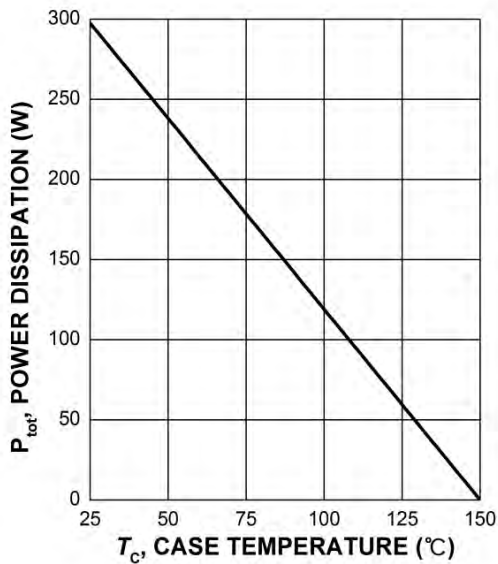

Figure 5. Maximum power dissipation as a function of case temperature ($T_j \leq 150^\circ\text{C}$)

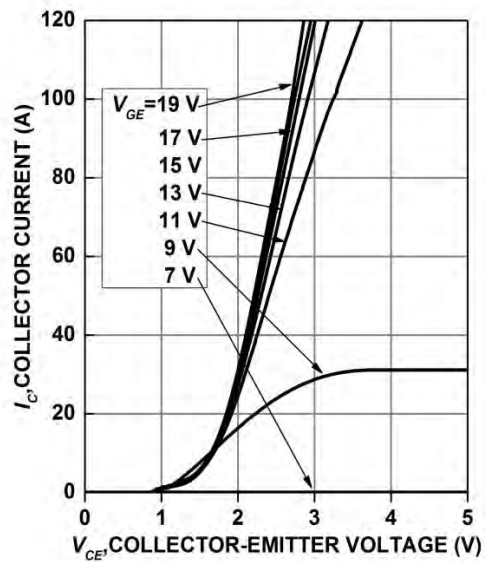

Figure 6. Typical output characteristic ($T_j = 25^\circ\text{C}$)

SG40T120DB

Discrete IGBTs

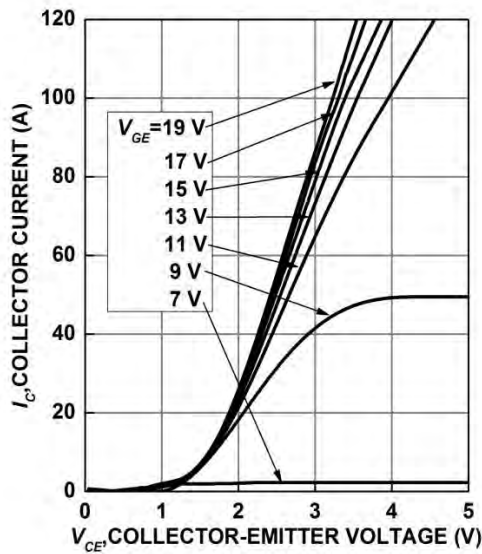

Figure 7. Typical output characteristic ($T_j = 150^\circ\text{C}$)

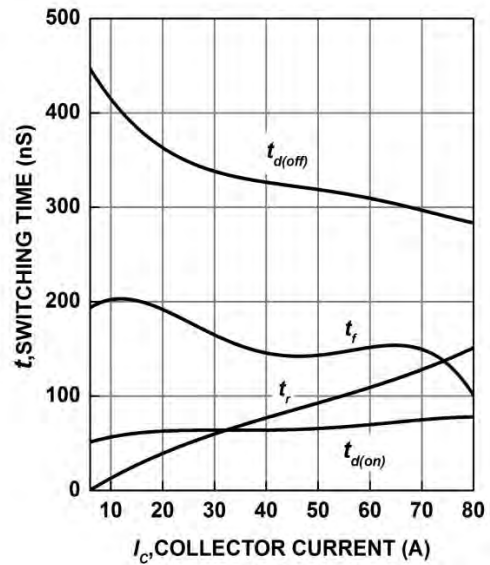

Figure 8. Typical switching times as a function of collector current (inductive load, $T_j=150^\circ\text{C}$, $V_{CE}=600\text{V}$, $V_{GE}=0/15\text{V}$, $R_G=12\Omega$, Dynamic test circuit in Figure D)

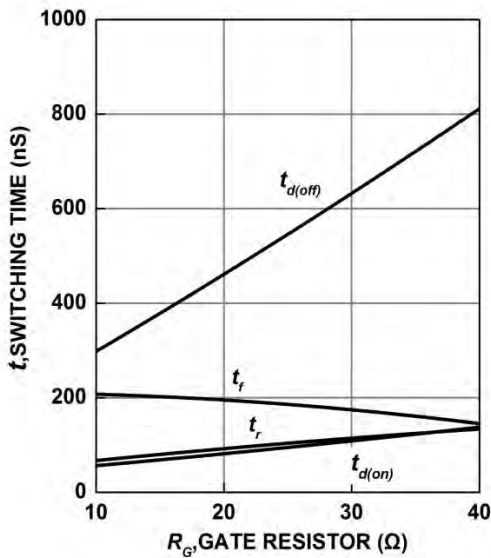

Figure 9. Typical switching times as a function of gate resistor (inductive load, $T_j=150^\circ\text{C}$, $V_{CE}=600\text{V}$, $V_{GE}=0/15\text{V}$, $I_C=40\text{A}$, Dynamic test circuit in Figure D)

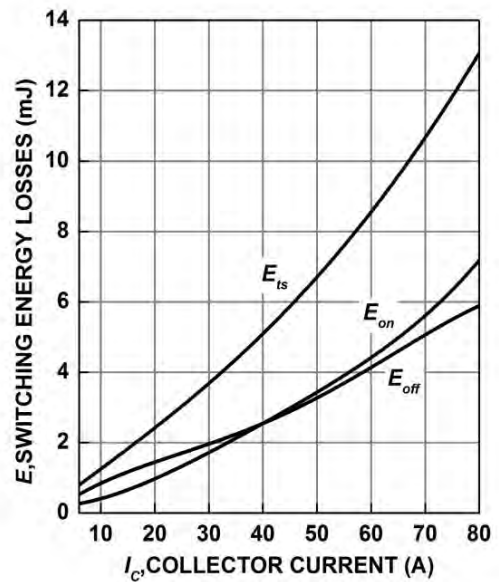

Figure 10. Typical switching energy losses as a function of collector current (inductive load, $T_j=150^\circ\text{C}$, $V_{CE}=600\text{V}$, $V_{GE}=0/15\text{V}$, $R_G=12\Omega$, Dynamic test circuit in Figure D)



SG40T120DB

Discrete IGBTs

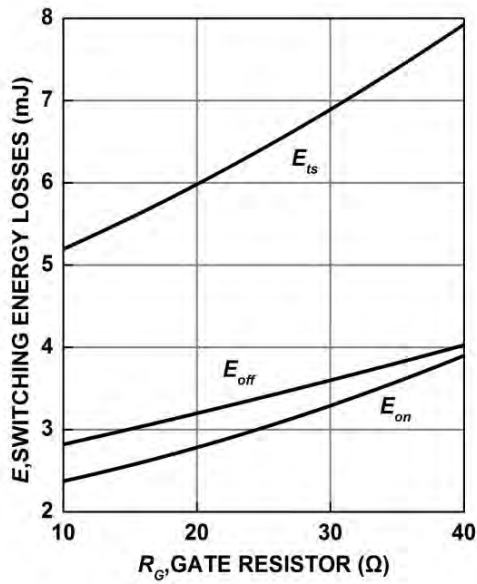

Figure 11. Typical switching energy losses as a function of gate resistor (inductive load, $T_j=150^{\circ}\text{C}$, $V_{CE}=600\text{V}$, $V_{GE}=0/15\text{V}$, $I_C=40\text{A}$, Dynamic test circuit in Figure D)

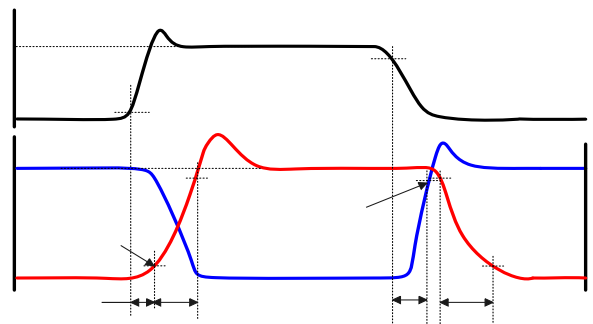

Figure A. Definition of switching times

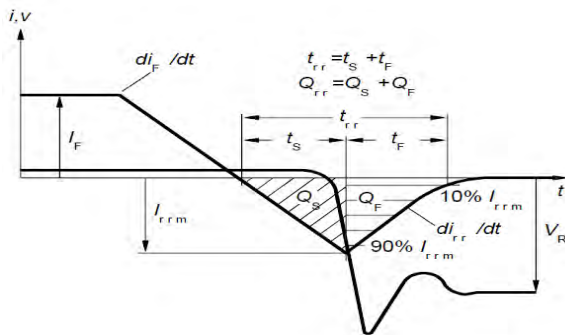

Figure C. Definition of diodes switching characteristics

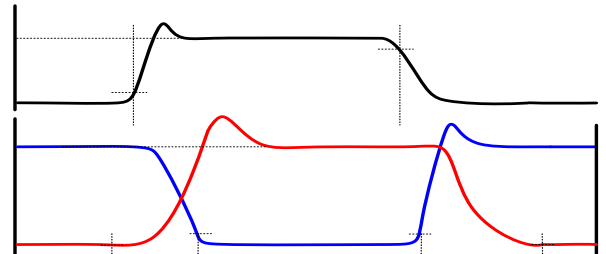

Figure B. Definition of switching losses

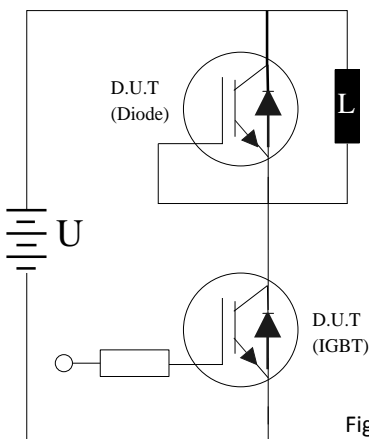

Figure D. Dynamic test circuit