



ON Semiconductor®

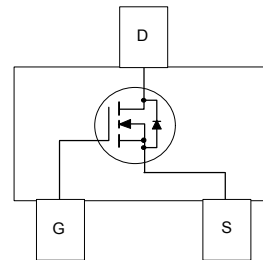
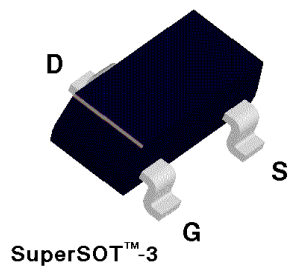
## NDS331N N-Channel Logic Level Enhancement Mode Field Effect Transistor

### General Description

These N-Channel logic level enhancement mode power field effect transistors are produced using ON Semiconductor's proprietary, high cell density, DMOS technology. This very high density process is especially tailored to minimize on-state resistance. These devices are particularly suited for low voltage applications in notebook computers, portable phones, PCMCIA cards, and other battery powered circuits where fast switching, and low in-line power loss are needed in a very small outline surface mount package.

### Features

- 1.3 A, 20 V.  $R_{DS(ON)} = 0.21 \Omega @ V_{GS} = 2.7 V$   
 $R_{DS(ON)} = 0.16 \Omega @ V_{GS} = 4.5 V.$
- Industry standard outline SOT-23 surface mount package using proprietary SuperSOT™-3 design for superior thermal and electrical capabilities.
- High density cell design for extremely low  $R_{DS(ON)}$ .
- Exceptional on-resistance and maximum DC current capability.



### Absolute Maximum Ratings $T_A = 25^\circ C$ unless otherwise noted

Symbol	Parameter	NDS331N	Units
$V_{DSS}$	Drain-Source Voltage	20	V
$V_{GSS}$	Gate-Source Voltage - Continuous	8	V
$I_D$	Maximum Drain Current - Continuous (Note 1a)	1.3	A
	- Pulsed	10	
$P_D$	Maximum Power Dissipation (Note 1a)	0.5	W
		(Note 1b)	
$T_J, T_{STG}$	Operating and Storage Temperature Range	-55 to 150	$^\circ C$

### THERMAL CHARACTERISTICS

$R_{\theta JA}$	Thermal Resistance, Junction-to-Ambient (Note 1a)	250	$^\circ C/W$
$R_{\theta JC}$	Thermal Resistance, Junction-to-Case (Note 1)	75	$^\circ C/W$

NDS331N N-Channel Logic Level Enhancement Mode Field Effect Transistor

ELECTRICAL CHARACTERISTICS (T <sub>A</sub> = 25°C unless otherwise noted)						
Symbol	Parameter	Conditions	Min	Typ	Max	Units
<b>OFF CHARACTERISTICS</b>						
BV <sub>DSS</sub>	Drain-Source Breakdown Voltage	V <sub>GS</sub> = 0 V, I <sub>D</sub> = 250 μA	20			V
I <sub>DSS</sub>	Zero Gate Voltage Drain Current	V <sub>DS</sub> = 16 V, V <sub>GS</sub> = 0 V T <sub>J</sub> = 125°C			1	μA
					10	μA
I <sub>GSSF</sub>	Gate - Body Leakage, Forward	V <sub>GS</sub> = 8 V, V <sub>DS</sub> = 0 V			100	nA
I <sub>GSSR</sub>	Gate - Body Leakage, Reverse	V <sub>GS</sub> = -8 V, V <sub>DS</sub> = 0 V			-100	nA
<b>ON CHARACTERISTICS (Note 2)</b>						
V <sub>GS(th)</sub>	Gate Threshold Voltage	V <sub>DS</sub> = V <sub>GS</sub> , I <sub>D</sub> = 250 μA T <sub>J</sub> = 125°C	0.5	0.7	1	V
			0.3	0.53	0.8	
R <sub>DS(on)</sub>	Static Drain-Source On-Resistance	V <sub>GS</sub> = 2.7 V, I <sub>D</sub> = 1.3 A T <sub>J</sub> = 125°C		0.15	0.21	Ω
				0.24	0.4	
			V <sub>GS</sub> = 4.5 V, I <sub>D</sub> = 1.5 A		0.11	
I <sub>D(on)</sub>	On-State Drain Current	V <sub>GS</sub> = 2.7 V, V <sub>DS</sub> = 5 V V <sub>GS</sub> = 4.5 V, V <sub>DS</sub> = 5 V	3			A
			4			
g <sub>FS</sub>	Forward Transconductance	V <sub>DS</sub> = 5 V, I <sub>D</sub> = 1.3 A,		3.5		S
<b>DYNAMIC CHARACTERISTICS</b>						
C <sub>iss</sub>	Input Capacitance	V <sub>DS</sub> = 10 V, V <sub>GS</sub> = 0 V, f = 1.0 MHz		162		pF
C <sub>oss</sub>	Output Capacitance			85		pF
C <sub>rss</sub>	Reverse Transfer Capacitance			28		pF
<b>SWITCHING CHARACTERISTICS (Note 2)</b>						
t <sub>D(on)</sub>	Turn - On Delay Time	V <sub>DD</sub> = 5 V, I <sub>D</sub> = 1 A, V <sub>GS</sub> = 5 V, R <sub>Gen</sub> = 6 Ω		5	20	ns
t <sub>r</sub>	Turn - On Rise Time			25	40	ns
t <sub>D(off)</sub>	Turn - Off Delay Time			10	20	ns
t <sub>f</sub>	Turn - Off Fall Time			5	20	ns
Q <sub>g</sub>	Total Gate Charge	V <sub>DS</sub> = 5 V, I <sub>D</sub> = 1.3 A, V <sub>GS</sub> = 4.5 V		3.5	5	nC
Q <sub>gs</sub>	Gate-Source Charge			0.3		nC
Q <sub>gd</sub>	Gate-Drain Charge			1		nC

**Electrical Characteristics** ( $T_A = 25^\circ\text{C}$  unless otherwise noted)

Symbol	Parameter	Conditions	Min	Typ	Max	Units
<b>DRAIN-SOURCE DIODE CHARACTERISTICS AND MAXIMUM RATINGS</b>						
$I_S$	Maximum Continuous Drain-Source Diode Forward Current				0.42	A
$I_{SM}$	Maximum Pulsed Drain-Source Diode Forward Current				10	A
$V_{SD}$	Drain-Source Diode Forward Voltage	$V_{GS} = 0\text{ V}, I_S = 0.42\text{ A}$ (Note 2)		0.8	1.2	V

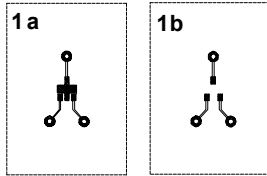
Notes:

- $R_{\theta JA}$  is the sum of the junction-to-case and case-to-ambient thermal resistance where the case thermal reference is defined as the solder mounting surface of the drain pins.  $R_{\theta JC}$  is guaranteed by design while  $R_{\theta CA}$  is determined by the user's board design.

$$P_D(t) = \frac{I_D \cdot I_A}{R_{\theta J A(t)}} = \frac{I_D \cdot I_A}{R_{\theta J C} + R_{\theta C A(t)}} = I_D^2(t) \times R_{DS(on)} \theta_{TJ}$$

Typical  $R_{\theta JA}$  using the board layouts shown below on 4.5"x5" FR-4 PCB in a still air environment:

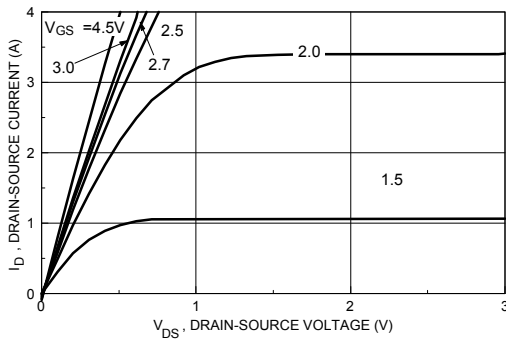
- 250°C/W when mounted on a 0.02 in<sup>2</sup> pad of 2oz copper.
- 270°C/W when mounted on a 0.001 in<sup>2</sup> pad of 2oz copper.



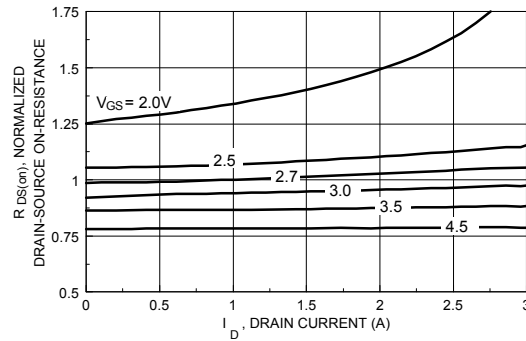
Scale 1 : 1 on letter size paper

- Pulse Test: Pulse Width  $\leq 300\mu\text{s}$ , Duty Cycle  $\leq 2.0\%$ .

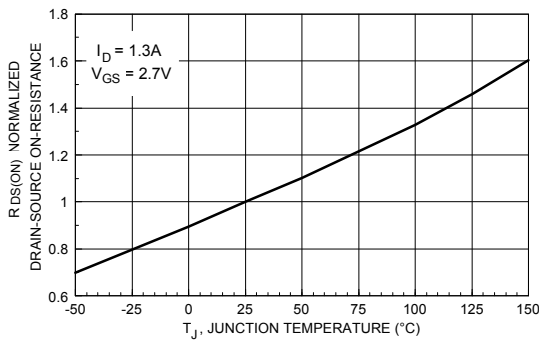
**Typical Electrical Characteristics**



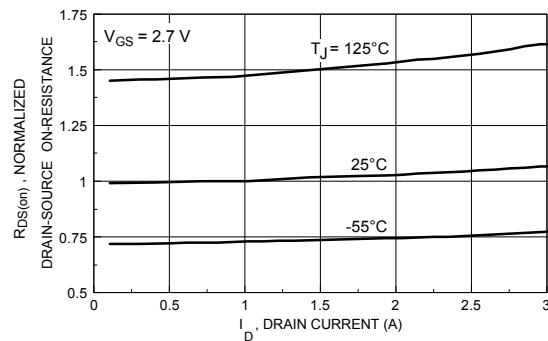
**Figure 1. On-Region Characteristics.**



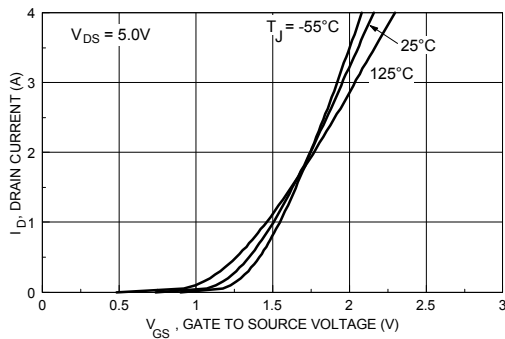
**Figure 2. On-Resistance Variation with Drain Current and Gate Voltage.**



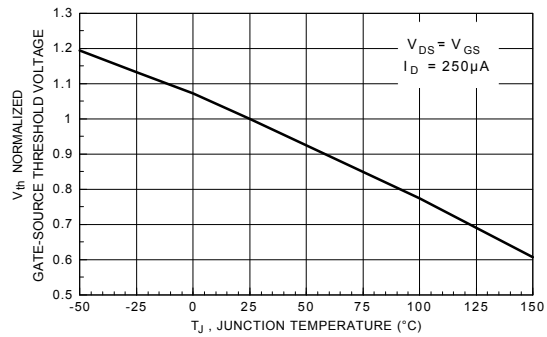
**Figure 3. On-Resistance Variation with Temperature.**



**Figure 4. On-Resistance Variation with Drain Current and Temperature.**

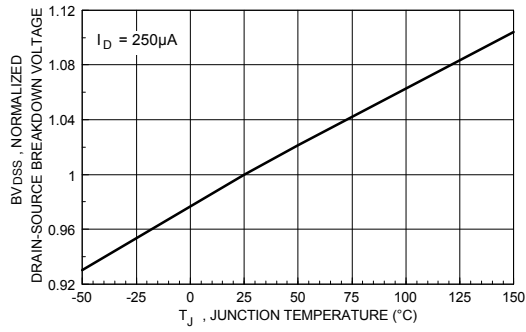


**Figure 5. Transfer Characteristics.**

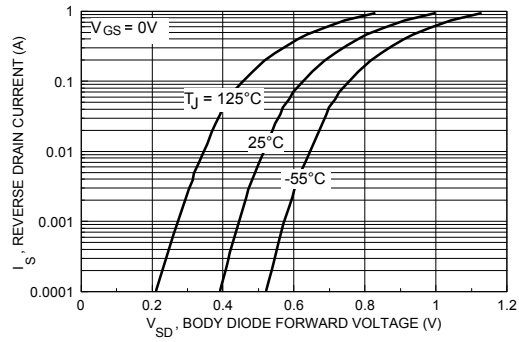


**Figure 6. Gate Threshold Variation with Temperature.**

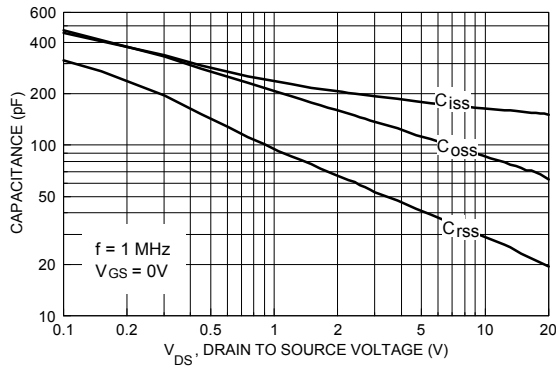
**Typical Electrical Characteristics (continued)**



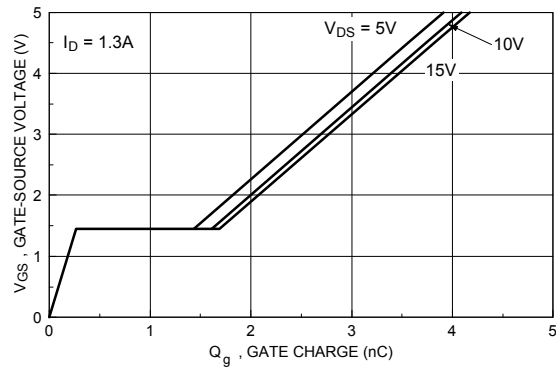
**Figure 7. Breakdown Voltage Variation with Temperature.**



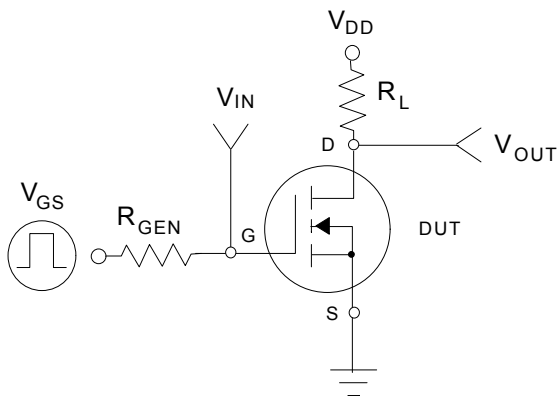
**Figure 8. Body Diode Forward Voltage Variation with Source Current and Temperature.**



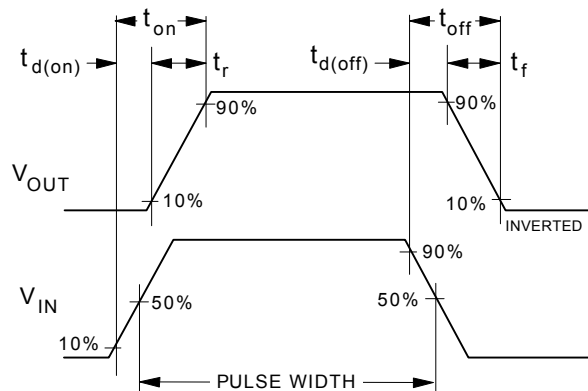
**Figure 9. Capacitance Characteristics.**



**Figure 10. Gate Charge Characteristics.**

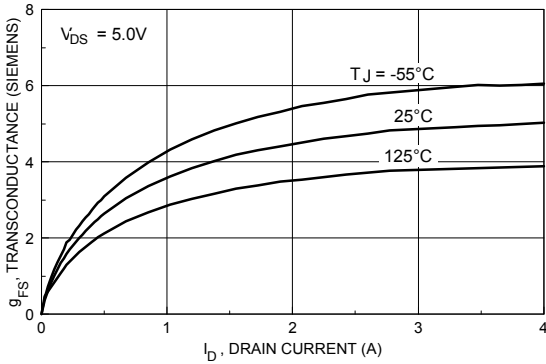


**Figure 11. Switching Test Circuit.**

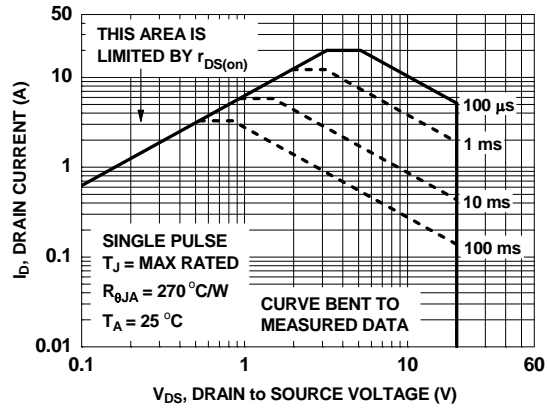


**Figure 12. Switching Waveforms.**

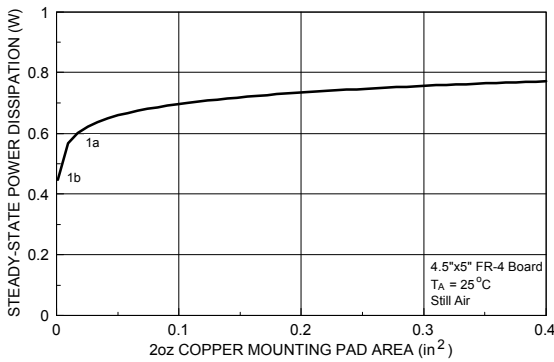
**Typical Electrical Characteristics (continued)**



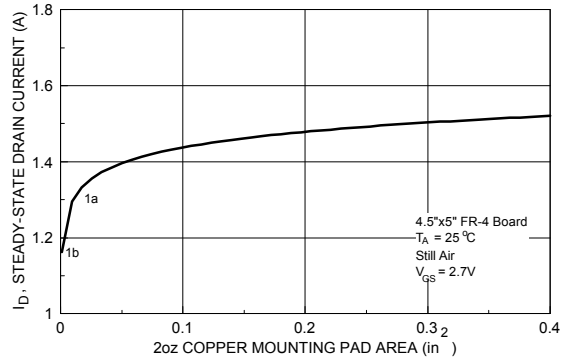
**Figure 13. Transconductance Variation with Drain Current and Temperature.**



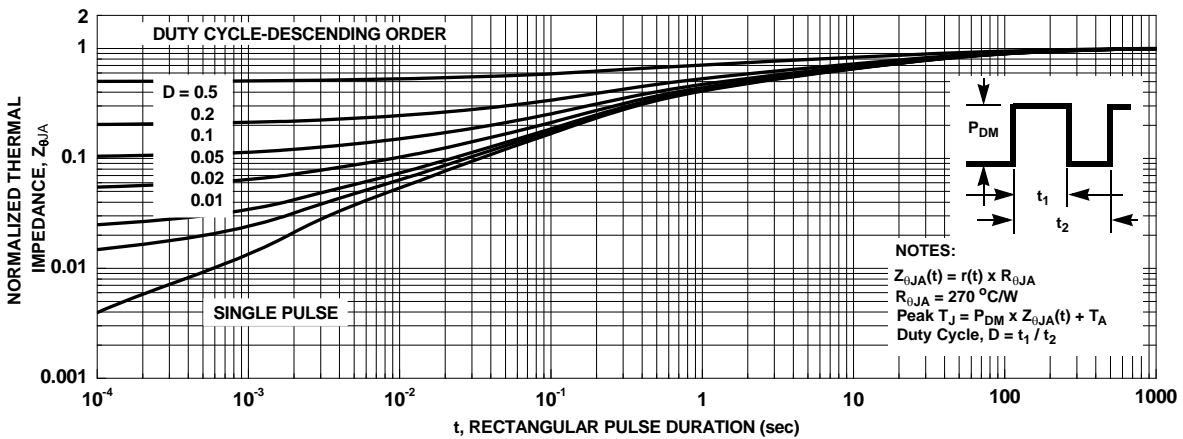
**Figure 14. Maximum Safe Operating Area.**



**Figure 15. SuperSOT™ - 3 Maximum Steady-State Power Dissipation versus Copper Mounting Pad Area.**



**Figure 16. Maximum Steady-State Drain Current versus Copper Mounting Pad Area.**



**Figure 17. Transient Thermal Response Curve.**

Note : Thermal characterization performed using the conditions described in note 1b. response will change depending on the circuit board design.

ON Semiconductor and  are trademarks of Semiconductor Components Industries, LLC dba ON Semiconductor or its subsidiaries in the United States and/or other countries. ON Semiconductor owns the rights to a number of patents, trademarks, copyrights, trade secrets, and other intellectual property. A listing of ON Semiconductor's product/patent coverage may be accessed at [www.onsemi.com/site/pdf/Patent-Marking.pdf](http://www.onsemi.com/site/pdf/Patent-Marking.pdf). ON Semiconductor reserves the right to make changes without further notice to any products herein. ON Semiconductor makes no warranty, representation or guarantee regarding the suitability of its products for any particular purpose, nor does ON Semiconductor assume any liability arising out of the application or use of any product or circuit, and specifically disclaims any and all liability, including without limitation special, consequential or incidental damages. Buyer is responsible for its products and applications using ON Semiconductor products, including compliance with all laws, regulations and safety requirements or standards, regardless of any support or applications information provided by ON Semiconductor. "Typical" parameters which may be provided in ON Semiconductor data sheets and/or specifications can and do vary in different applications and actual performance may vary over time. All operating parameters, including "Typicals" must be validated for each customer application by customer's technical experts. ON Semiconductor does not convey any license under its patent rights nor the rights of others. ON Semiconductor products are not designed, intended, or authorized for use as a critical component in life support systems or any FDA Class 3 medical devices or medical devices with a same or similar classification in a foreign jurisdiction or any devices intended for implantation in the human body. Should Buyer purchase or use ON Semiconductor products for any such unintended or unauthorized application, Buyer shall indemnify and hold ON Semiconductor and its officers, employees, subsidiaries, affiliates, and distributors harmless against all claims, costs, damages, and expenses, and reasonable attorney fees arising out of, directly or indirectly, any claim of personal injury or death associated with such unintended or unauthorized use, even if such claim alleges that ON Semiconductor was negligent regarding the design or manufacture of the part. ON Semiconductor is an Equal Opportunity/Affirmative Action Employer. This literature is subject to all applicable copyright laws and is not for resale in any manner.

## PUBLICATION ORDERING INFORMATION

### LITERATURE FULFILLMENT:

Literature Distribution Center for ON Semiconductor  
19521 E. 32nd Pkwy, Aurora, Colorado 80011 USA  
**Phone:** 303-675-2175 or 800-344-3860 Toll Free USA/Canada  
**Fax:** 303-675-2176 or 800-344-3867 Toll Free USA/Canada  
**Email:** [orderlit@onsemi.com](mailto:orderlit@onsemi.com)

**N. American Technical Support:** 800-282-9855 Toll Free  
USA/Canada  
**Europe, Middle East and Africa Technical Support:**  
Phone: 421 33 790 2910  
**Japan Customer Focus Center**  
Phone: 81-3-5817-1050

**ON Semiconductor Website:** [www.onsemi.com](http://www.onsemi.com)  
**Order Literature:** <http://www.onsemi.com/orderlit>  
For additional information, please contact your local  
Sales Representative