



Is Now Part of



ON Semiconductor®

To learn more about ON Semiconductor, please visit our website at
www.onsemi.com

ON Semiconductor and the ON Semiconductor logo are trademarks of Semiconductor Components Industries, LLC dba ON Semiconductor or its subsidiaries in the United States and/or other countries. ON Semiconductor owns the rights to a number of patents, trademarks, copyrights, trade secrets, and other intellectual property. A listing of ON Semiconductor's product/patent coverage may be accessed at www.onsemi.com/site/pdf/Patent-Marking.pdf. ON Semiconductor reserves the right to make changes without further notice to any products herein. ON Semiconductor makes no warranty, representation or guarantee regarding the suitability of its products for any particular purpose, nor does ON Semiconductor assume any liability arising out of the application or use of any product or circuit, and specifically disclaims any and all liability, including without limitation special, consequential or incidental damages. Buyer is responsible for its products and applications using ON Semiconductor products, including compliance with all laws, regulations and safety requirements or standards, regardless of any support or applications information provided by ON Semiconductor. "Typical" parameters which may be provided in ON Semiconductor data sheets and/or specifications can and do vary in different applications and actual performance may vary over time. All operating parameters, including "Typicals" must be validated for each customer application by customer's technical experts. ON Semiconductor does not convey any license under its patent rights nor the rights of others. ON Semiconductor products are not designed, intended, or authorized for use as a critical component in life support systems or any FDA Class 3 medical devices or medical devices with a same or similar classification in a foreign jurisdiction or any devices intended for implantation in the human body. Should Buyer purchase or use ON Semiconductor products for any such unintended or unauthorized application, Buyer shall indemnify and hold ON Semiconductor and its officers, employees, subsidiaries, affiliates, and distributors harmless against all claims, costs, damages, and expenses, and reasonable attorney fees arising out of, directly or indirectly, any claim of personal injury or death associated with such unintended or unauthorized use, even if such claim alleges that ON Semiconductor was negligent regarding the design or manufacture of the part. ON Semiconductor is an Equal Opportunity/Affirmative Action Employer. This literature is subject to all applicable copyright laws and is not for resale in any manner.



FDMS5672

N-Channel UltraFET Trench[®] MOSFET

60V, 22A, 11.5mΩ

Features

- Max $r_{DS(on)}$ = 11.5mΩ at $V_{GS} = 10V$, $I_D = 10.6A$
- Max $r_{DS(on)}$ = 16.5mΩ at $V_{GS} = 6V$, $I_D = 8A$
- Typ Qg = 32nC at $V_{GS} = 10V$
- Low Miller Charge
- Optimized Efficiency at High Frequencies
- RoHS Compliant



General Description

UltraFET devices combine characteristics that enable benchmark efficiency in power conversion applications. Optimized for $r_{DS(on)}$, low ESR, low total and Miller gate charge, these devices are ideal for high frequency DC to DC converters.

Application

- DC - DC Conversion

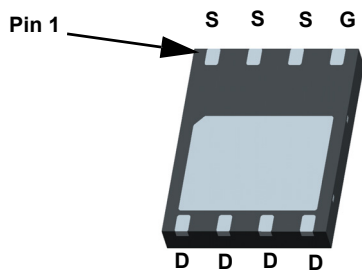

Power 56 (Bottom view)

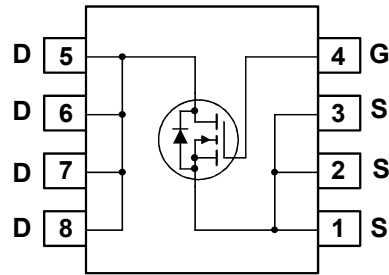

MOSFET Maximum Ratings $T_A = 25^\circ C$ unless otherwise noted.

Symbol	Parameter	Ratings	Units
V_{DS}	Drain to Source Voltage	60	V
V_{GS}	Gate to Source Voltage	± 20	V
I_D	Drain Current -Continuous	$T_C = 25^\circ C$ (Note 5)	65
	-Continuous	$T_C = 100^\circ C$ (Note 5)	39
	-Continuous	$T_A = 25^\circ C$ (Note 1a)	10.6
	-Pulsed	(Note 4)	176
E_{AS}	Single Pulse Avalanche Energy	(Note 3)	337
P_D	Power Dissipation	$T_C = 25^\circ C$	78
	Power Dissipation	$T_A = 25^\circ C$ (Note 1a)	2.5
T_J, T_{STG}	Operating and Storage Junction Temperature Range	-55 to +150	$^\circ C$

Thermal Characteristics

$R_{\theta JC}$	Thermal Resistance, Junction to Case	1.6	$^\circ C/W$
$R_{\theta JA}$	Thermal Resistance, Junction to Ambient (Note 1a)	50	

Package Marking and Ordering Information

Device Marking	Device	Package	Reel Size	Tape Width	Quantity
FDMS5672	FDMS5672	Power 56	13"	12mm	3000 units

FDMS5672 N-Channel UltraFET Trench[®] MOSFET

Electrical Characteristics $T_J = 25^\circ\text{C}$ unless otherwise noted.

Symbol	Parameter	Test Conditions	Min.	Typ.	Max.	Units
--------	-----------	-----------------	------	------	------	-------

Off Characteristics

BV_{DSS}	Drain to Source Breakdown Voltage	$I_D = 250\mu\text{A}, V_{GS} = 0\text{V}$	60			V
$\frac{\Delta BV_{DSS}}{\Delta T_J}$	Breakdown Voltage Temperature Coefficient	$I_D = 250\mu\text{A}$, referenced to 25°C		59		mV/ $^\circ\text{C}$
I_{DSS}	Zero Gate Voltage Drain Current	$V_{DS} = 48\text{V}, V_{GS} = 0\text{V}$			1	μA
I_{GSS}	Gate to Source Leakage Current	$V_{GS} = \pm 20\text{V}, V_{DS} = 0\text{V}$			± 100	nA

On Characteristics

$V_{GS(th)}$	Gate to Source Threshold Voltage	$V_{GS} = V_{DS}, I_D = 250\mu\text{A}$	2	3.2	4	V
$\frac{\Delta V_{GS(th)}}{\Delta T_J}$	Gate to Source Threshold Voltage Temperature Coefficient	$I_D = 250\mu\text{A}$, referenced to 25°C		-11		mV/ $^\circ\text{C}$
$r_{DS(on)}$	Drain to Source On Resistance	$V_{GS} = 10\text{V}, I_D = 10.6\text{A}$		9.4	11.5	m Ω
		$V_{GS} = 6\text{V}, I_D = 8\text{A}$		13.0	16.5	
		$V_{GS} = 10\text{V}, I_D = 10.6\text{A}, T_J = 125^\circ\text{C}$		15.0	18.0	
g_{FS}	Forward Transconductance	$V_{DS} = 10\text{V}, I_D = 10.6\text{A}$		26		S

Dynamic Characteristics

C_{iss}	Input Capacitance	$V_{DS} = 30\text{V}, V_{GS} = 0\text{V}, f = 1\text{MHz}$		2100	2800	pF
C_{oss}	Output Capacitance			375	500	pF
C_{rss}	Reverse Transfer Capacitance			120	180	pF
R_g	Gate Resistance	$f = 1\text{MHz}$		1.2		Ω

Switching Characteristics

$t_{d(on)}$	Turn-On Delay Time	$V_{DD} = 30\text{V}, I_D = 10.6\text{A}, V_{GS} = 10\text{V}, R_{GEN} = 6\Omega$		16	29	ns
t_r	Rise Time			17	31	ns
$t_{d(off)}$	Turn-Off Delay Time			22	35	ns
t_f	Fall Time			8	16	ns
$Q_{g(TOT)}$	Total Gate Charge at 10V		$V_{GS} = 0\text{V to } 10\text{V}$		32	45
Q_{gs}	Gate to Source Gate Charge	$V_{DD} = 30\text{V}, I_D = 10.6\text{A}$		10		nC
Q_{gd}	Gate to Drain "Miller" Charge			8.3		nC

Drain-Source Diode Characteristics

V_{SD}	Source to Drain Diode Forward Voltage	$V_{GS} = 0\text{V}, I_S = 10.6\text{A}$ (Note 2)		0.80	1.20	V
t_{rr}	Reverse Recovery Time	$I_F = 10.6\text{A}, di/dt = 100\text{A}/\mu\text{s}$		35	53	ns
Q_{rr}	Reverse Recovery Charge			42	63	nC

Notes:

- $R_{\theta JA}$ is determined with the device mounted on a 1in^2 pad 2 oz copper pad on a 1.5×1.5 in. board of FR-4 material. $R_{\theta JC}$ is guaranteed by design while $R_{\theta CA}$ is determined by the user's board design.

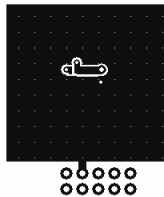

a. $50^\circ\text{C}/\text{W}$ when mounted on a 1in^2 pad of 2 oz copper



b. $125^\circ\text{C}/\text{W}$ when mounted on a minimum pad of 2 oz copper

- Pulse Test: Pulse Width $< 300\mu\text{s}$, Duty cycle $< 2.0\%$.
- Starting $T_J = 25^\circ\text{C}$, $L = 3\text{mH}$, $I_{AS} = 15\text{A}$, $V_{DD} = 60\text{V}$, $V_{GS} = 10\text{V}$.
- Pulsed I_d please refer to Fig 11 SOA graph for more details.
- Computed continuous current limited to Max Junction Temperature only, actual continuous current will be limited by thermal & electro-mechanical application board design.

Typical Characteristics $T_J = 25^\circ\text{C}$ unless otherwise noted.

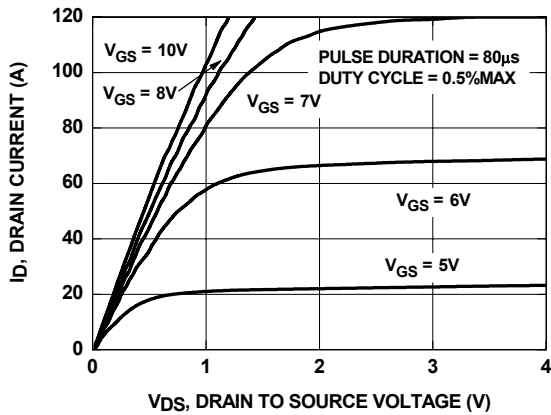

Figure 1. On Region Characteristics

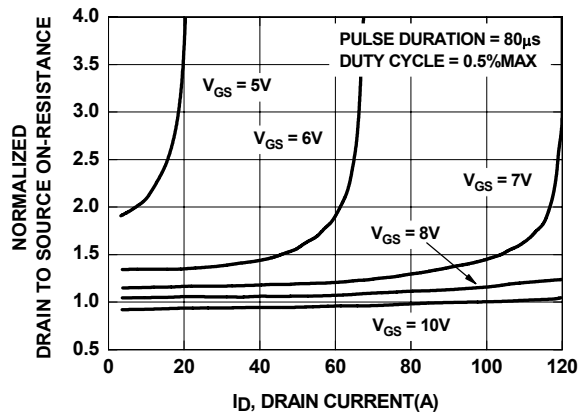

Figure 2. Normalized On-Resistance vs. Drain Current and Gate Voltage

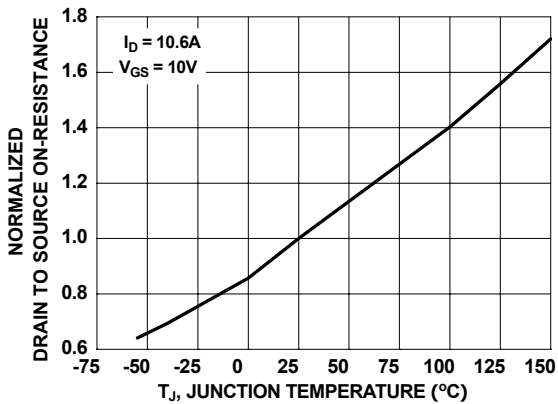

Figure 3. Normalized On Resistance vs. Junction Temperature

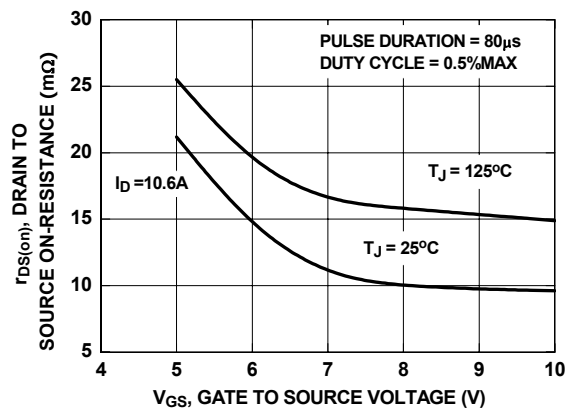

Figure 4. On-Resistance vs. Gate to Source Voltage

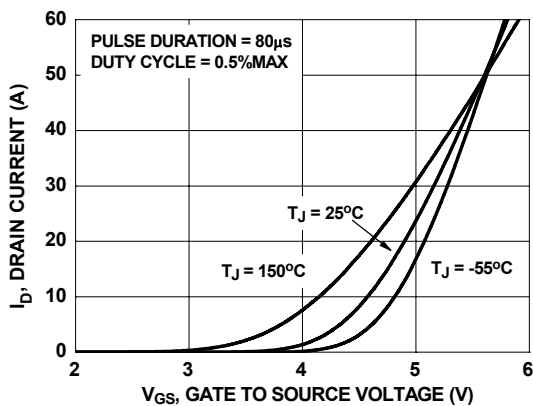

Figure 5. Transfer Characteristics

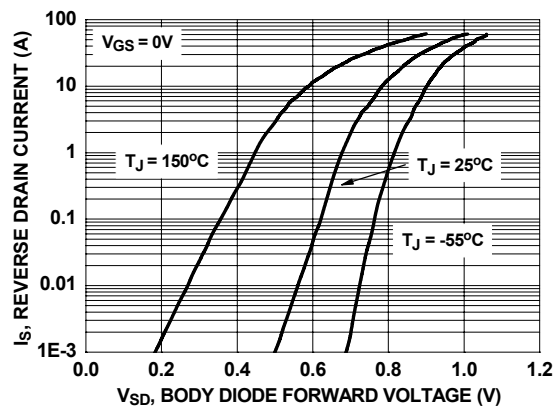

Figure 6. Source to Drain Diode Forward Voltage vs. Source Current

Typical Characteristics $T_J = 25^\circ\text{C}$ unless otherwise noted.

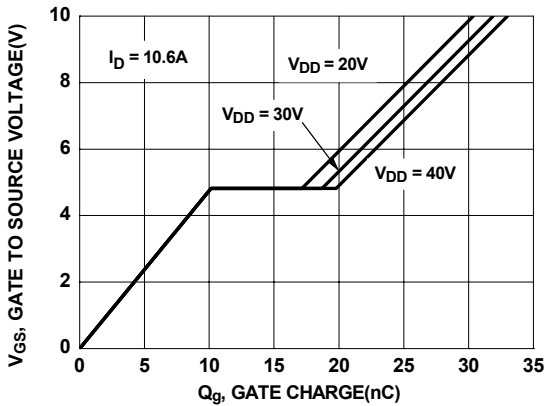

Figure 7. Gate Charge Characteristics

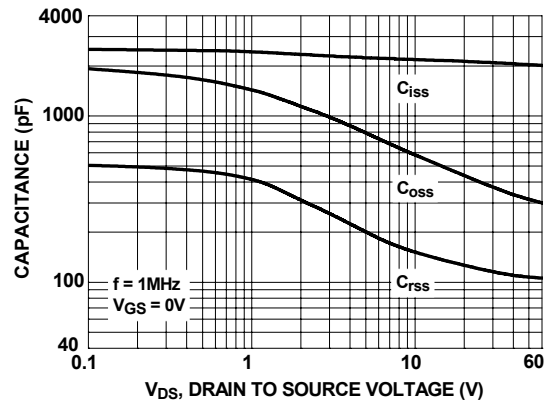

Figure 8. Capacitance vs. Drain to Source Voltage

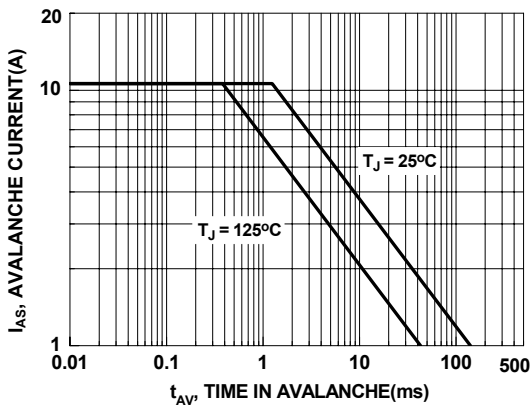

Figure 9. Unclamped Inductive Switching Capability

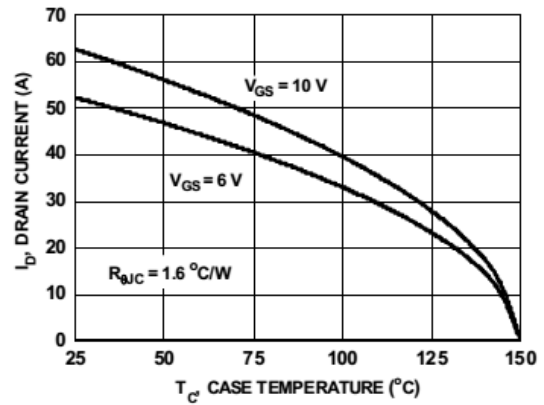

Figure 10. Maximum Continuous Drain Current vs. Case Temperature

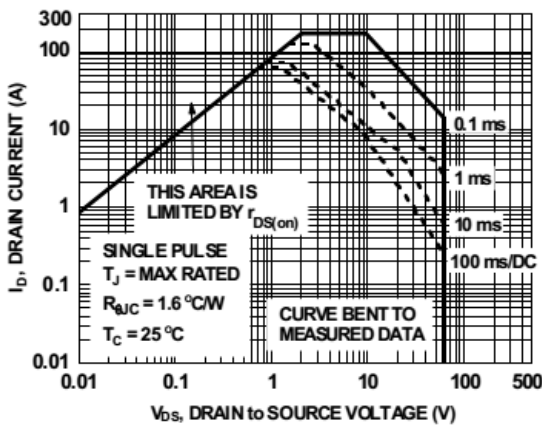

Figure 11. Forward Bias Safe Operating Area

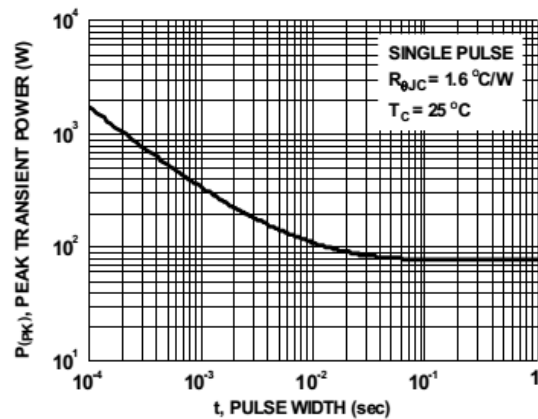

Figure 12. Single Pulse Maximum Power Dissipation

Typical Characteristics $T_J = 25^\circ\text{C}$ unless otherwise noted.

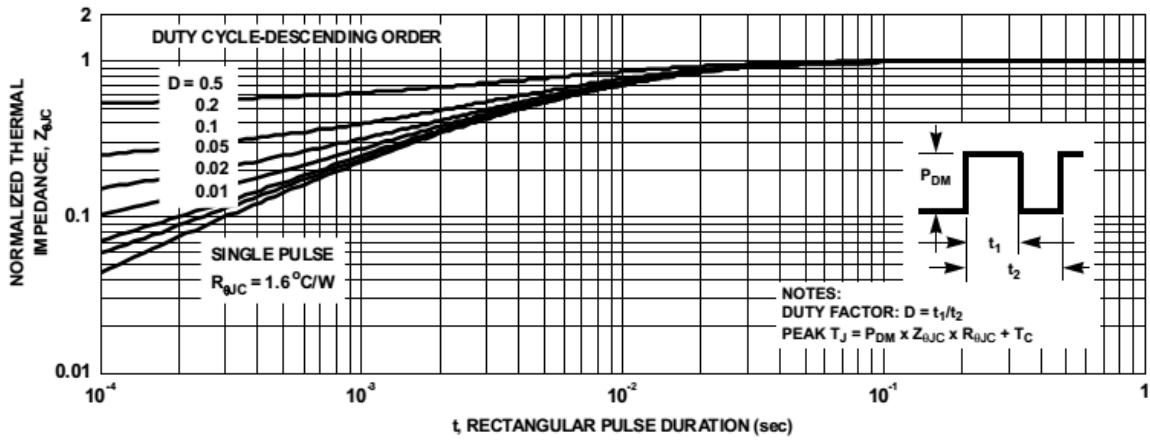
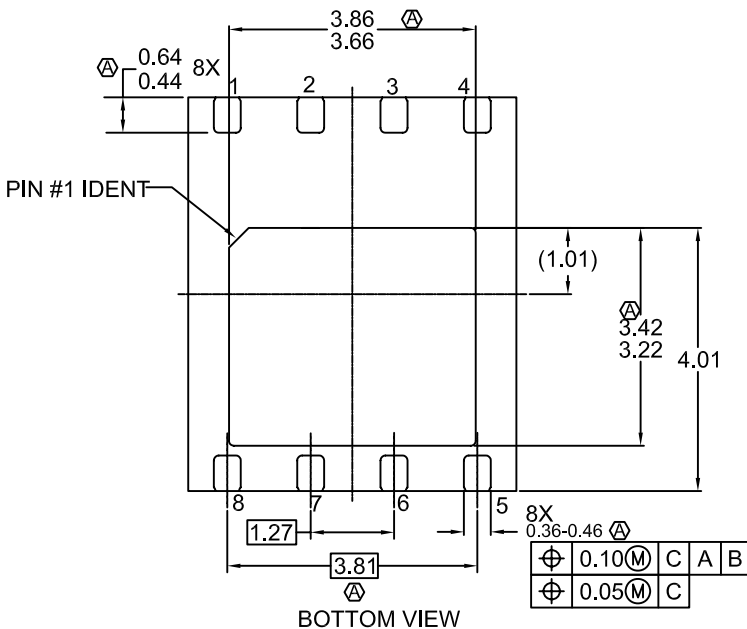
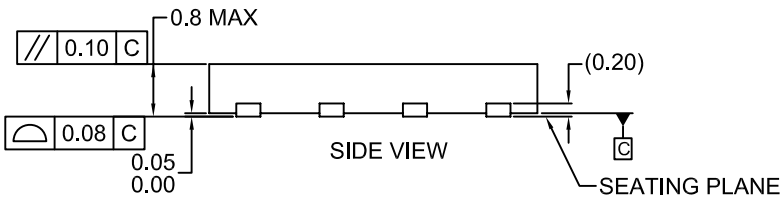
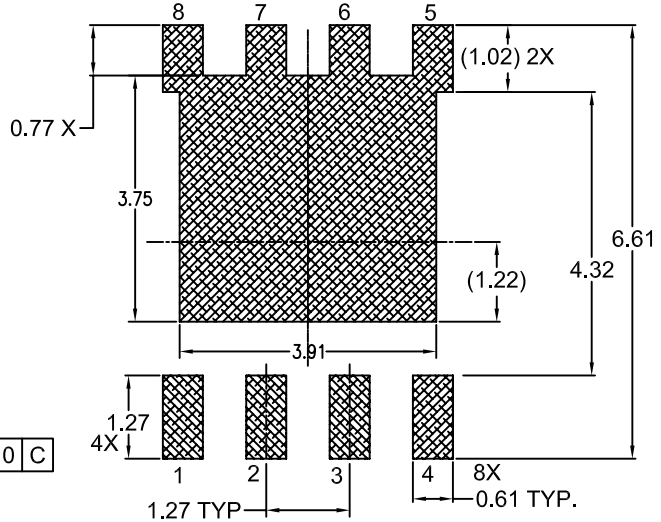
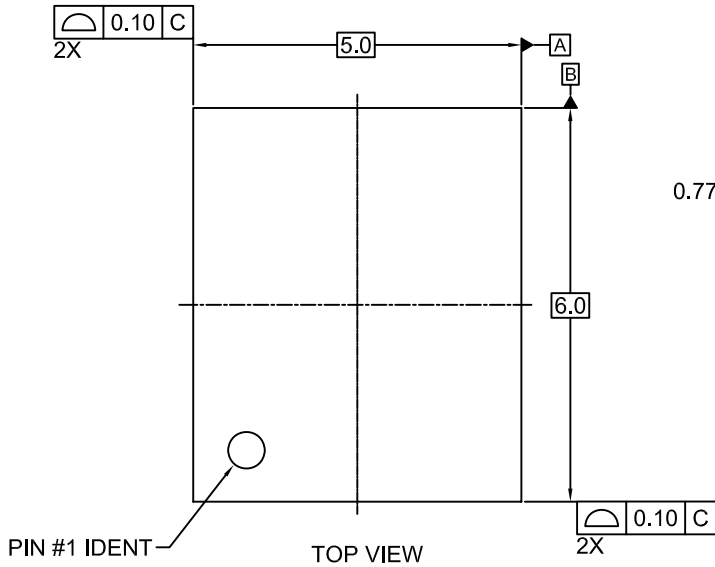

Figure 13. Transient Thermal Response Curve

REVISIONS			
NBR	DESCRIPTION	DATE	NAME/SITE
1	RELEASE TO DOCUMENT CONTROL	090305	David/FSPM
2	REVISE TO CORRECT DAP SIZE	080605	David/FSPM
3	I) REVISE TO CORRECT PKG THK II) REVISE THE PKG PROFILE TOLERANCE	210306	CK/FSPM
4	ADD IN LEAD LENGTH FOR LAND PATTERN	220908	LY/FSPM



NOTES:

- Ⓐ DOES NOT FULLY CONFORM TO JEDEC REGISTRATION, MO-229.
- B. DIMENSIONS ARE IN MILLIMETERS.
- C. DIMENSIONS AND TOLERANCES PER ASME Y14.5M, 1994
- D. TERMINALS 5,6,7 AND 8 ARE TIED TO THE EXPOSED PADDLE
- E. LANDPATTERN RECOMMENDATION IS BASED ON FSC DESIGN ONLY
- F. DRAWING FILENAME: MKT-MLP08Grev4

APPROVALS	DATE	FAIRCHILD SEMICONDUCTOR™	8LD, MLP, DUAL, NON-JEDEC, 5X6 MM BODY, TIED DAP	SCALE N/A	SIZE N/A	DRAWING NUMBER MKT-MLP08G	REV 4
DRAWN LY Lim	01 Nov 08						
DFTG. CHK. LY LIM	01 Nov 08						
ENGR. CHK. DAVID	01 Nov 08						
PROJECTION		DO NOT SCALE DRAWING		SHEET 1 of 1			

ON Semiconductor and  are trademarks of Semiconductor Components Industries, LLC dba ON Semiconductor or its subsidiaries in the United States and/or other countries. ON Semiconductor owns the rights to a number of patents, trademarks, copyrights, trade secrets, and other intellectual property. A listing of ON Semiconductor's product/patent coverage may be accessed at www.onsemi.com/site/pdf/Patent-Marking.pdf. ON Semiconductor reserves the right to make changes without further notice to any products herein. ON Semiconductor makes no warranty, representation or guarantee regarding the suitability of its products for any particular purpose, nor does ON Semiconductor assume any liability arising out of the application or use of any product or circuit, and specifically disclaims any and all liability, including without limitation special, consequential or incidental damages. Buyer is responsible for its products and applications using ON Semiconductor products, including compliance with all laws, regulations and safety requirements or standards, regardless of any support or applications information provided by ON Semiconductor. "Typical" parameters which may be provided in ON Semiconductor data sheets and/or specifications can and do vary in different applications and actual performance may vary over time. All operating parameters, including "Typicals" must be validated for each customer application by customer's technical experts. ON Semiconductor does not convey any license under its patent rights nor the rights of others. ON Semiconductor products are not designed, intended, or authorized for use as a critical component in life support systems or any FDA Class 3 medical devices or medical devices with a same or similar classification in a foreign jurisdiction or any devices intended for implantation in the human body. Should Buyer purchase or use ON Semiconductor products for any such unintended or unauthorized application, Buyer shall indemnify and hold ON Semiconductor and its officers, employees, subsidiaries, affiliates, and distributors harmless against all claims, costs, damages, and expenses, and reasonable attorney fees arising out of, directly or indirectly, any claim of personal injury or death associated with such unintended or unauthorized use, even if such claim alleges that ON Semiconductor was negligent regarding the design or manufacture of the part. ON Semiconductor is an Equal Opportunity/Affirmative Action Employer. This literature is subject to all applicable copyright laws and is not for resale in any manner.

PUBLICATION ORDERING INFORMATION

LITERATURE FULFILLMENT:

Literature Distribution Center for ON Semiconductor
19521 E. 32nd Pkwy, Aurora, Colorado 80011 USA
Phone: 303-675-2175 or 800-344-3860 Toll Free USA/Canada
Fax: 303-675-2176 or 800-344-3867 Toll Free USA/Canada
Email: orderlit@onsemi.com

N. American Technical Support: 800-282-9855 Toll Free
USA/Canada
Europe, Middle East and Africa Technical Support:
Phone: 421 33 790 2910
Japan Customer Focus Center
Phone: 81-3-5817-1050

ON Semiconductor Website: www.onsemi.com
Order Literature: <http://www.onsemi.com/orderlit>
For additional information, please contact your local
Sales Representative