



N-Channel Enhancement-Mode Vertical DMOS FETs

Features

- ▶ Free from secondary breakdown
- ▶ Low power drive requirement
- ▶ Ease of paralleling
- ▶ Low C_{ISS} and fast switching speeds
- ▶ Excellent thermal stability
- ▶ Integral source-drain diode
- ▶ High input impedance and high gain

Applications

- ▶ Motor controls
- ▶ Converters
- ▶ Amplifiers
- ▶ Switches
- ▶ Power supply circuits
- ▶ Drivers (relays, hammers, solenoids, lamps, memories, displays, bipolar transistors, etc.)

Ordering Information

Part Number	Package Option	Packing
VN2210N2-G	TO-39	500/Bag
TN2106N3-G	TO-92	1000/Bag
TN2106N3-G P002	TO-92	2000/Reel
TN2106N3-G P003		
TN2106N3-G P005		
TN2106N3-G P013		
TN2106N3-G P014		

-G denotes a lead (Pb)-free / RoHS compliant package.
 Contact factory for Wafer / Die availability.
 Devices in Wafer / Die form are lead (Pb)-free / RoHS compliant.

Absolute Maximum Ratings

Parameter	Value
Drain-to-source voltage	BV_{DSS}
Drain-to-gate voltage	BV_{DGS}
Gate-to-source voltage	$\pm 20V$
Operating and storage temperature	$-55^{\circ}C$ to $+150^{\circ}C$

Absolute Maximum Ratings are those values beyond which damage to the device may occur. Functional operation under these conditions is not implied. Continuous operation of the device at the absolute rating level may affect device reliability. All voltages are referenced to device ground.

Typical Thermal Resistance

Package	θ_{ja}
TO-39	N/A
TO-92	$132^{\circ}C/W$

General Description

The Supertex VN2210 is an enhancement-mode (normally-off) transistor that utilizes a vertical DMOS structure and Supertex's well-proven silicon-gate manufacturing process. This combination produces a device with the power handling capabilities of bipolar transistors, and the high input impedance and positive temperature coefficient inherent in MOS devices. Characteristic of all MOS structures, this device is free from thermal runaway and thermally-induced secondary breakdown.

Supertex's vertical DMOS FETs are ideally suited to a wide range of switching and amplifying applications where very low threshold voltage, high breakdown voltage, high input impedance, low input capacitance, and fast switching speeds are desired.

Product Summary

BV_{DSS}/BV_{DGS}	$R_{DS(ON)}$ (max)	$V_{GS(th)}$ (max)
100V	0.35Ω	8.0V

Pin Configuration

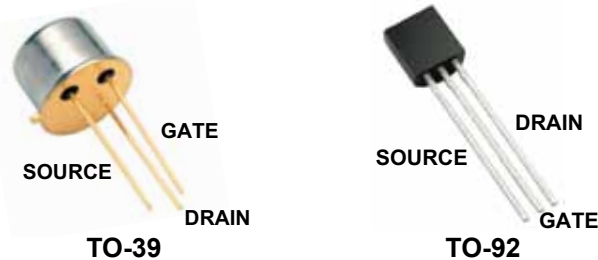

Product Marking

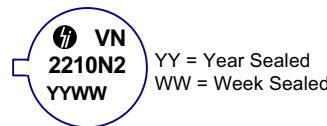

Package may or may not include the following marks: Si or **TO-39**

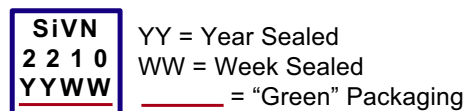

Package may or may not include the following marks: Si or **TO-92**

Thermal Characteristics

Package	I_D (continuous) [†]	I_D (pulsed)	Power Dissipation @ $T_c = 25^\circ\text{C}$	I_{DR} [†]	I_{DRM}
TO-39	1.7A	10A	0.36W	1.7A	10A
TO-92	1.2A	8.0A	0.74W	1.2A	8.0A

Notes:

[†] I_D (continuous) is limited by max rated T_j .

Electrical Characteristics ($T_A = 25^\circ\text{C}$ unless otherwise specified)

Sym	Parameter	Min	Typ	Max	Units	Conditions
BV_{DSS}	Drain-to-source breakdown voltage	100	-	-	V	$V_{GS} = 0\text{V}, I_D = 10\text{mA}$
$V_{GS(th)}$	Gate threshold voltage	0.8	-	2.4	V	$V_{GS} = V_{DS}, I_D = 10\text{mA}$
$\Delta V_{GS(th)}$	Change in $V_{GS(th)}$ with temperature	-	-4.3	-5.5	mV/ $^\circ\text{C}$	$V_{GS} = V_{DS}, I_D = 10\text{mA}$
I_{GSS}	Gate body leakage current	-	-	100	nA	$V_{GS} = \pm 20\text{V}, V_{DS} = 0\text{V}$
I_{DSS}	Zero gate voltage drain current	-	-	50	μA	$V_{GS} = 0\text{V}, V_{DS} = \text{Max Rating}$
		-	-	10	mA	$V_{DS} = 0.8 \text{ Max Rating}, V_{GS} = 0\text{V}, T_A = 125^\circ\text{C}$
$I_{D(ON)}$	On-state drain current	3.0	4.5	-	A	$V_{GS} = 5.0\text{V}, V_{DS} = 25\text{V}$
		8.0	17	-		$V_{GS} = 10\text{V}, V_{DS} = 25\text{V}$
$R_{DS(ON)}$	Static drain-to-source on-state resistance	-	0.4	0.5	Ω	$V_{GS} = 5.0\text{V}, I_D = 1.0\text{A}$
		-	0.27	0.35		$V_{GS} = 10\text{V}, I_D = 4.0\text{A}$
$\Delta R_{DS(ON)}$	Change in $R_{DS(ON)}$ with temperature	-	0.85	1.2	%/ $^\circ\text{C}$	$V_{GS} = 10\text{V}, I_D = 4.0\text{A}$
G_{FS}	Forward transconductance	1200	-	-	mmho	$V_{DS} = 25\text{V}, I_D = 2.0\text{A}$
C_{ISS}	Input capacitance	-	300	500	pF	$V_{GS} = 0\text{V}, V_{DS} = 25\text{V}, f = 1.0\text{MHz}$
C_{OSS}	Common source output capacitance	-	125	200		
C_{RSS}	Reverse transfer capacitance	-	50	65		
$t_{d(ON)}$	Turn-on time	-	10	15	ns	$V_{DD} = 25\text{V}, I_D = 2.0\text{A}, R_{GEN} = 10\Omega$
t_r	Rise time	-	10	15		
$t_{d(OFF)}$	Turn-off time	-	50	65		
t_f	Fall time	-	30	50		
V_{SD}	Diode forward voltage drop	-	1.0	1.6	V	$V_{GS} = 0\text{V}, I_{SD} = 4.0\text{A}$
t_{rr}	Reverse recovery time	-	500	-	ns	$V_{GS} = 0\text{V}, I_{SD} = 1.0\text{A}$

Notes:

- All D.C. parameters 100% tested at 25°C unless otherwise stated. (Pulse test: 300 μs pulse, 2% duty cycle.)
- All A.C. parameters sample tested.

Switching Waveforms and Test Circuit

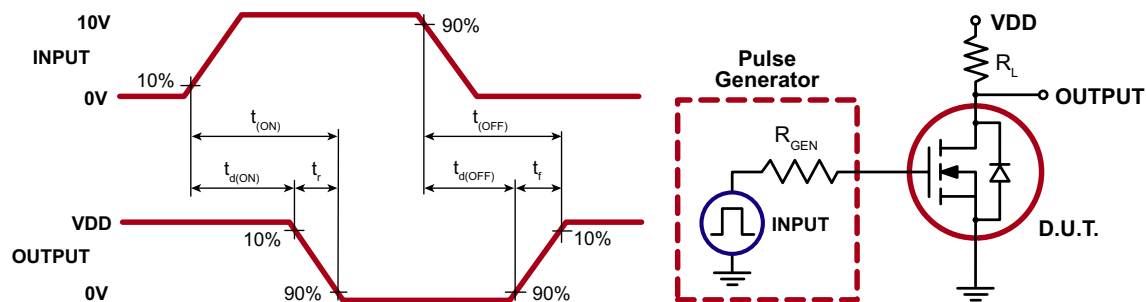

Typical Performance Curves

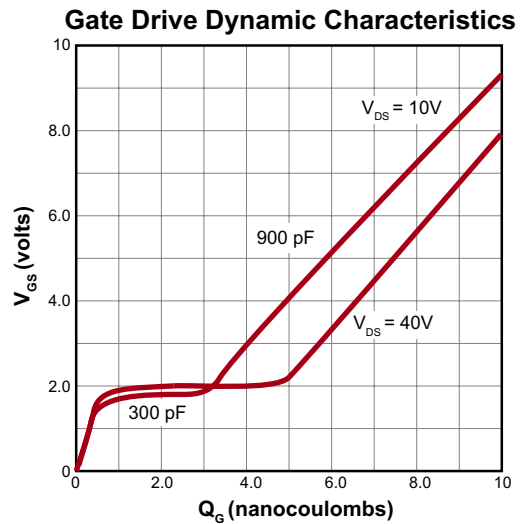
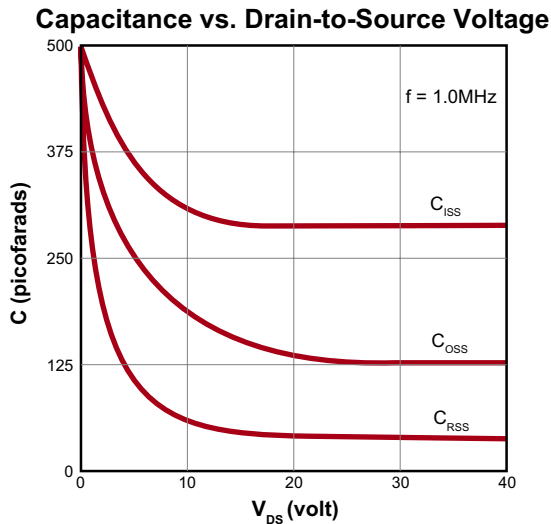
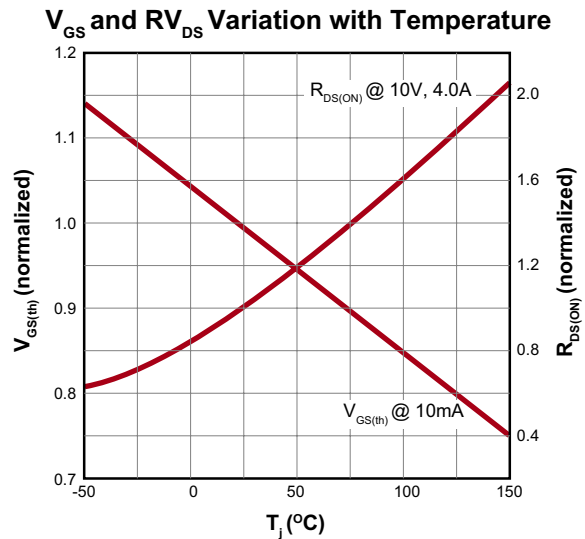
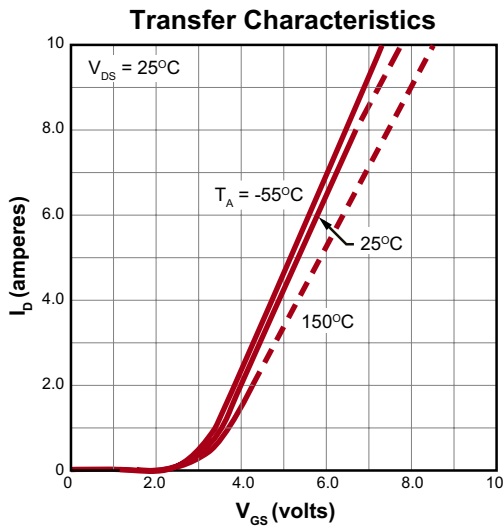
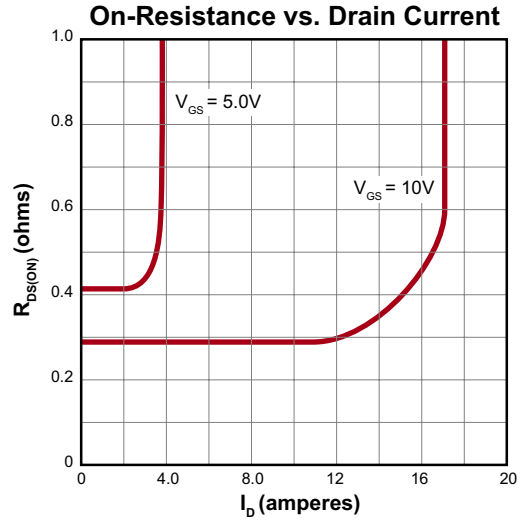
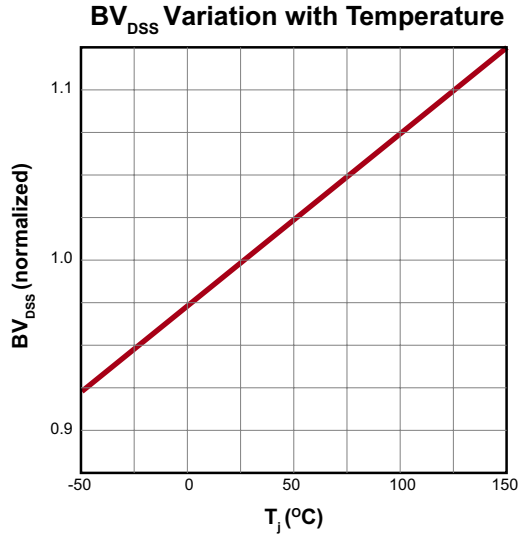

Typical Performance Curves (cont.)

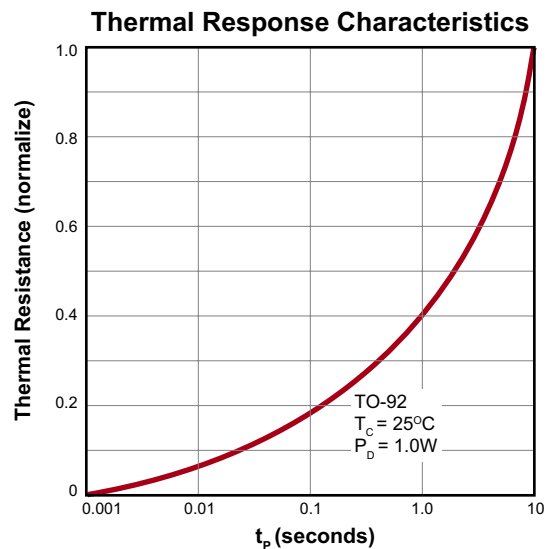
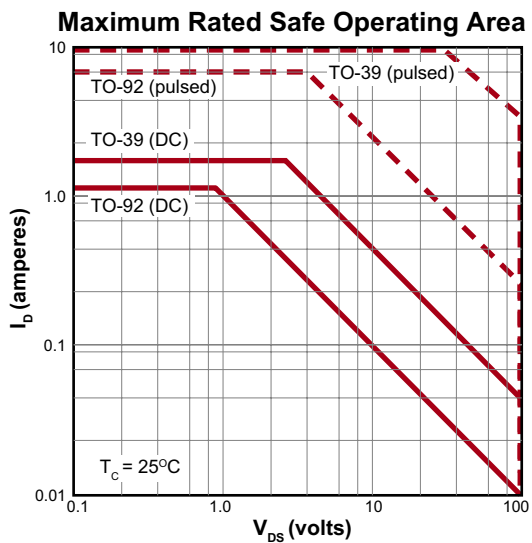
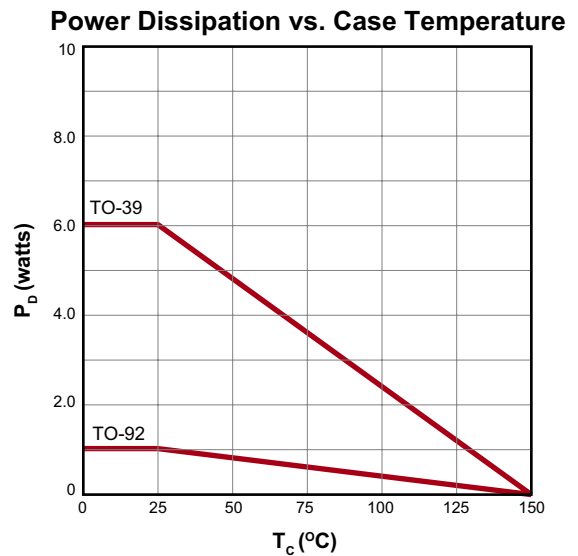
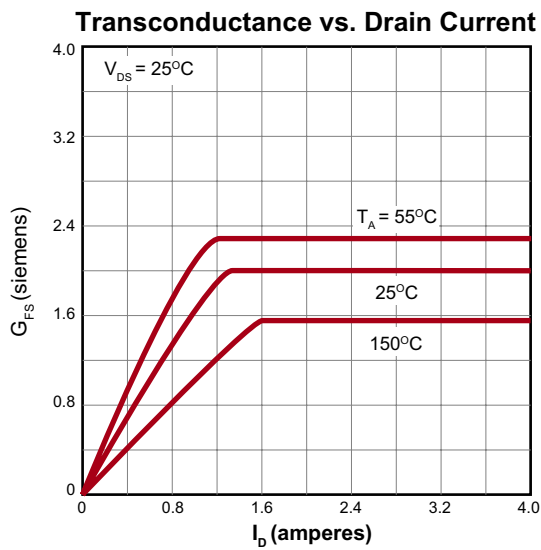
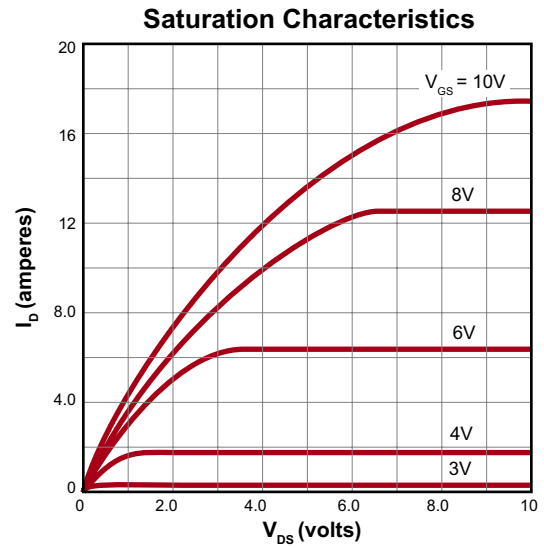
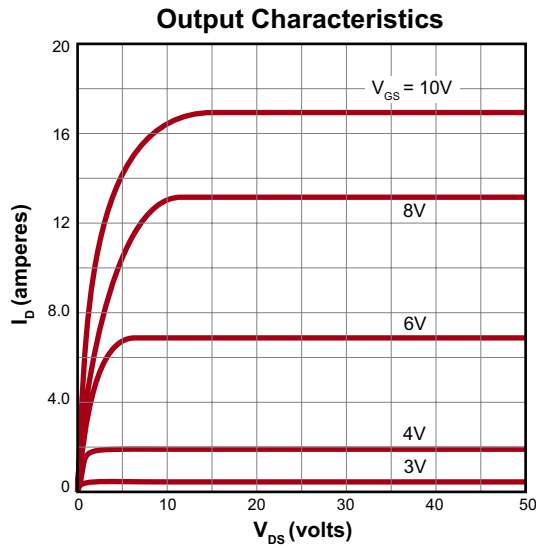

3-Lead TO-39 Package Outline (N2)

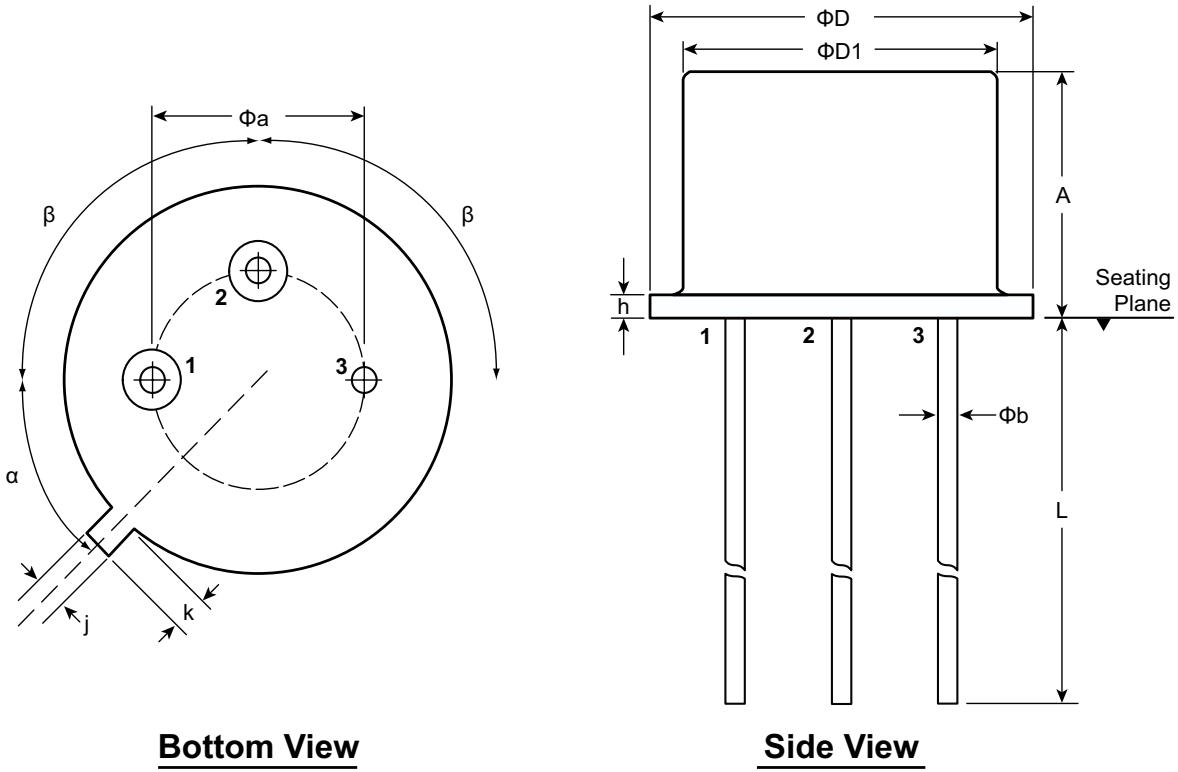

Symbol	α	β	A	ϕ_a	ϕ_b	ϕ_D	ϕ_{D1}	h	j	k	L	
Dimension (inches)	MIN	45° NOM	90° NOM	.240	.190	.016	.350	.315	.009	.028	.029	.500
	NOM			-	-	-	-	-	-	-	-	-
	MAX			.260	.210	.021	.370	.335	.125	.034	.040	.560*

JEDEC Registration TO-39.

* This dimension is not specified in the JEDEC drawing.

Drawings not to scale.

Supertex Doc. #: DSPD-3TO39N2, Version B052009.

3-Lead TO-92 Package Outline (N3)

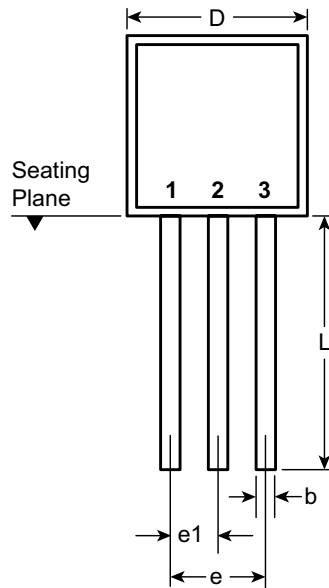

Front View

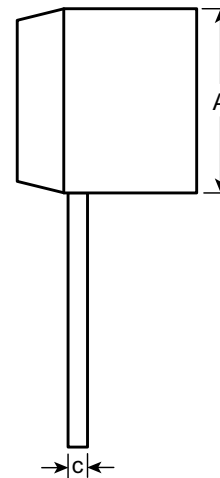

Side View

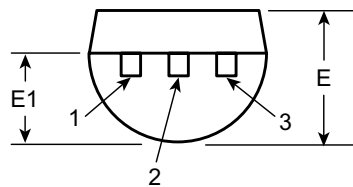

Bottom View

Symbol	A	b	c	D	E	E1	e	e1	L	
Dimensions (inches)	MIN	.170	.014 [†]	.014 [†]	.175	.125	.080	.095	.045	.500
	NOM	-	-	-	-	-	-	-	-	-
	MAX	.210	.022 [†]	.022 [†]	.205	.165	.105	.105	.055	.610*

JEDEC Registration TO-92.

* This dimension is not specified in the JEDEC drawing.

† This dimension differs from the JEDEC drawing.

Drawings not to scale.

Supertex Doc.#: DSPD-3TO92N3, Version E041009.

(The package drawing(s) in this data sheet may not reflect the most current specifications. For the latest package outline information go to <http://www.supertex.com/packaging.html>.)

Supertex inc. does not recommend the use of its products in life support applications, and will not knowingly sell them for use in such applications unless it receives an adequate "product liability indemnification insurance agreement." **Supertex inc.** does not assume responsibility for use of devices described, and limits its liability to the replacement of the devices determined defective due to workmanship. No responsibility is assumed for possible omissions and inaccuracies. Circuitry and specifications are subject to change without notice. For the latest product specifications refer to the **Supertex inc.** (website: <http://www.supertex.com>)