

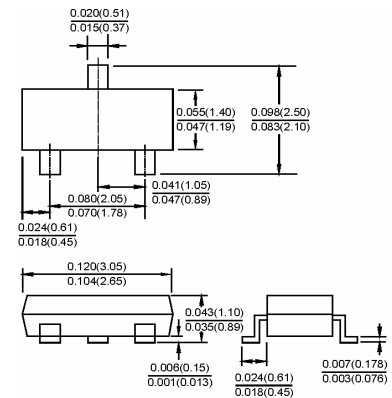

1. BASE
2. EMITTER
3. COLLECTOR



Features

- ✧ Excellent h_{FE} linearity.
- ✧ Compliments the 2SC2412

MARKING : FQ, FR, FS

Dimensions in inches and (millimeters)

MAXIMUM RATINGS ($T_A=25^\circ\text{C}$ unless otherwise noted)

Symbol	Parameter	Value	Units
V_{CBO}	Collector-Base Voltage	-60	V
V_{CEO}	Collector-Emitter Voltage	-50	V
V_{EBO}	Emitter-Base Voltage	-6	V
I_C	Collector Current -Continuous	150	mA
P_C	Collector Power Dissipation	200	mW
T_J	Junction Temperature	150	$^\circ\text{C}$
T_{stg}	Storage Temperature	-55-150	$^\circ\text{C}$

ELECTRICAL CHARACTERISTICS ($T_{amb}=25^\circ\text{C}$ unless otherwise specified)

Parameter	Symbol	Test conditions	MIN	TYP	MAX	UNIT
Collector-base breakdown voltage	$V_{(BR)CBO}$	$I_C=-50\mu\text{A}, I_E=0$	-60			V
Collector-emitter breakdown voltage	$V_{(BR)CEO}$	$I_C=-1\text{mA}, I_B=0$	-50			V
Emitter-base breakdown voltage	$V_{(BR)EBO}$	$I_E=-50\mu\text{A}, I_C=0$	-6			V
Collector cut-off current	I_{CBO}	$V_{CB}=-60\text{V}, I_E=0$			-0.1	μA
Emitter cut-off current	I_{EBO}	$V_{EB}=-6\text{V}, I_C=0$			-0.1	μA
DC current gain	h_{FE}	$V_{CE}=-6\text{V}, I_C=-1\text{mA}$	120		560	
Collector-emitter saturation voltage	$V_{CE(sat)}$	$I_C=-50\text{mA}, I_B=-5\text{mA}$			-0.5	V
Transition frequency	f_T	$V_{CE}=-12\text{V}, I_C=-2\text{mA}, f=30\text{MHz}$		140		MHz
Collector output capacitance	C_{ob}	$V_{CB}=-12\text{V}, I_E=0, f=1\text{MHz}$		4.0	5.0	pF

CLASSIFICATION OF h_{FE}

Rank	Q	R	S
Range	120 - 270	180 - 390	270 - 560

Typical Characteristics

●Electrical characteristic curves

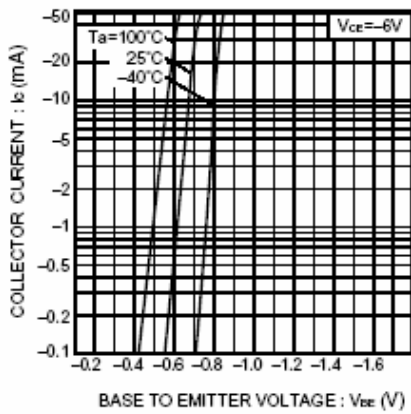

Fig.1 Grounded emitter propagation characteristics

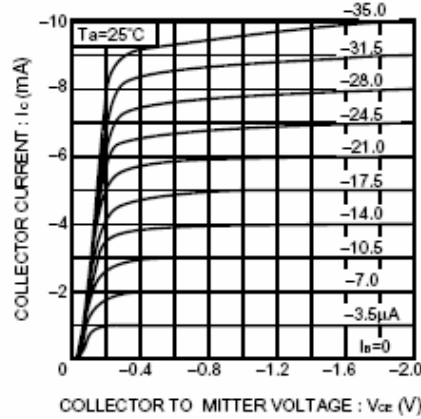

Fig.2 Grounded emitter output characteristics (I)

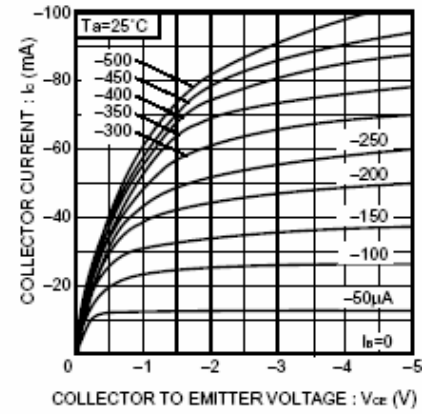

Fig.3 Grounded emitter output characteristics (II)

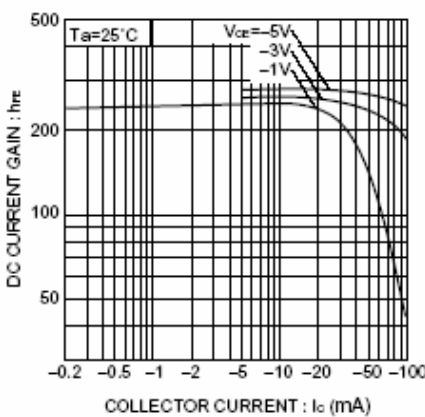

Fig.4 DC current gain vs. collector current (I)

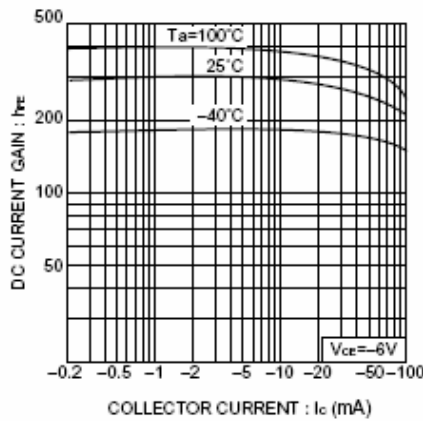

Fig.5 DC current gain vs. collector current (II)

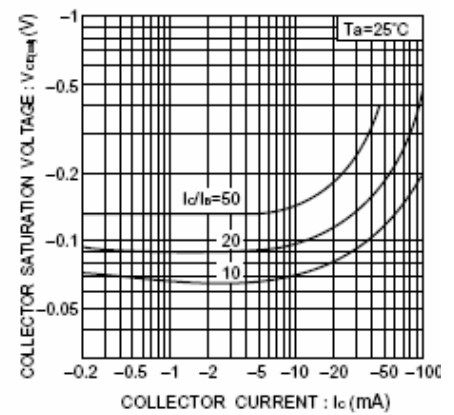

Fig.6 Collector-emitter saturation voltage vs. collector current (I)

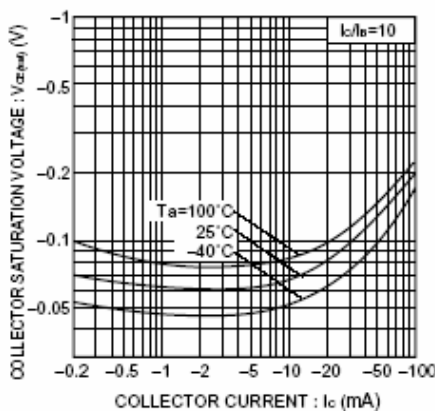

Fig.7 Collector-emitter saturation voltage vs. collector current (II)

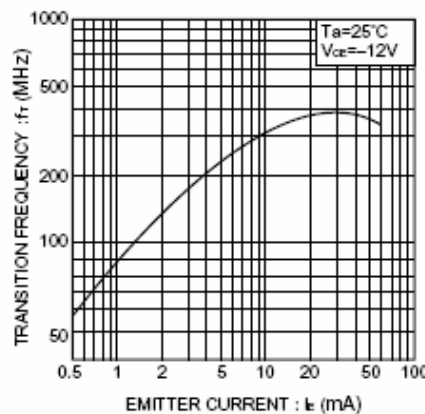

Fig.8 Gain bandwidth product vs. emitter current

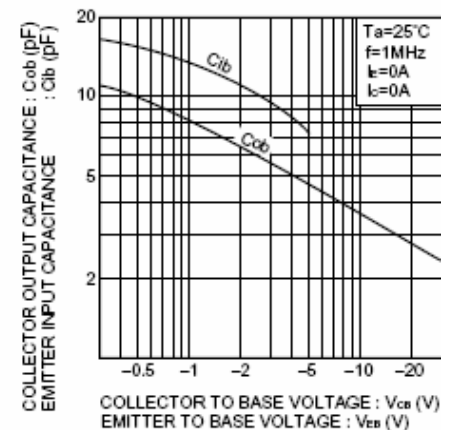

Fig.9 Collector output capacitance vs. collector-base voltage
Emitter input capacitance vs. emitter-base voltage