

IRLH5030PbF

HEXFET® Power MOSFET

V_{DS}	100	V
$R_{DS(on) \max}$ (@ $V_{GS} = 4.5V$)	9.9	mΩ
Q_g (typical)	44	nC
R_G (typical)	1.2	Ω
I_D (@ $T_{c(Bottom)} = 25^\circ C$)	100 Ⓒ	A

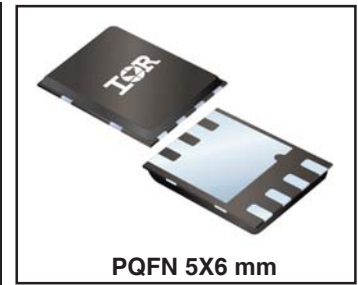
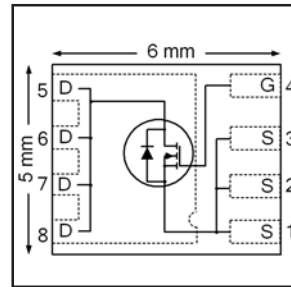

Applications

- Secondary Side Synchronous Rectification
- Inverters for DC Motors
- DC-DC Brick Applications
- Boost Converters

Features and Benefits

Features

Low $R_{DS(on)}$ ($\leq 9.0m\Omega$)
Low Thermal Resistance to PCB ($\leq 0.5^\circ C/W$)
100% Rg tested
Low Profile (≤ 0.9 mm)
Industry-Standard Pinout
Compatible with Existing Surface Mount Techniques
RoHS Compliant Containing no Lead, no Bromide and no Halogen
MSL1, Industrial Qualification

results in
⇒

Benefits

Lower Conduction Losses
Enable better thermal dissipation
Increased Reliability
Increased Power Density
Multi-Vendor Compatibility
Easier Manufacturing
Environmentally Friendlier
Increased Reliability

Orderable part number	Package Type	Standard Pack		Note
		Form	Quantity	
IRLH5030TRPBF	PQFN 5mm x 6mm	Tape and Reel	4000	
IRLH5030TR2PBF	PQFN 5mm x 6mm	Tape and Reel	1000	

Absolute Maximum Ratings

	Parameter	Max.	Units
V_{GS}	Gate-to-Source Voltage	± 16	V
$I_D @ T_A = 25^\circ C$	Continuous Drain Current, $V_{GS} @ 10V$	13	A
$I_D @ T_A = 70^\circ C$	Continuous Drain Current, $V_{GS} @ 10V$	11	
$I_D @ T_{c(Bottom)} = 25^\circ C$	Continuous Drain Current, $V_{GS} @ 10V$ Ⓒ	100	
$I_D @ T_{c(Bottom)} = 100^\circ C$	Continuous Drain Current, $V_{GS} @ 10V$	70	
I_{DM}	Pulsed Drain Current ①	400	
$P_D @ T_A = 25^\circ C$	Power Dissipation ⑤	3.6	W
$P_D @ T_{c(Bottom)} = 25^\circ C$	Power Dissipation ⑤	250	
	Linear Derating Factor ⑤	0.029	W/°C
T_J T_{STG}	Operating Junction and Storage Temperature Range	-55 to +150	°C

Notes ① through ⑥ are on page 8

Static @ T_J = 25°C (unless otherwise specified)

	Parameter	Min.	Typ.	Max.	Units	Conditions
BV _{DSS}	Drain-to-Source Breakdown Voltage	100	—	—	V	V _{GS} = 0V, I _D = 250μA
ΔBV _{DSS} /ΔT _J	Breakdown Voltage Temp. Coefficient	—	0.10	—	V/°C	Reference to 25°C, I _D = 1mA
R _{DS(on)}	Static Drain-to-Source On-Resistance	—	7.2	9.0	mΩ	V _{GS} = 10V, I _D = 50A ③
		—	7.9	9.9		V _{GS} = 4.5V, I _D = 50A ③
V _{GS(th)}	Gate Threshold Voltage	1.0	—	2.5	V	V _{DS} = V _{GS} , I _D = 150μA
ΔV _{GS(th)}	Gate Threshold Voltage Coefficient	—	-5.9	—	mV/°C	
I _{DSS}	Drain-to-Source Leakage Current	—	—	20	μA	V _{DS} = 100V, V _{GS} = 0V
		—	—	250		V _{DS} = 100V, V _{GS} = 0V, T _J = 125°C
I _{GSS}	Gate-to-Source Forward Leakage	—	—	100	nA	V _{GS} = 16V
	Gate-to-Source Reverse Leakage	—	—	-100		V _{GS} = -16V
g _{fs}	Forward Transconductance	160	—	—	S	V _{DS} = 50V, I _D = 50A
Q _g	Total Gate Charge	—	94	—	nC	V _{GS} = 10V, V _{DS} = 50V, I _D = 50A
Q _g	Total Gate Charge	—	44	66	nC	V _{DS} = 50V V _{GS} = 4.5V I _D = 50A See Fig.17 & 18
Q _{gs1}	Pre-V _{th} Gate-to-Source Charge	—	7.7	—		
Q _{gs2}	Post-V _{th} Gate-to-Source Charge	—	4.0	—		
Q _{gd}	Gate-to-Drain Charge	—	22	—		
Q _{godr}	Gate Charge Overdrive	—	10.3	—		
Q _{sw}	Switch Charge (Q _{gs2} + Q _{gd})	—	26	—		
Q _{oss}	Output Charge	—	20	—	nC	V _{DS} = 16V, V _{GS} = 0V
R _G	Gate Resistance	—	1.2	—	Ω	
t _{d(on)}	Turn-On Delay Time	—	21	—	ns	V _{DD} = 50V, V _{GS} = 4.5V I _D = 50A R _G = 1.8Ω See Fig.15
t _r	Rise Time	—	72	—		
t _{d(off)}	Turn-Off Delay Time	—	41	—		
t _f	Fall Time	—	41	—		
C _{iss}	Input Capacitance	—	5185	—	pF	V _{GS} = 0V V _{DS} = 50V f = 1.0MHz
C _{oss}	Output Capacitance	—	300	—		
C _{rss}	Reverse Transfer Capacitance	—	150	—		

Avalanche Characteristics

	Parameter	Typ.	Max.	Units
E _{AS}	Single Pulse Avalanche Energy ②	—	230	mJ
I _{AR}	Avalanche Current ①	—	50	A

Diode Characteristics

	Parameter	Min.	Typ.	Max.	Units	Conditions
I _S	Continuous Source Current (Body Diode)	—	—	100	A	MOSFET symbol showing the integral reverse p-n junction diode.
I _{SM}	Pulsed Source Current (Body Diode) ①	—	—	400		
V _{SD}	Diode Forward Voltage	—	—	1.0	V	T _J = 25°C, I _S = 50A, V _{GS} = 0V ③
t _{rr}	Reverse Recovery Time	—	32	48	ns	T _J = 25°C, I _F = 50A, V _{DD} = 50V
Q _{rr}	Reverse Recovery Charge	—	190	285	nC	di/dt = 500A/μs ③
t _{on}	Forward Turn-On Time	Time is dominated by parasitic Inductance				

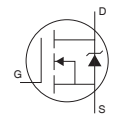

Thermal Resistance

	Parameter	Typ.	Max.	Units
R _{θJC} (Bottom)	Junction-to-Case ④	—	0.5	°C/W
R _{θJC} (Top)	Junction-to-Case ④	—	15	
R _{θJA}	Junction-to-Ambient ⑤	—	35	
R _{θJA} (<10s)	Junction-to-Ambient ⑤	—	33	

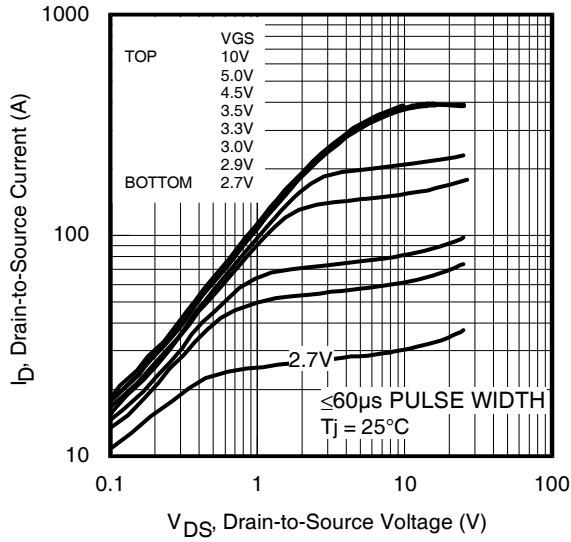

Fig 1. Typical Output Characteristics

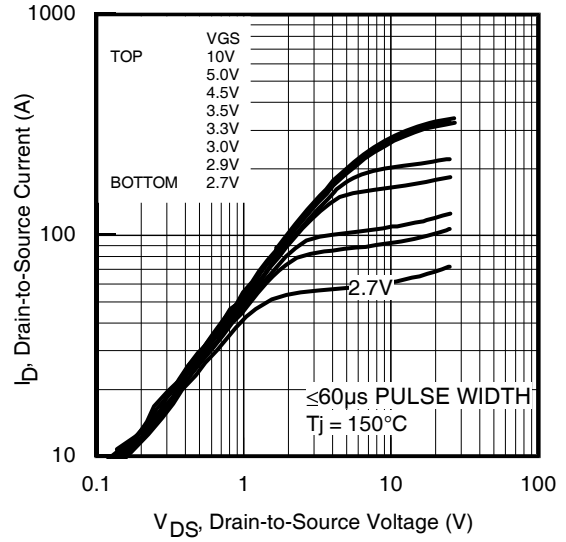

Fig 2. Typical Output Characteristics

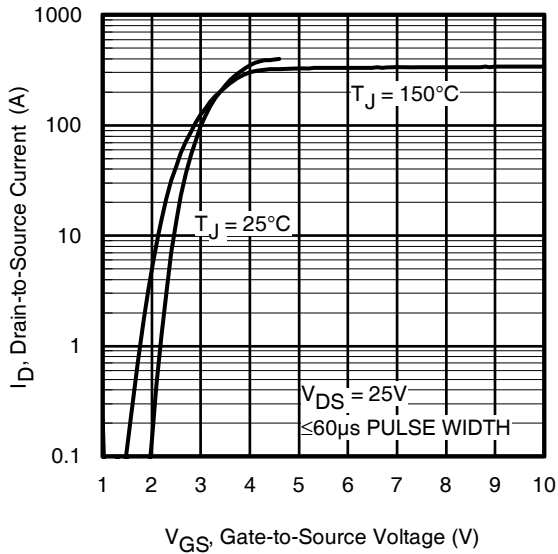

Fig 3. Typical Transfer Characteristics

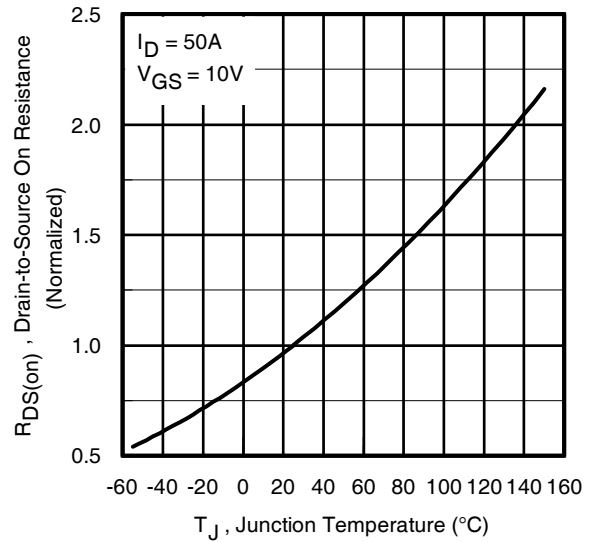

Fig 4. Normalized On-Resistance vs. Temperature

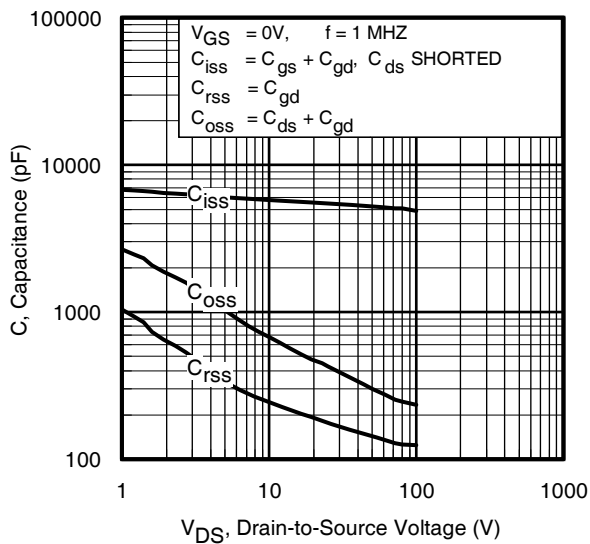

Fig 5. Typical Capacitance vs. Drain-to-Source Voltage
www.irf.com

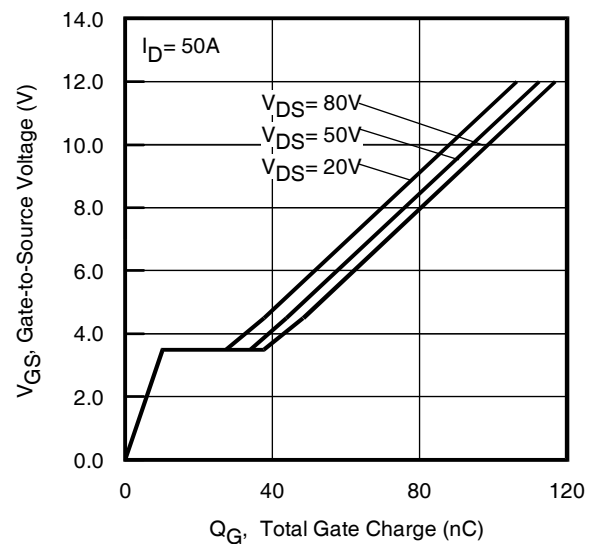

Fig 6. Typical Gate Charge vs. Gate-to-Source Voltage

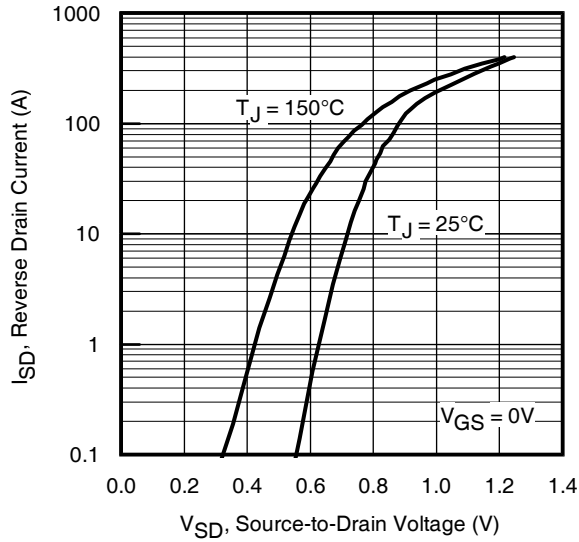

Fig 7. Typical Source-Drain Diode Forward Voltage

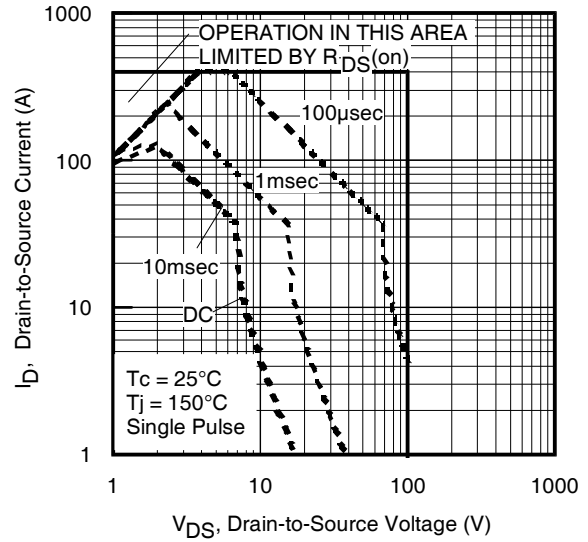

Fig 8. Maximum Safe Operating Area

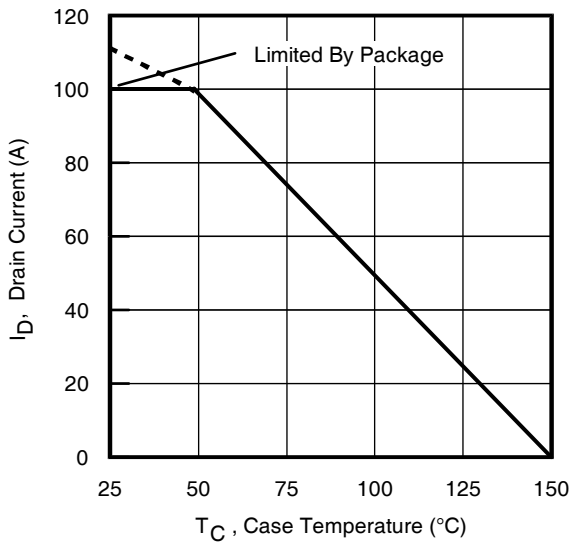

Fig 9. Maximum Drain Current vs. Case (Bottom) Temperature

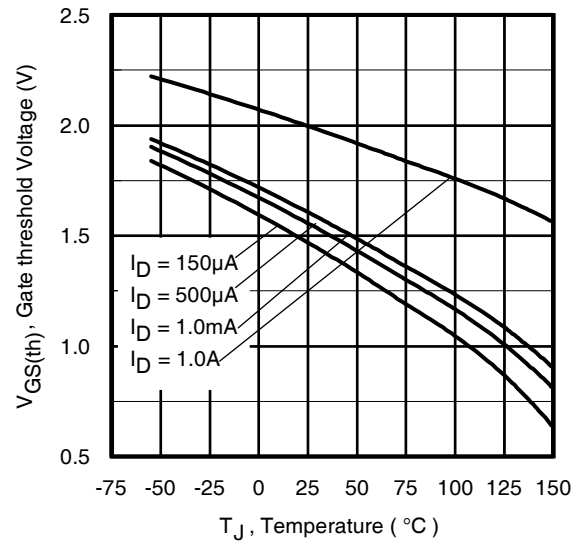

Fig 10. Threshold Voltage vs. Temperature

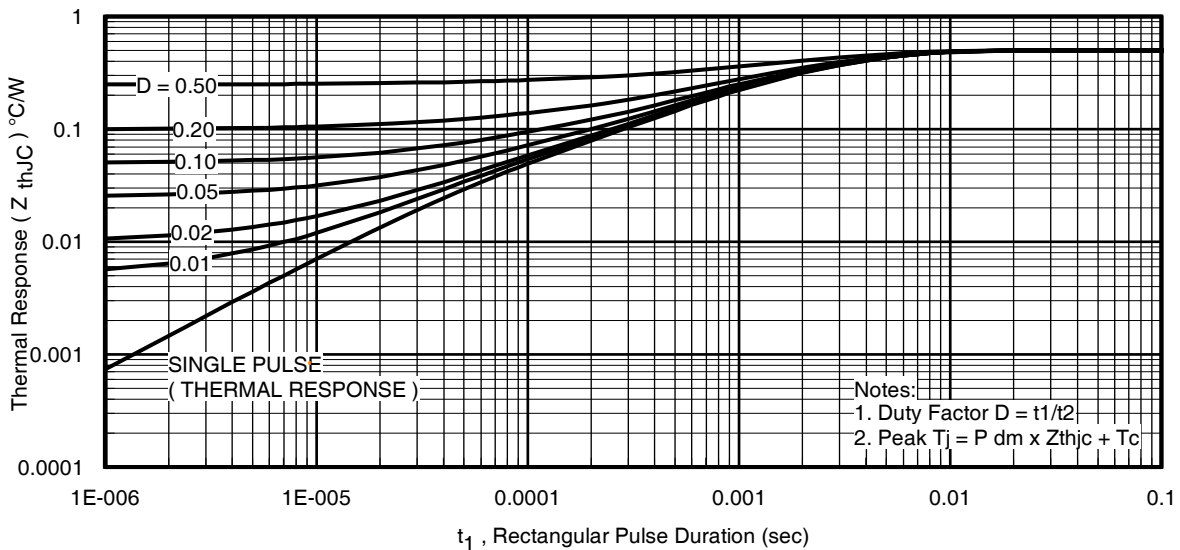

Fig 11. Maximum Effective Transient Thermal Impedance, Junction-to-Case (Bottom)

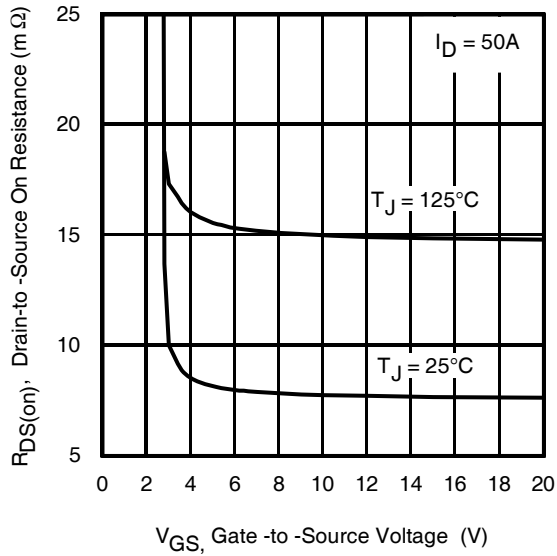

Fig 12. On-Resistance vs. Gate Voltage

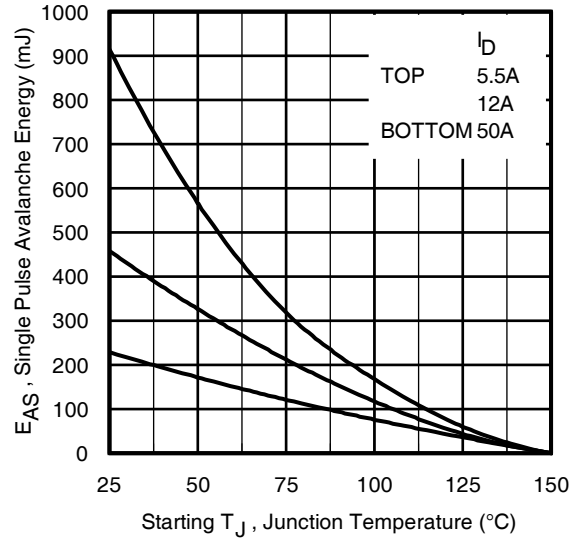

Fig 13. Maximum Avalanche Energy vs. Drain Current

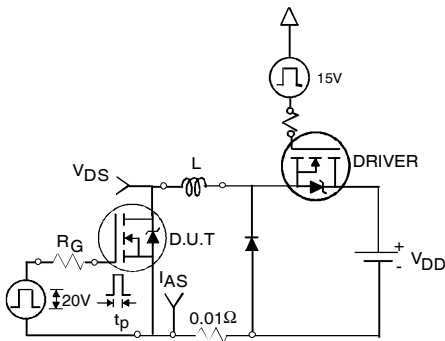

Fig 14a. Unclamped Inductive Test Circuit

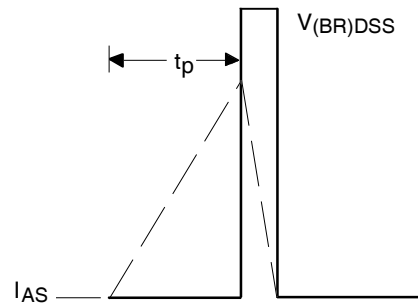

Fig 14b. Unclamped Inductive Waveforms

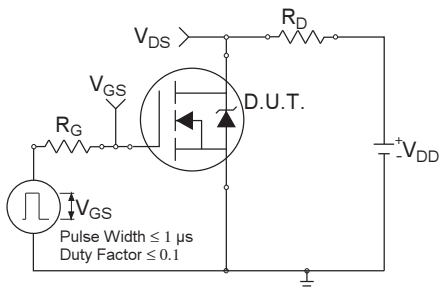

Fig 15a. Switching Time Test Circuit

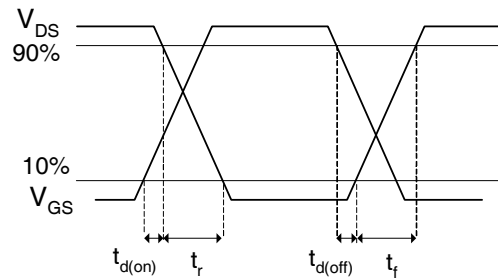

Fig 15b. Switching Time Waveforms

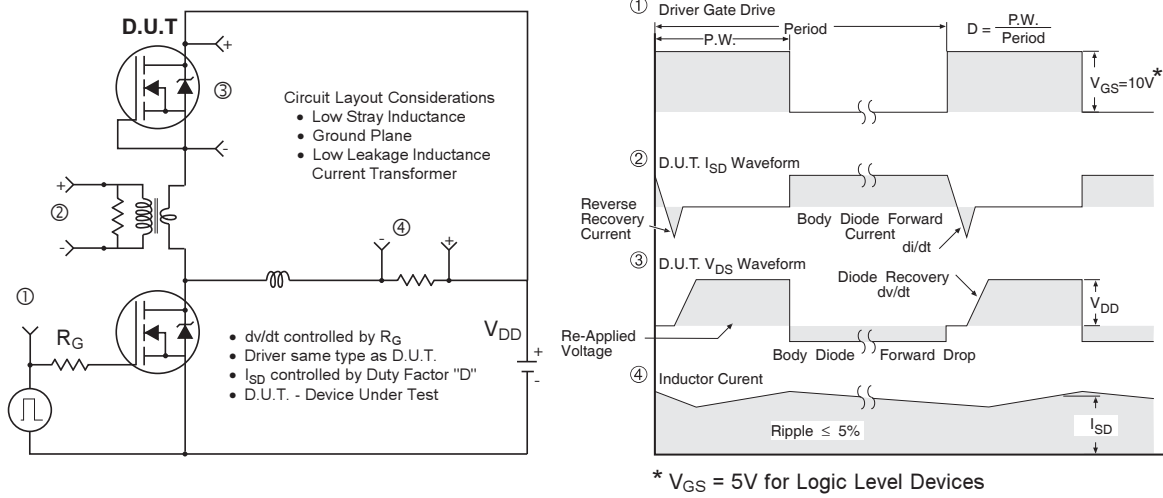

Fig 16. Peak Diode Recovery dv/dt Test Circuit for N-Channel HEXFET[®] Power MOSFETs

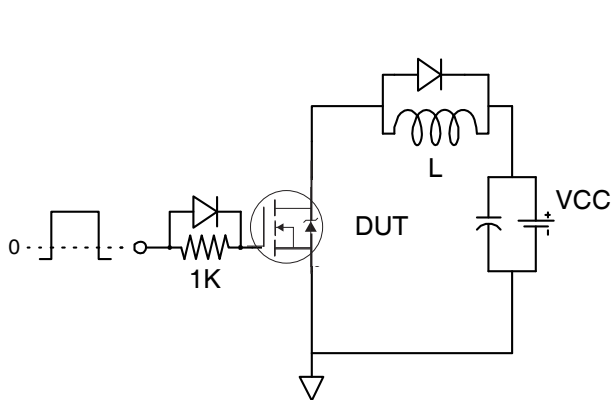

Fig 17. Gate Charge Test Circuit

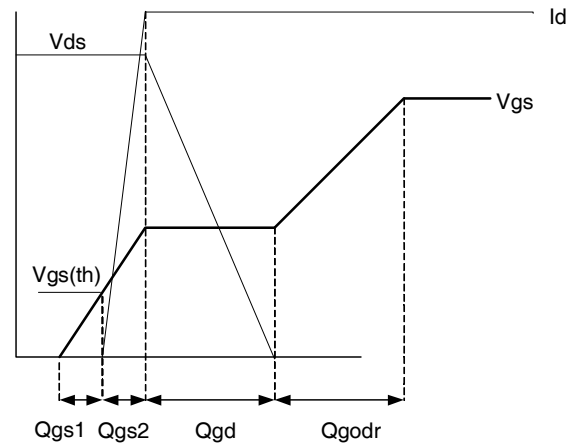
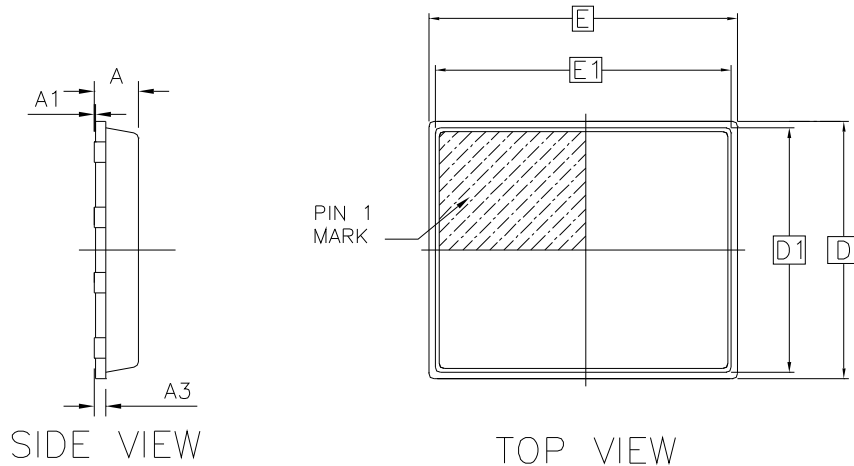
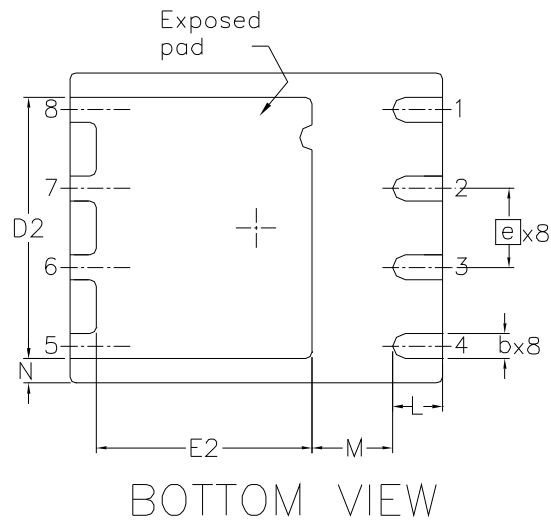

Fig 18. Gate Charge Waveform

PQFN 5x6 Outline "B" Package Details



OUTLINE PQFN 5x6B			
DIM SYMBOL	MIN	NOM	MAX
A	0.80	0.83	0.90
A1	0	0.020	0.05
A3		0.20	REF
b	0.35	0.40	0.47
D		5.00	BSC
D1		4.75	BSC
D2	4.10	4.21	4.30
e		1.27	BSC
E		6.00	BSC
E1		5.75	BSC
E2	3.38	3.48	3.58
L	0.70	0.80	0.90
M		1.30	REF
N		0.40	REF



For footprint and stencil design recommendations, please refer to application note AN-1154 at <http://www.irf.com/technical-info/appnotes/an-1154.pdf>

PQFN 5x6 Outline "B" Part Marking

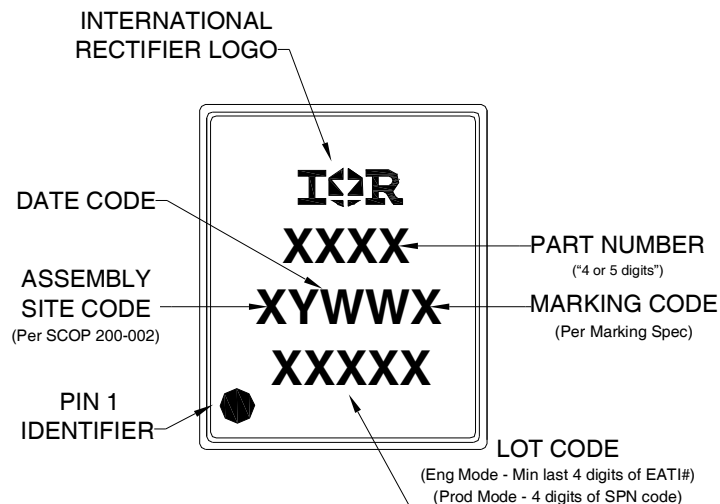

Note: For the most current drawing please refer to IR website at: <http://www.irf.com/package/>

PQFN 5x6 Outline "B" Tape and Reel

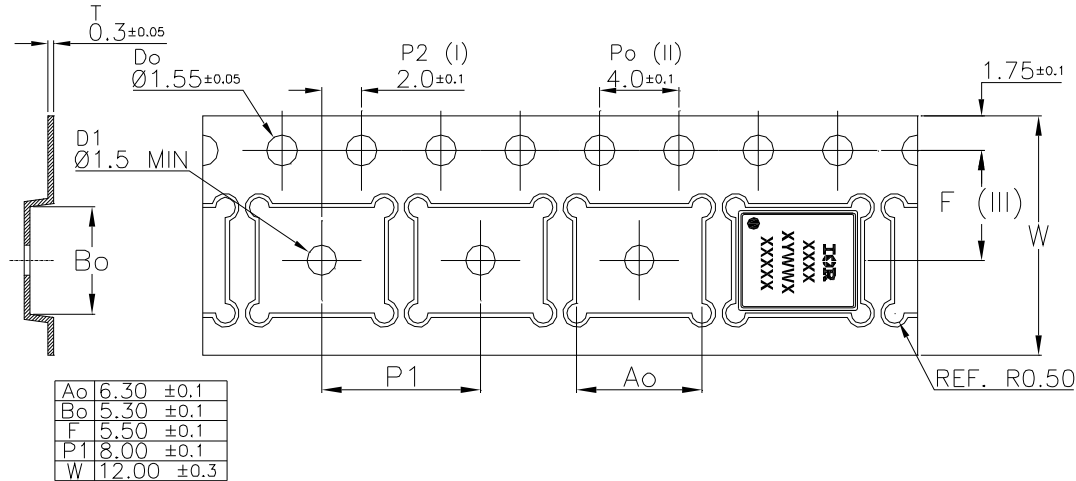

Qualification information†

Qualification level	Industrial ^{††} (per JEDEC JESD47F ^{†††} guidelines)	
Moisture Sensitivity Level	PQFN 5mm x 6mm	MSL1 (per JEDEC J-STD-020D ^{†††})
RoHS compliant	Yes	

† Qualification standards can be found at International Rectifier's web site

<http://www.irf.com/product-info/reliability>

†† Higher qualification ratings may be available should the user have such requirements.

Please contact your International Rectifier sales representative for further information:

<http://www.irf.com/whoto-call/salesrep/>

††† Applicable version of JEDEC standard at the time of product release.

Notes:

- ① Repetitive rating; pulse width limited by max. junction temperature.
- ② Starting $T_J = 25^\circ\text{C}$, $L = 0.18\text{mH}$, $R_G = 25\Omega$, $I_{AS} = 50\text{A}$.
- ③ Pulse width $\leq 400\mu\text{s}$; duty cycle $\leq 2\%$.
- ④ R_θ is measured at T_J of approximately 90°C .
- ⑤ When mounted on 1 inch square 2 oz copper pad on 1.5x1.5 in. board of FR-4 material.
- ⑥ Calculated continuous current based on maximum allowable junction temperature. Package is limited to 100A by production test capability.

Data and specifications subject to change without notice.

International
IR Rectifier

IR WORLD HEADQUARTERS: 101 N. Sepulveda Blvd., El Segundo, California 90245, USA Tel: (310) 252-7105

TAC Fax: (310) 252-7903

Visit us at www.irf.com for sales contact information. 01/2012