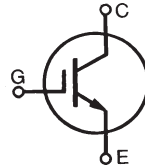

**1200V XPT™ IGBTs**  
**GenX3™**
**IXYK100N120B3**  
**IXYX100N120B3**

 Extreme Light Punch Through  
 IGBT for 5-30 kHz Switching

$$V_{CES} = 1200V$$

$$I_{C110} = 100A$$

$$V_{CE(sat)} \leq 2.6V$$

$$t_{fi(typ)} = 240ns$$

| Symbol                        | Test Conditions   | Maximum Ratings                           |            |
|-------------------------------|---|---|------------|
| $V_{CES}$                     | $T_J = 25^\circ C$ to $175^\circ C$   | 1200                                      | V          |
| $V_{CGR}$                     | $T_J = 25^\circ C$ to $175^\circ C$ , $R_{GE} = 1M\Omega$                           | 1200                                      | V          |
| $V_{GES}$                     | Continuous  | $\pm 20$                                  | V          |
| $V_{GEM}$                     | Transient   | $\pm 30$                                  | V          |
| $I_{C25}$                     | $T_C = 25^\circ C$ (Chip Capability)  | 225                                       | A          |
| $I_{LRMS}$                    | Terminal Current Limit  | 160                                       | A          |
| $I_{C110}$                    | $T_C = 110^\circ C$   | 100                                       | A          |
| $I_{CM}$                      | $T_C = 25^\circ C$ , 1ms  | 530                                       | A          |
| $I_A$                         | $T_C = 25^\circ C$  | 50  | A          |
| $E_{AS}$                      | $T_C = 25^\circ C$  | 1.2                                       | J          |
| <b>SSOA</b><br><b>(RBSOA)</b> | $V_{GE} = 15V$ , $T_{VJ} = 150^\circ C$ , $R_G = 1\Omega$<br>Clamped Inductive Load | $I_{CM} = 200$<br>@ $V_{CE} \leq V_{CES}$ | A          |
| $P_C$                         | $T_C = 25^\circ C$  | 1150                                      | W          |
| $T_J$                         |   | -55 ... +175                              | $^\circ C$ |
| $T_{JM}$                      |   | 175                                       | $^\circ C$ |
| $T_{stg}$                     |   | -55 ... +175                              | $^\circ C$ |
| $T_L$                         | Maximum Lead Temperature for Soldering  | 300                                       | $^\circ C$ |
| $T_{SOLD}$                    | 1.6 mm (0.062in.) from Case for 10s   | 260                                       | $^\circ C$ |
| $M_d$                         | Mounting Torque (TO-264)  | 1.13/10                                   | Nm/lb.in.  |
| $F_c$                         | Mounting Force (PLUS247)  | 20..120 / 4.5..27                         | N/lb.      |
| <b>Weight</b>                 | TO-264  | 10  | g          |
|                               | PLUS247   | 6   | g          |

| Symbol        | Test Conditions<br>( $T_J = 25^\circ C$ , Unless Otherwise Specified) | Characteristic Values |              |                    |
|---------------|---|-----------------------|--------------|--------------------|
|               |   | Min.                  | Typ.         | Max.               |
| $BV_{CES}$    | $I_C = 250\mu A$ , $V_{GE} = 0V$                                      | 1200                  |              | V                  |
| $V_{GE(th)}$  | $I_C = 250\mu A$ , $V_{CE} = V_{GE}$                                  | 3.0                   |              | 5.0 V              |
| $I_{CES}$     | $V_{CE} = V_{CES}$ , $V_{GE} = 0V$<br>$T_J = 150^\circ C$             |                       |              | 25 $\mu A$<br>1 mA |
| $I_{GES}$     | $V_{CE} = 0V$ , $V_{GE} = \pm 20V$                                    |                       |              | $\pm 100$ nA       |
| $V_{CE(sat)}$ | $I_C = I_{C110}$ , $V_{GE} = 15V$ , Note 1<br>$T_J = 150^\circ C$     |                       | 2.20<br>2.76 | V<br>V             |

TO-264 (IXYK)

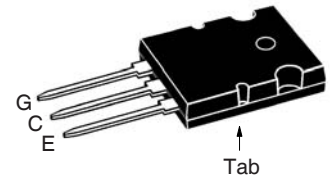

PLUS247 (IXYX)

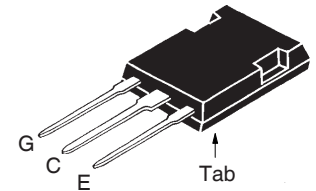
 G = Gate                      E = Emitter  
 C = Collector                Tab = Collector

**Features**

- Optimized for 5-30kHz Switching
- Square RBSOA
- Positive Thermal Coefficient of  $V_{ce(sat)}$
- Avalanche Rated
- International Standard Packages

**Advantages**

- High Power Density
- Low Gate Drive Requirement

**Applications**

- Power Inverters
- UPS
- Motor Drives
- SMPS
- PFC Circuits
- Battery Chargers
- Welding Machines
- Lamp Ballasts

| Symbol Test Conditions<br>( $T_J = 25^\circ\text{C}$ Unless Otherwise Specified) |   | Characteristic Values |      |                    |
|--|---|-----------------------|------|--------------------|
|  |   | Min.                  | Typ. | Max.               |
| $g_{fs}$   | $I_C = 60\text{A}, V_{CE} = 10\text{V}$ , Note 1  | 30                    | 52   | S                  |
| $C_{ies}$  | $V_{CE} = 25\text{V}, V_{GE} = 0\text{V}, f = 1\text{MHz}$  |                       | 6000 | pF                 |
| $C_{oes}$  |   |                       | 367  | pF                 |
| $C_{res}$  |   |                       | 127  | pF                 |
| $Q_{g(on)}$  | $I_C = I_{C110}, V_{GE} = 15\text{V}, V_{CE} = 0.5 \cdot V_{CES}$   |                       | 250  | nC                 |
| $Q_{ge}$   |   |                       | 42   | nC                 |
| $Q_{gc}$   |   |                       | 96   | nC                 |
| $t_{d(on)}$  | <b>Inductive load, <math>T_J = 25^\circ\text{C}</math></b><br>$I_C = I_{C110}, V_{GE} = 15\text{V}$<br>$V_{CE} = 0.5 \cdot V_{CES}, R_G = 1\Omega$<br>Note 2  |                       | 30   | ns                 |
| $t_{ri}$   |   |                       | 90   | ns                 |
| $E_{on}$   |   |                       | 7.7  | mJ                 |
| $t_{d(off)}$   |   |                       | 153  | ns                 |
| $t_{fi}$   |   |                       | 240  | ns                 |
| $E_{off}$  |   | 7.1                   | 11.5 | mJ                 |
| $t_{d(on)}$  | <b>Inductive load, <math>T_J = 150^\circ\text{C}</math></b><br>$I_C = I_{C110}, V_{GE} = 15\text{V}$<br>$V_{CE} = 0.5 \cdot V_{CES}, R_G = 1\Omega$<br>Note 2 |                       | 29   | ns                 |
| $t_{ri}$   |   |                       | 96   | ns                 |
| $E_{on}$   |   |                       | 11.4 | mJ                 |
| $t_{d(off)}$   |   |                       | 190  | ns                 |
| $t_{fi}$   |   |                       | 260  | ns                 |
| $E_{off}$  |   | 10.1                  | mJ   |                    |
| $R_{thJC}$   |   |                       | 0.13 | $^\circ\text{C/W}$ |
| $R_{thCS}$   |   | 0.15                  |      | $^\circ\text{C/W}$ |

**Notes:**

1. Pulse test,  $t \leq 300\mu\text{s}$ , duty cycle,  $d \leq 2\%$ .
2. Switching times & energy losses may increase for higher  $V_{CE}$  (clamp),  $T_J$  or  $R_G$ .

**PRELIMINARY TECHNICAL INFORMATION**

The product presented herein is under development. The Technical Specifications offered are derived from a subjective evaluation of the design, based upon prior knowledge and experience, and constitute a "considered reflection" of the anticipated result. IXYS reserves the right to change limits, test conditions, and dimensions without notice.

**TO-264 Outline**

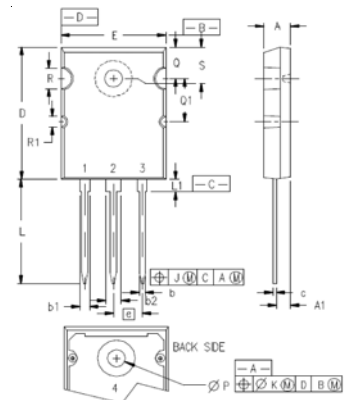

Terminals: 1 = Gate  
2,4 = Collector  
3 = Emitter

| SYM | INCHES   |       | MILLIMETERS |       |
|-----|----------|-------|-------------|-------|
|     | MIN      | MAX   | MIN         | MAX   |
| A   | .185     | .209  | 4.70        | 5.31  |
| A1  | .102     | .118  | 2.59        | 3.00  |
| b   | .037     | .055  | 0.94        | 1.40  |
| b1  | .087     | .102  | 2.21        | 2.59  |
| b2  | .110     | .126  | 2.79        | 3.20  |
| c   | .017     | .029  | 0.43        | 0.74  |
| D   | 1.007    | 1.047 | 25.58       | 26.59 |
| E   | .760     | .799  | 19.30       | 20.29 |
| e   | .215 BSC |       | 5.46 BSC    |       |
| J   | .000     | .010  | 0.00        | 0.25  |
| K   | .000     | .010  | 0.00        | 0.25  |
| L   | .779     | .842  | 19.79       | 21.39 |
| L1  | .087     | .102  | 2.21        | 2.59  |
| ØP  | .122     | .138  | 3.10        | 3.51  |
| Q   | .240     | .256  | 6.10        | 6.50  |
| Q1  | .330     | .346  | 8.38        | 8.79  |
| ØR  | .155     | .187  | 3.94        | 4.75  |
| ØR1 | .085     | .093  | 2.16        | 2.36  |
| S   | .243     | .253  | 6.17        | 6.43  |

**PLUS247™ Outline**

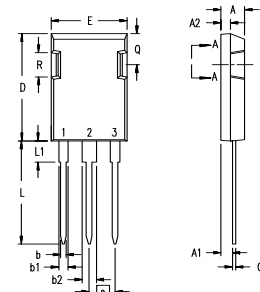

Terminals: 1 - Gate  
2 - Collector  
3 - Emitter

| Dim.           | Millimeter |       | Inches   |       |
|----------------|------------|-------|----------|-------|
|                | Min.       | Max.  | Min.     | Max.  |
| A              | 4.83       | 5.21  | .190     | .205  |
| A <sub>1</sub> | 2.29       | 2.54  | .090     | .100  |
| A <sub>2</sub> | 1.91       | 2.16  | .075     | .085  |
| b              | 1.14       | 1.40  | .045     | .055  |
| b <sub>1</sub> | 1.91       | 2.13  | .075     | .084  |
| b <sub>2</sub> | 2.92       | 3.12  | .115     | .123  |
| C              | 0.61       | 0.80  | .024     | .031  |
| D              | 20.80      | 21.34 | .819     | .840  |
| E              | 15.75      | 16.13 | .620     | .635  |
| e              | 5.45 BSC   |       | .215 BSC |       |
| L              | 19.81      | 20.32 | .780     | .800  |
| L1             | 3.81       | 4.32  | .150     | .170  |
| Q              | 5.59       | 6.20  | .220     | 0.244 |
| R              | 4.32       | 4.83  | .170     | .190  |

IXYS Reserves the Right to Change Limits, Test Conditions, and Dimensions.

|  |           |           |           |           |              |              |              |              |              |             |
|--|-----------|-----------|-----------|-----------|--------------|--------------|--------------|--------------|--------------|-------------|
| IXYS MOSFETs and IGBTs are covered by one or more of the following U.S. patents: | 4,835,592 | 4,931,844 | 5,049,961 | 5,237,481 | 6,162,665    | 6,404,065 B1 | 6,683,344    | 6,727,585    | 7,005,734 B2 | 7,157,338B2 |
|  | 4,860,072 | 5,017,508 | 5,063,307 | 5,381,025 | 6,259,123 B1 | 6,534,343    | 6,710,405 B2 | 6,759,692    | 7,063,975 B2 |             |
|  | 4,881,106 | 5,034,796 | 5,187,117 | 5,486,715 | 6,306,728 B1 | 6,583,505    | 6,710,463    | 6,771,478 B2 | 7,071,537    |             |

**Fig. 1. Output Characteristics @  $T_J = 25^\circ\text{C}$**

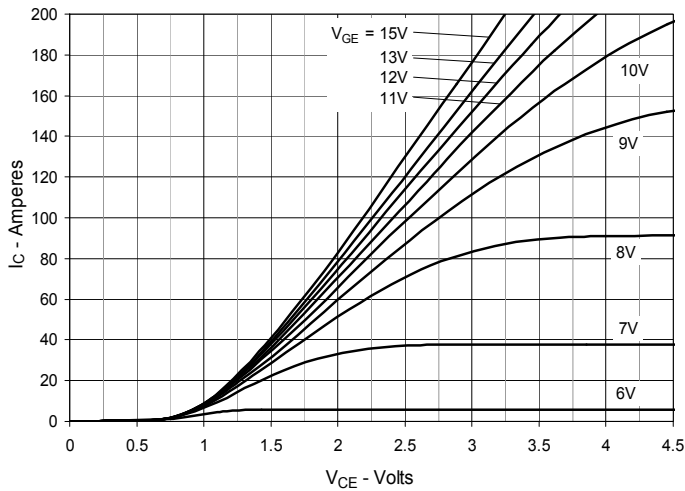

**Fig. 2. Extended Output Characteristics @  $T_J = 25^\circ\text{C}$**

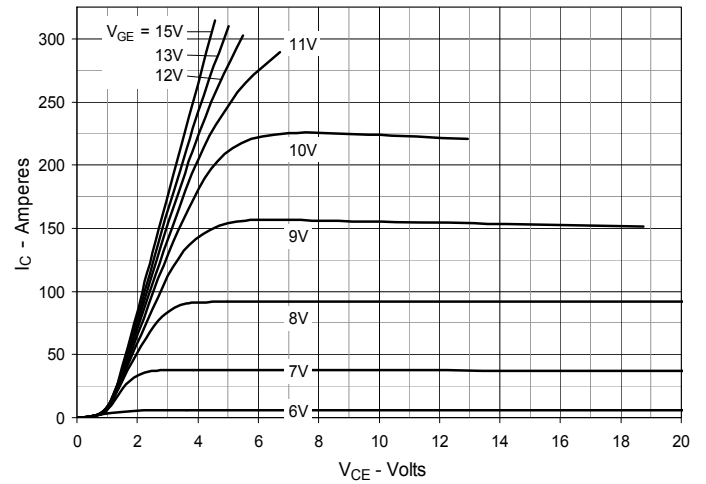

**Fig. 3. Output Characteristics @  $T_J = 150^\circ\text{C}$**

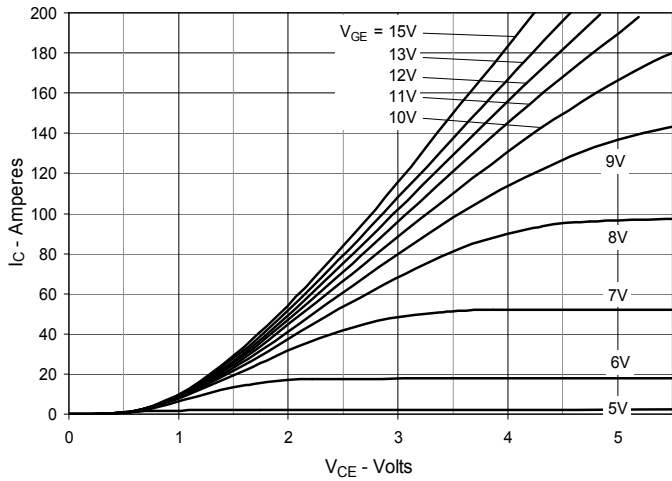

**Fig. 4. Dependence of  $V_{CE(sat)}$  on Junction Temperature**

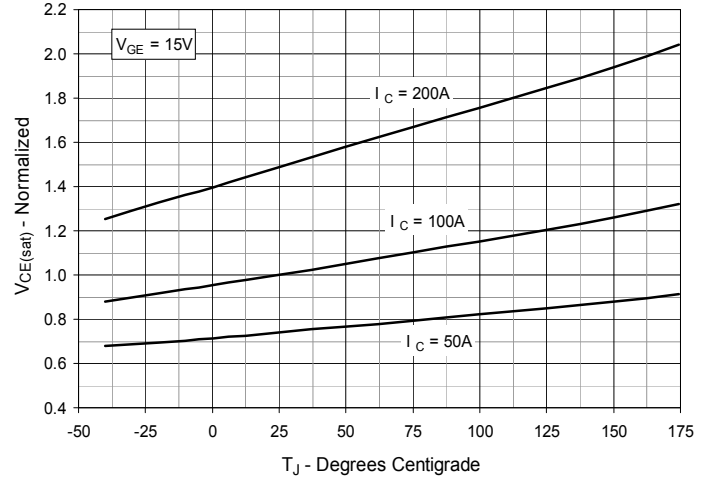

**Fig. 5. Collector-to-Emitter Voltage vs. Gate-to-Emitter Voltage**

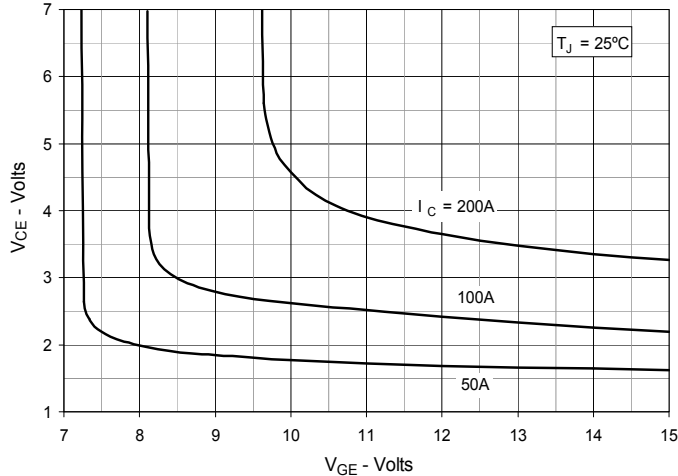

**Fig. 6. Input Admittance**

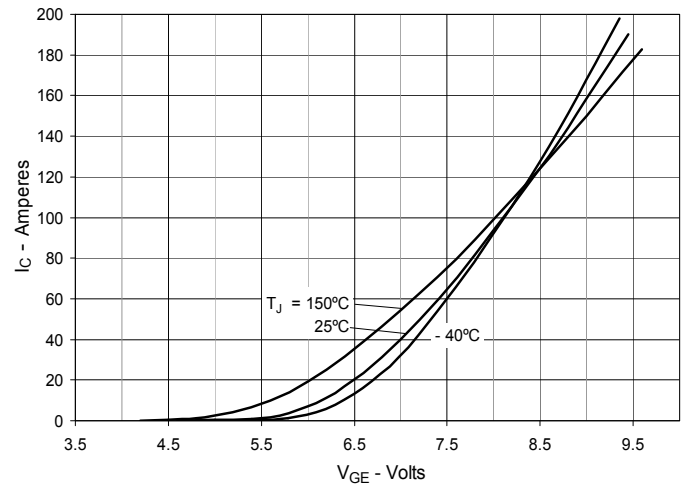

**Fig. 7. Transconductance**

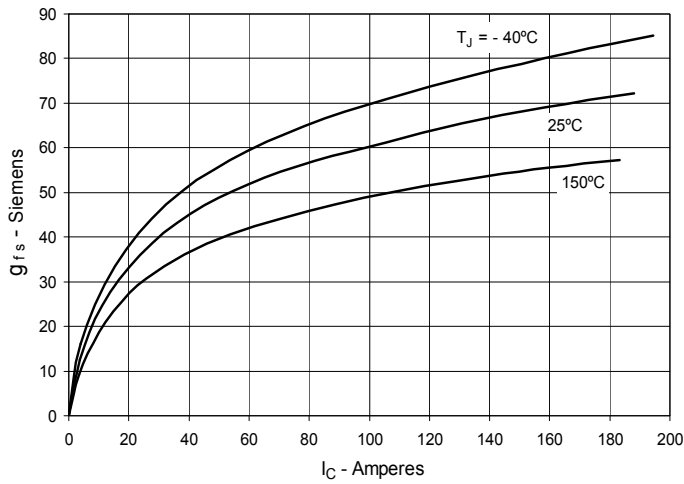

**Fig. 8. Gate Charge**

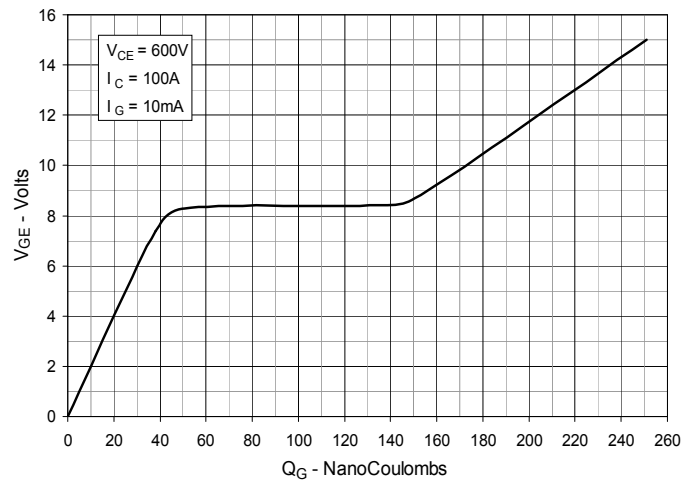

**Fig. 9. Capacitance**

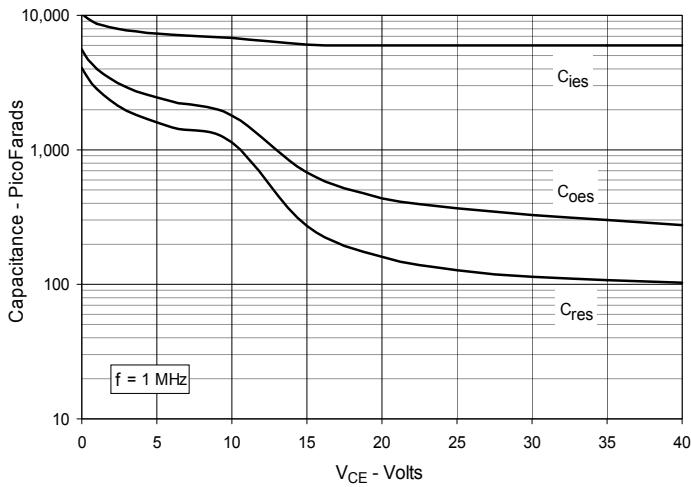

**Fig. 10. Reverse-Bias Safe Operating Area**

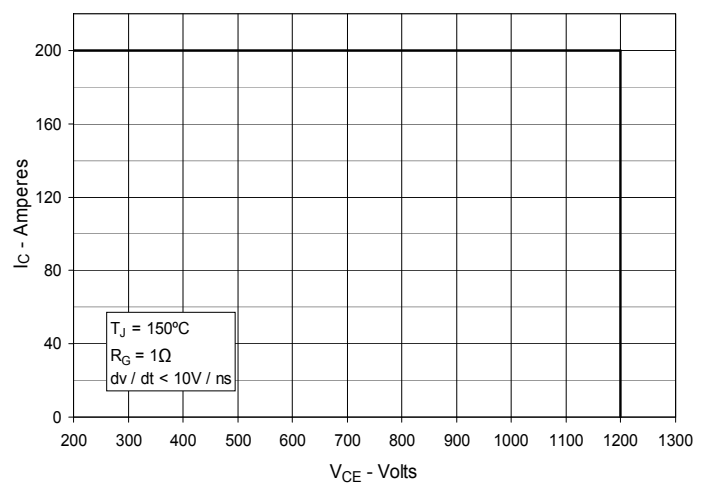

**Fig. 11. Maximum Transient Thermal Impedance**

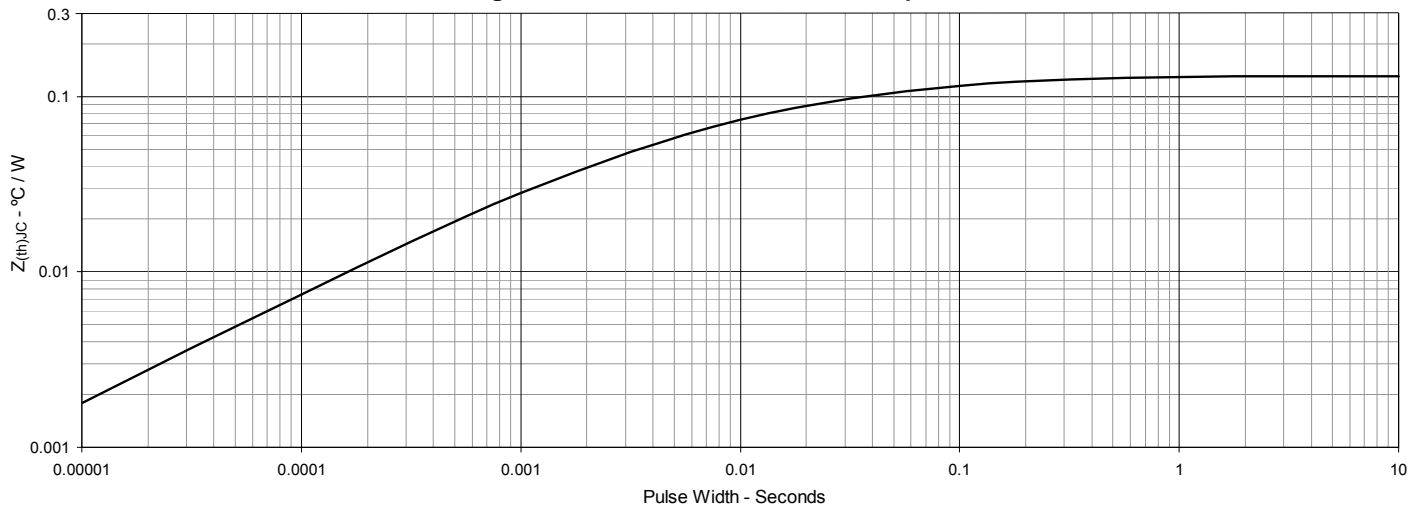

**Fig. 12. Inductive Switching Energy Loss vs. Gate Resistance**

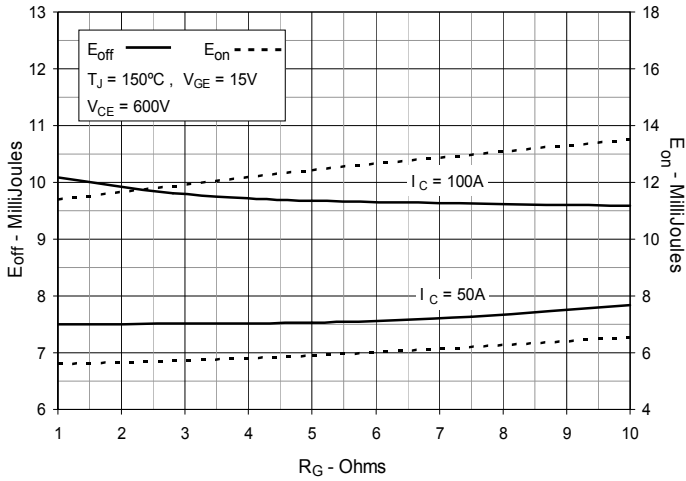

**Fig. 13. Inductive Switching Energy Loss vs. Collector Current**

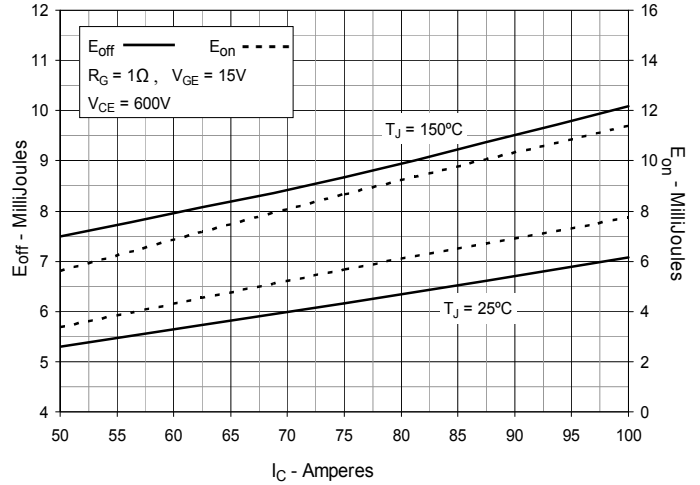

**Fig. 14. Inductive Switching Energy Loss vs. Junction Temperature**

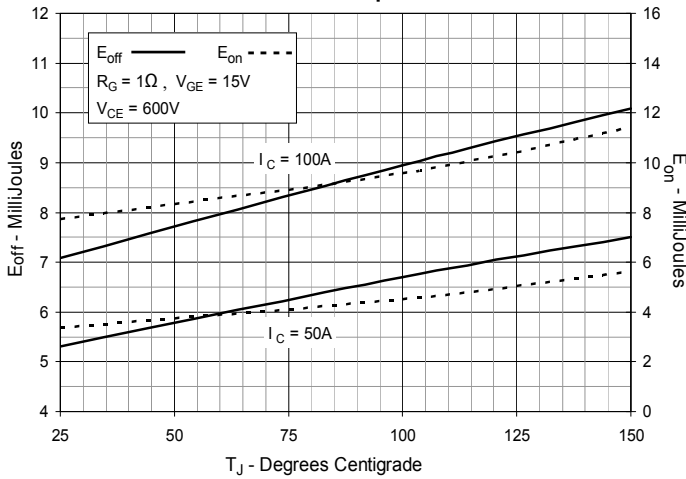

**Fig. 15. Inductive Turn-off Switching Times vs. Gate Resistance**

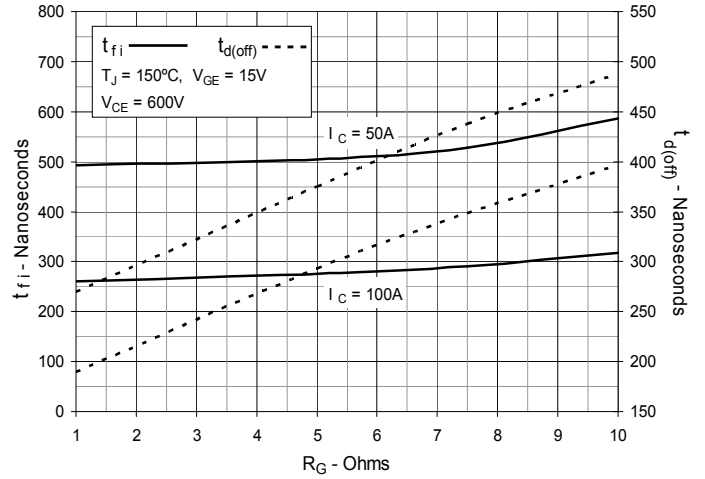

**Fig. 16. Inductive Turn-off Switching Times vs. Collector Current**

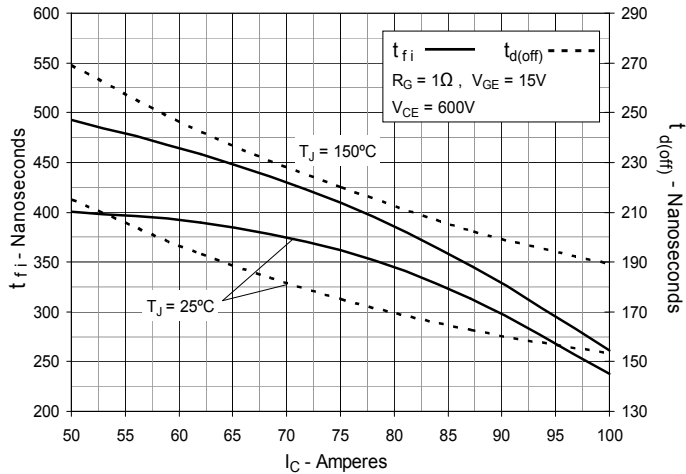

**Fig. 17. Inductive Turn-off Switching Times vs. Junction Temperature**

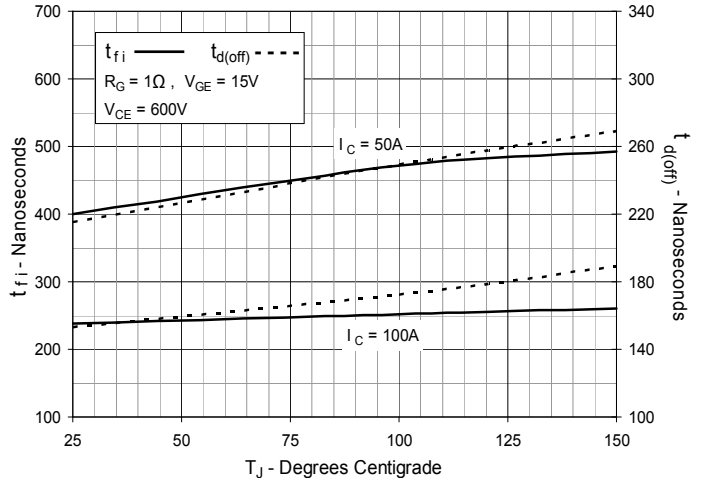

**Fig. 18. Inductive Turn-on Switching Times vs. Gate Resistance**

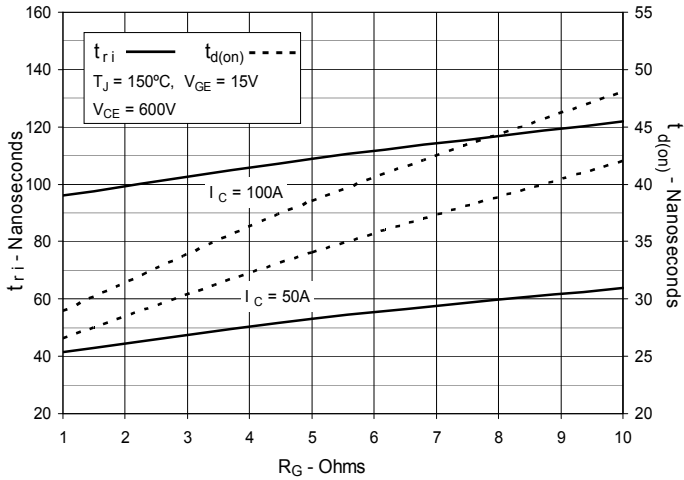

**Fig. 19. Inductive Turn-on Switching Times vs. Collector Current**

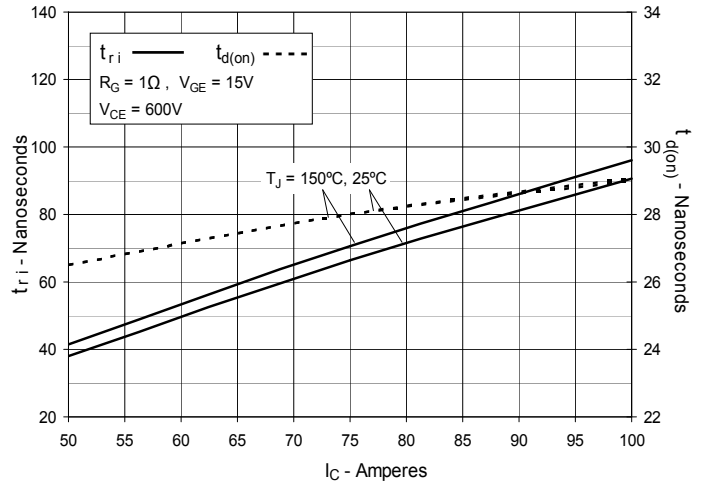

**Fig. 20. Inductive Turn-on Switching Times vs. Junction Temperature**

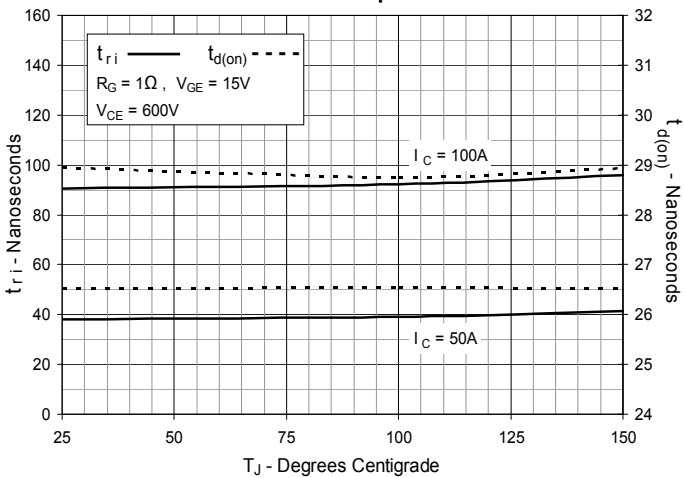



---

Disclaimer Notice - Information furnished is believed to be accurate and reliable. However, users should independently evaluate the suitability of and test each product selected for their own applications. Littelfuse products are not designed for, and may not be used in, all applications. Read complete Disclaimer Notice at [www.littelfuse.com/disclaimer-electronics](http://www.littelfuse.com/disclaimer-electronics).