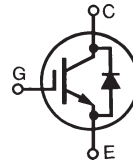


**XPT™ 650V IGBT**  
**GenX3™**
**IXYH40N65C3**

 Extreme Light Punch Through  
 IGBT for 20-60 kHz Switching


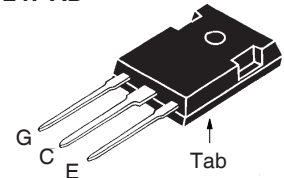
$$V_{CES} = 650V$$

$$I_{C110} = 40A$$

$$V_{CE(sat)} \leq 2.35V$$

$$t_{fi(typ)} = 20ns$$

| Symbol                        | Test Conditions   | Maximum Ratings                          |            |
|-------------------------------|---|--|------------|
| $V_{CES}$                     | $T_J = 25^\circ C$ to $175^\circ C$   | 650                                      | V          |
| $V_{CGR}$                     | $T_J = 25^\circ C$ to $175^\circ C$ , $R_{GE} = 1M\Omega$                                   | 650                                      | V          |
| $V_{GES}$                     | Continuous  | $\pm 20$                                 | V          |
| $V_{GEM}$                     | Transient   | $\pm 30$                                 | V          |
| $I_{C25}$                     | $T_C = 25^\circ C$  | 80                                       | A          |
| $I_{C110}$                    | $T_C = 110^\circ C$   | 40                                       | A          |
| $I_{CM}$                      | $T_C = 25^\circ C$ , 1ms  | 180                                      | A          |
| $I_A$                         | $T_C = 25^\circ C$  | 20                                       | A          |
| $E_{AS}$                      | $T_C = 25^\circ C$  | 300                                      | mJ         |
| <b>SSOA</b><br><b>(RBSOA)</b> | $V_{GE} = 15V$ , $T_{VJ} = 150^\circ C$ , $R_G = 10\Omega$<br>Clamped Inductive Load        | $I_{CM} = 80$<br>@ $V_{CE} \leq V_{CES}$ | A          |
| $t_{sc}$<br><b>(SCSOA)</b>    | $V_{GE} = 15V$ , $V_{CE} = 360V$ , $T_J = 150^\circ C$<br>$R_G = 82\Omega$ , Non Repetitive | 5  | $\mu s$    |
| $P_C$                         | $T_C = 25^\circ C$  | 300                                      | W          |
| $T_J$                         |   | -55 ... +175                             | $^\circ C$ |
| $T_{JM}$                      |   | 175                                      | $^\circ C$ |
| $T_{stg}$                     |   | -55 ... +175                             | $^\circ C$ |
| $T_L$                         | Maximum Lead Temperature for Soldering  | 300                                      | $^\circ C$ |
| $T_{SOLD}$                    | 1.6 mm (0.062in.) from Case for 10s   | 260                                      | $^\circ C$ |
| $M_d$                         | Mounting Torque   | 1.13/10                                  | Nm/lb.in   |
| <b>Weight</b>                 |   | 6  | g          |

**TO-247 AD**


G = Gate      C = Collector  
E = Emitter    Tab = Collector

**Features**

- Optimized for 20-60kHz Switching
- Square RBSOA
- Avalanche Rated
- Short Circuit Capability
- International Standard Package

**Advantages**

- High Power Density
- Extremely Rugged
- Low Gate Drive Requirement

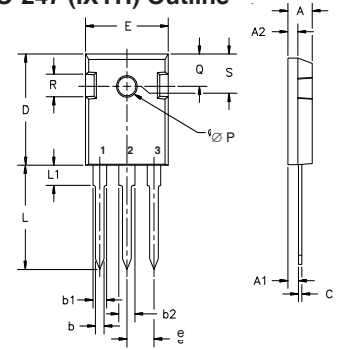
**Applications**

- Power Inverters
- UPS
- Motor Drives
- SMPS
- PFC Circuits
- Battery Chargers
- Welding Machines
- Lamp Ballasts
- High Frequency Power Inverters

| Symbol        | Test Conditions<br>( $T_J = 25^\circ C$ , Unless Otherwise Specified) | Characteristic Values |            |                           |
|---------------|---|-----------------------|------------|---------------------------|
|               |   | Min.                  | Typ.       | Max.                      |
| $BV_{CES}$    | $I_C = 250\mu A$ , $V_{GE} = 0V$                                      | 650                   |            | V                         |
| $V_{GE(th)}$  | $I_C = 250\mu A$ , $V_{CE} = V_{GE}$                                  | 3.5                   |            | 6.0 V                     |
| $I_{CES}$     | $V_{CE} = V_{CES}$ , $V_{GE} = 0V$<br>$T_J = 150^\circ C$             |                       |            | 10 $\mu A$<br>500 $\mu A$ |
| $I_{GES}$     | $V_{CE} = 0V$ , $V_{GE} = \pm 20V$                                    |                       |            | $\pm 100$ nA              |
| $V_{CE(sat)}$ | $I_C = 40A$ , $V_{GE} = 15V$ , Note 1<br>$T_J = 150^\circ C$          |                       | 2.0<br>2.4 | 2.35 V<br>V               |

| Symbol Test Conditions<br>( $T_J = 25^\circ\text{C}$ Unless Otherwise Specified) |  | Characteristic Values |      |                           |
|--|--|-----------------------|------|---------------------------|
|  |  | Min.                  | Typ. | Max.                      |
| $g_{fs}$   | $I_C = 40\text{A}, V_{CE} = 10\text{V}, \text{Note 1}$   | 16                    | 26   | S                         |
| $C_{ies}$  | $V_{CE} = 25\text{V}, V_{GE} = 0\text{V}, f = 1\text{MHz}$   |                       | 1950 | pF                        |
| $C_{oes}$  |  |                       | 118  | pF                        |
| $C_{res}$  |  |                       | 40   | pF                        |
| $Q_{g(on)}$  | $I_C = 40\text{A}, V_{GE} = 15\text{V}, V_{CE} = 0.5 \cdot V_{CES}$  |                       | 66   | nC                        |
| $Q_{ge}$   |  |                       | 13   | nC                        |
| $Q_{gc}$   |  |                       | 32   | nC                        |
| $t_{d(on)}$  | <b>Inductive load, <math>T_J = 25^\circ\text{C}</math></b><br>$I_C = 30\text{A}, V_{GE} = 15\text{V}$<br>$V_{CE} = 400\text{V}, R_G = 10\Omega$<br>Note 2  |                       | 23   | ns                        |
| $t_{ri}$   |  |                       | 40   | ns                        |
| $E_{on}$   |  |                       | 0.83 | mJ                        |
| $t_{d(off)}$   |  |                       | 110  | ns                        |
| $t_{fi}$   |  |                       | 20   | ns                        |
| $E_{off}$  |  |                       | 0.36 | 0.65 mJ                   |
| $t_{d(on)}$  | <b>Inductive load, <math>T_J = 150^\circ\text{C}</math></b><br>$I_C = 30\text{A}, V_{GE} = 15\text{V}$<br>$V_{CE} = 400\text{V}, R_G = 10\Omega$<br>Note 2 |                       | 24   | ns                        |
| $t_{ri}$   |  |                       | 40   | ns                        |
| $E_{on}$   |  |                       | 1.60 | mJ                        |
| $t_{d(off)}$   |  |                       | 130  | ns                        |
| $t_{fi}$   |  |                       | 30   | ns                        |
| $E_{off}$  |  |                       | 0.53 | mJ                        |
| $R_{thJC}$   |  |                       | 0.50 | $^\circ\text{C}/\text{W}$ |
| $R_{thCS}$   |  | 0.21                  |      | $^\circ\text{C}/\text{W}$ |

TO-247 (IXYH) Outline



Terminals: 1 - Gate 2 - Collector  
3 - Emitted

| Dim.           | Millimeter |       | Inches |       |
|----------------|------------|-------|--------|-------|
|                | Min.       | Max.  | Min.   | Max.  |
| A              | 4.7        | 5.3   | .185   | .209  |
| A <sub>1</sub> | 2.2        | 2.54  | .087   | .102  |
| A <sub>2</sub> | 2.2        | 2.6   | .059   | .098  |
| b              | 1.0        | 1.4   | .040   | .055  |
| b <sub>1</sub> | 1.65       | 2.13  | .065   | .084  |
| b <sub>2</sub> | 2.87       | 3.12  | .113   | .123  |
| C              | .4         | .8    | .016   | .031  |
| D              | 20.80      | 21.46 | .819   | .845  |
| E              | 15.75      | 16.26 | .610   | .640  |
| e              | 5.20       | 5.72  | 0.205  | 0.225 |
| L              | 19.81      | 20.32 | .780   | .800  |
| L1             |            | 4.50  |        | .177  |
| ∅P             | 3.55       | 3.65  | .140   | .144  |
| Q              | 5.89       | 6.40  | 0.232  | 0.252 |
| R              | 4.32       | 5.49  | .170   | .216  |
| S              | 6.15       | BSC   | .242   | BSC   |

Notes:

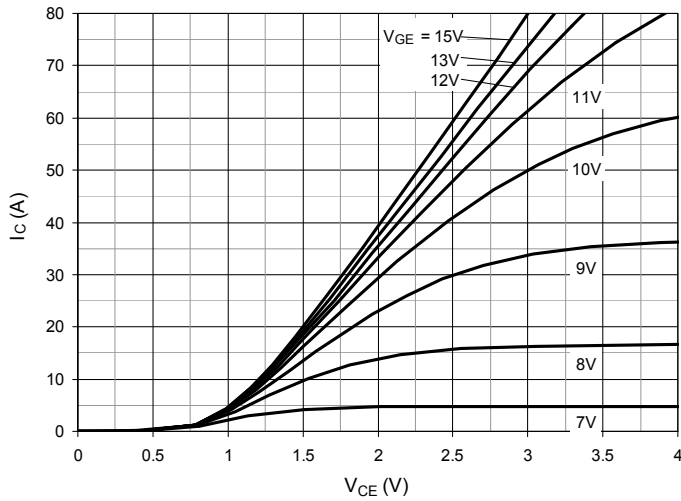
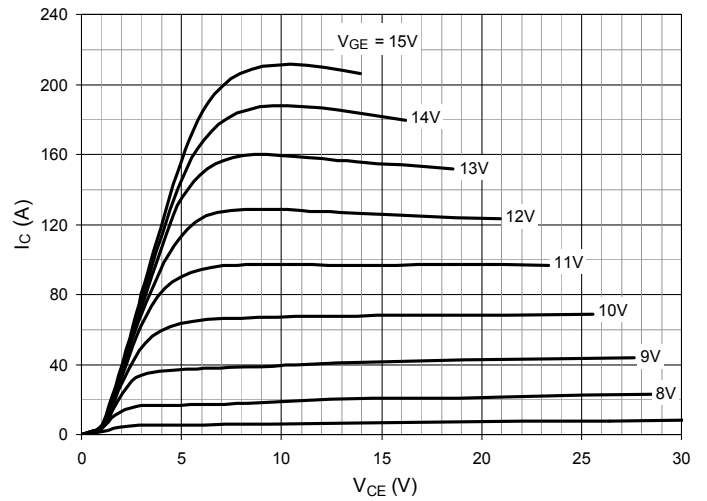
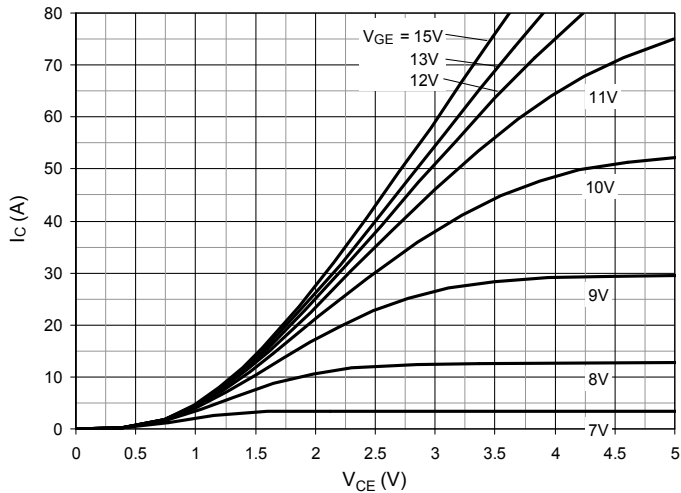
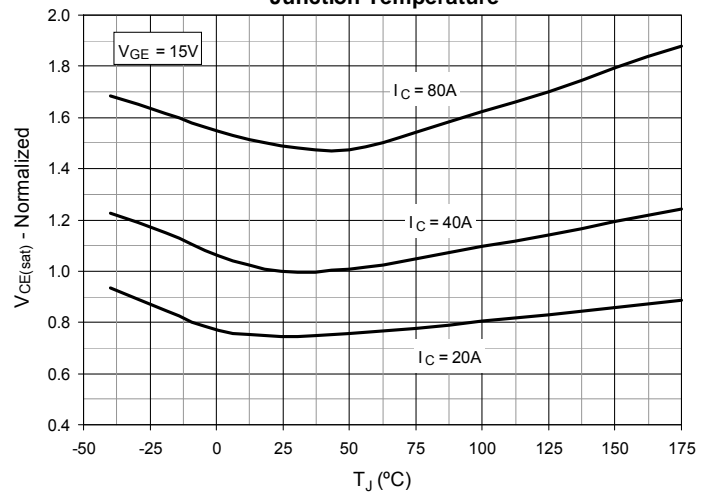
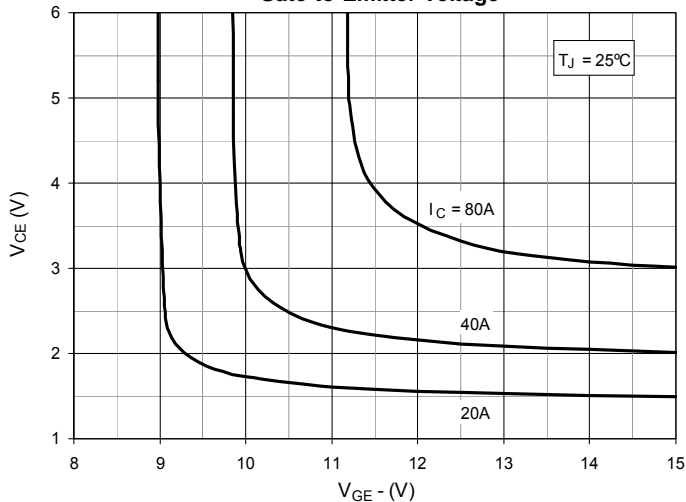
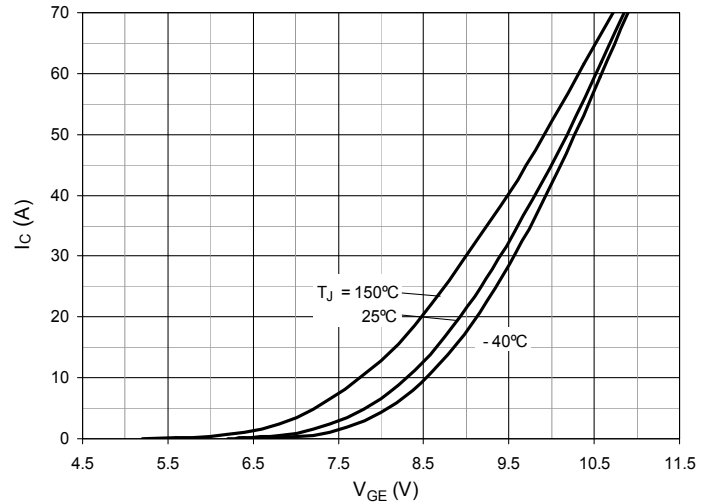
1. Pulse test,  $t \leq 300\mu\text{s}$ , duty cycle,  $d \leq 2\%$ .
2. Switching times & energy losses may increase for higher  $V_{CE}$  (clamp),  $T_J$  or  $R_G$ .

**PRELIMINARY TECHNICAL INFORMATION**

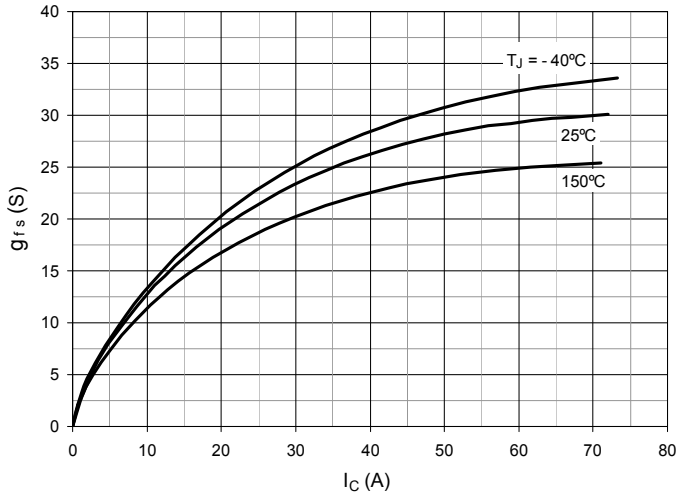
The product presented herein is under development. The Technical Specifications offered are derived from a subjective evaluation of the design, based upon prior knowledge and experience, and constitute a "considered reflection" of the anticipated result. IXYS reserves the right to change limits, test conditions, and dimensions without notice.

IXYS Reserves the Right to Change Limits, Test Conditions, and Dimensions.

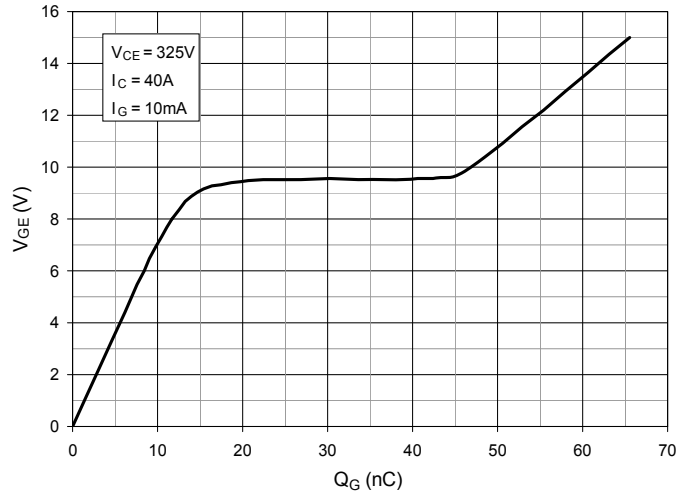
|  |           |           |           |           |              |              |              |              |              |             |
|--|-----------|-----------|-----------|-----------|--------------|--------------|--------------|--------------|--------------|-------------|
| IXYS MOSFETs and IGBTs are covered by one or more of the following U.S. patents: | 4,835,592 | 4,931,844 | 5,049,961 | 5,237,481 | 6,162,665    | 6,404,065 B1 | 6,683,344    | 6,727,585    | 7,005,734 B2 | 7,157,338B2 |
|  | 4,860,072 | 5,017,508 | 5,063,307 | 5,381,025 | 6,259,123 B1 | 6,534,343    | 6,710,405 B2 | 6,759,692    | 7,063,975 B2 |             |
|  | 4,881,106 | 5,034,796 | 5,187,117 | 5,486,715 | 6,306,728 B1 | 6,583,505    | 6,710,463    | 6,771,478 B2 | 7,071,537    |             |

**Fig. 1. Output Characteristics @  $T_J = 25^\circ\text{C}$** 

**Fig. 2. Extended Output Characteristics @  $T_J = 25^\circ\text{C}$** 

**Fig. 3. Output Characteristics @  $T_J = 150^\circ\text{C}$** 

**Fig. 4. Dependence of  $V_{CE(sat)}$  on Junction Temperature**

**Fig. 5. Collector-to-Emitter Voltage vs. Gate-to-Emitter Voltage**

**Fig. 6. Input Admittance**


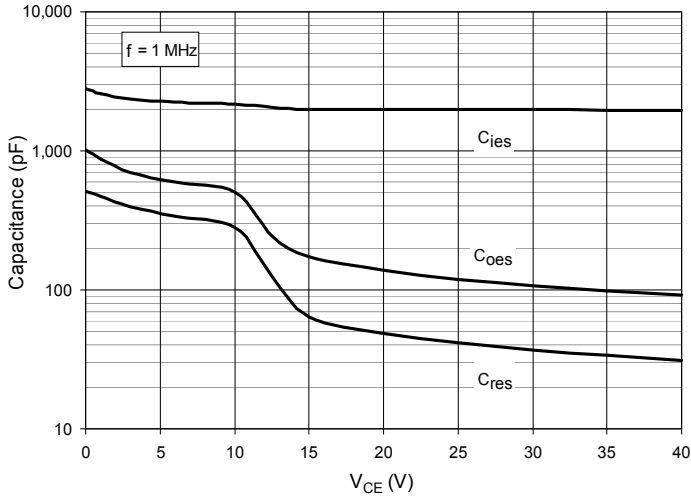
**Fig. 7. Transconductance**



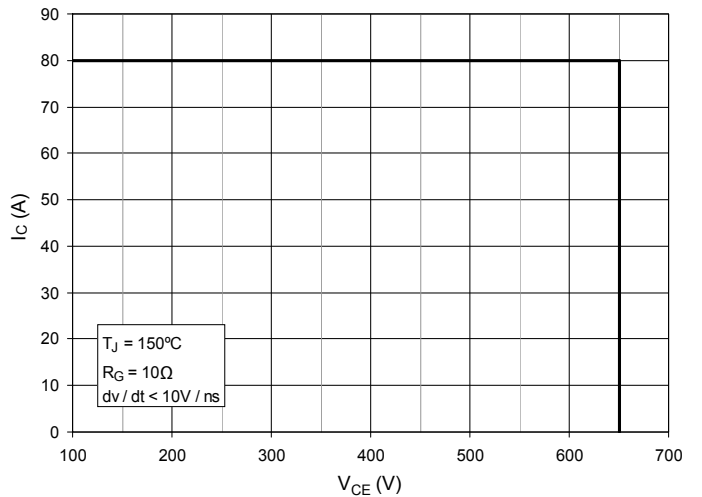
**Fig. 8. Gate Charge**



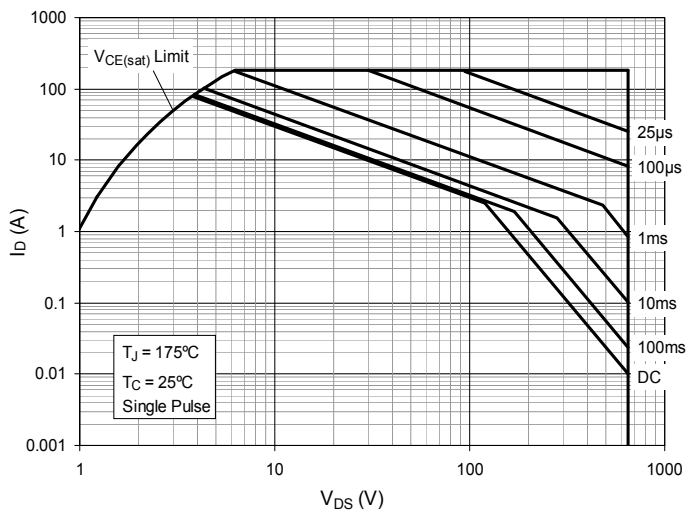
**Fig. 9. Capacitance**



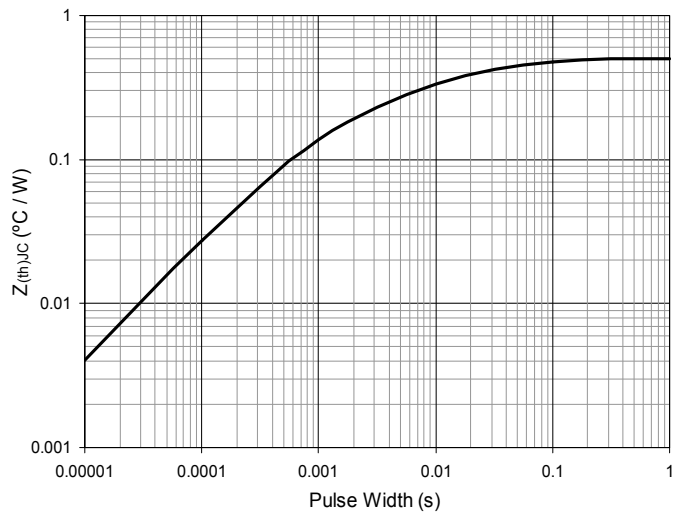
**Fig. 10. Reverse-Bias Safe Operating Area**

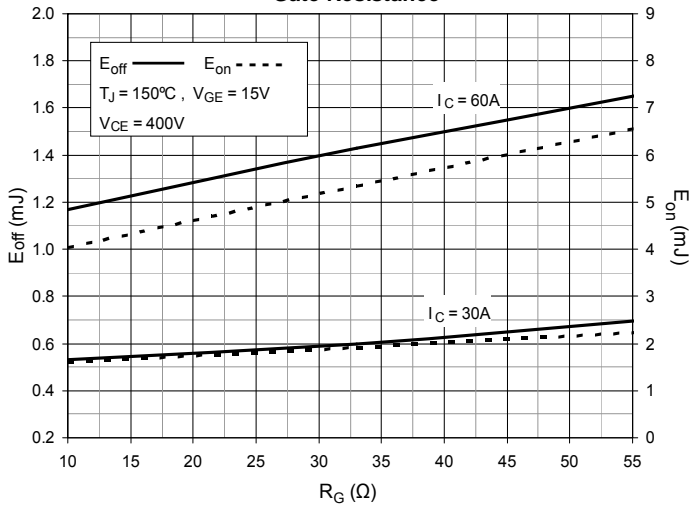
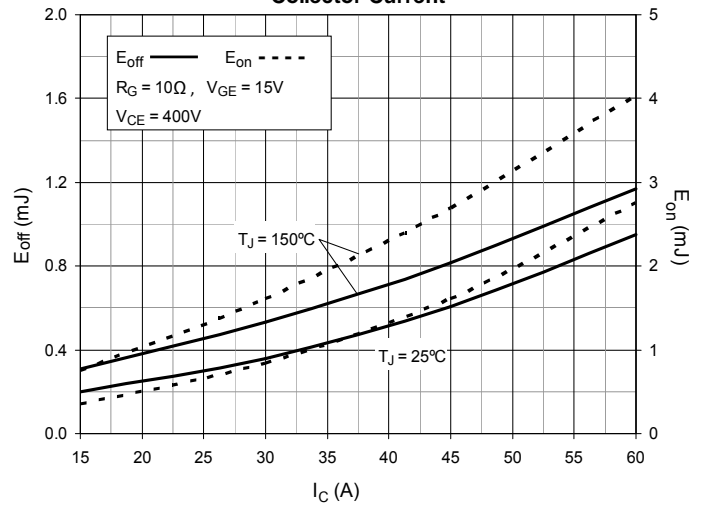
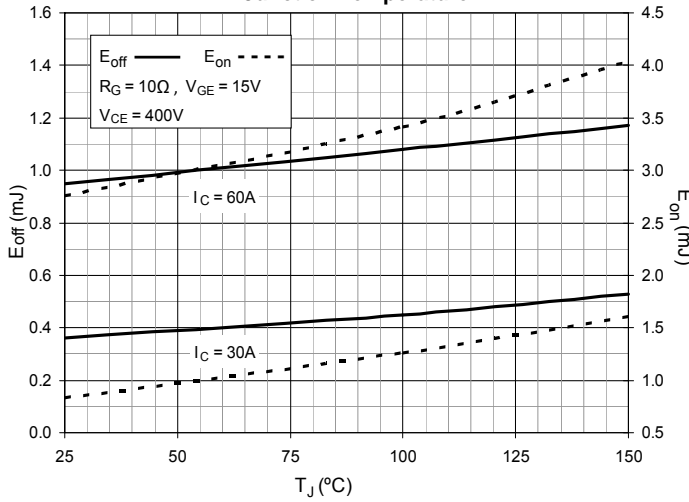
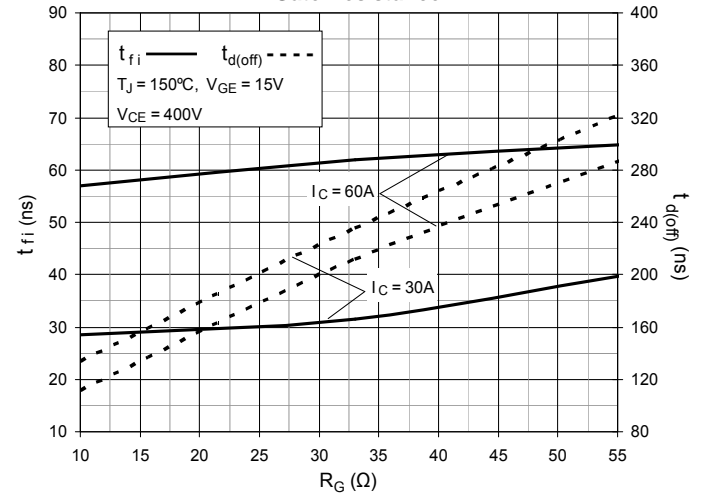
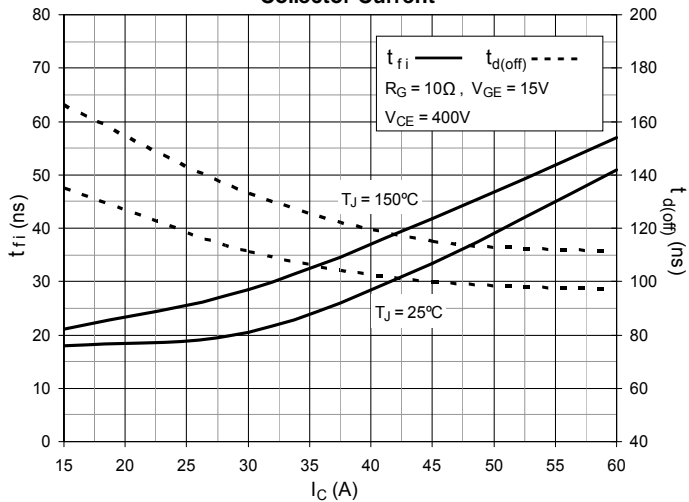
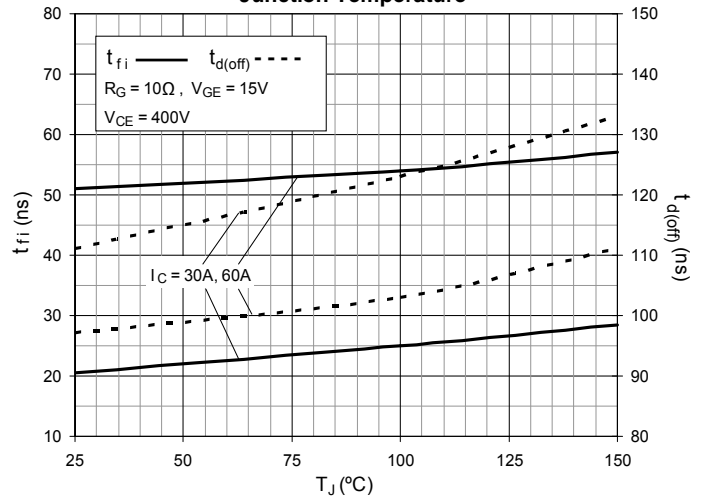


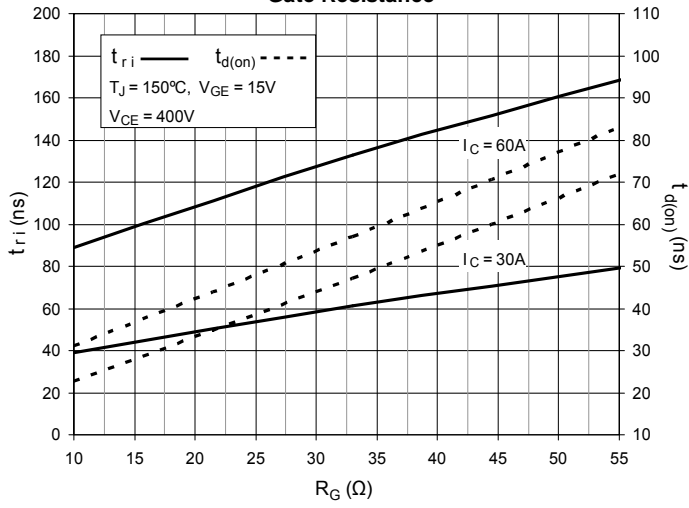
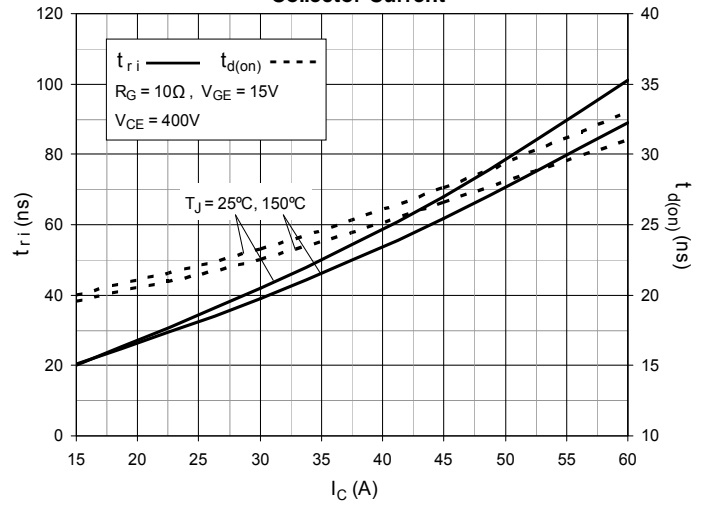
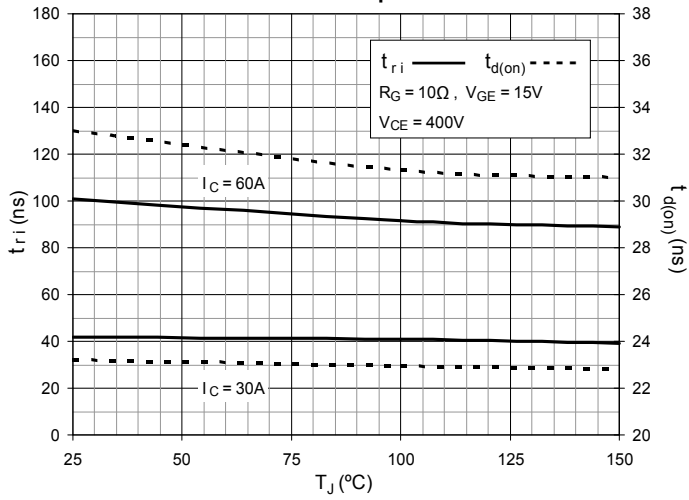
**Fig. 11. Forward-Bias Safe Operating Area**



**Fig. 12. Maximum Transient Thermal Impedance**



**Fig. 13. Inductive Switching Energy Loss vs. Gate Resistance**

**Fig. 14. Inductive Switching Energy Loss vs. Collector Current**

**Fig. 15. Inductive Switching Energy Loss vs. Junction Temperature**

**Fig. 16. Inductive Turn-off Switching Times vs. Gate Resistance**

**Fig. 17. Inductive Turn-off Switching Times vs. Collector Current**

**Fig. 18. Inductive Turn-off Switching Times vs. Junction Temperature**


**Fig. 19. Inductive Turn-on Switching Times vs. Gate Resistance**

**Fig. 20. Inductive Turn-on Switching Times vs. Collector Current**

**Fig. 21. Inductive Turn-on Switching Times vs. Junction Temperature**




---

Disclaimer Notice - Information furnished is believed to be accurate and reliable. However, users should independently evaluate the suitability of and test each product selected for their own applications. Littelfuse products are not designed for, and may not be used in, all applications. Read complete Disclaimer Notice at [www.littelfuse.com/disclaimer-electronics](http://www.littelfuse.com/disclaimer-electronics).