

High Voltage Power MOSFETs

IXTH02N250 IXTV02N250S

$$V_{DSS} = 2500V$$

$$I_{D25} = 200mA$$

$$R_{DS(on)} \leq 450\Omega$$

N-Channel Enhancement Mode
Fast Intrinsic Diode



Symbol	Test Conditions	Maximum Ratings	
V_{DSS}	$T_J = 25^\circ C$ to $150^\circ C$	2500	V
V_{DGR}	$T_J = 25^\circ C$ to $150^\circ C$, $R_{GS} = 1M\Omega$	2500	V
V_{GSS}	Continuous	± 20	V
V_{GSM}	Transient	± 30	V
I_{D25}	$T_C = 25^\circ C$	200	mA
I_{DM}	$T_C = 25^\circ C$, Pulse Width Limited by T_{JM}	600	mA
P_D	$T_C = 25^\circ C$	83	W
T_J		- 55 ... +150	$^\circ C$
T_{JM}		150	$^\circ C$
T_{stg}		- 55 ... +150	$^\circ C$
T_L	1.6mm (0.062 in.) from Case for 10s	300	$^\circ C$
T_{SOLD}	Plastic Body for 10s	260	$^\circ C$
M_d	Mounting Torque (TO-247)	1.13 / 10	Nm/lb.in
F_C	Mounting Force (PLUS220)	11..65 / 25..14.6	N/lb.
Weight	TO-247	6	g
	PLUS220	4	g

TO-247 (IXTH)

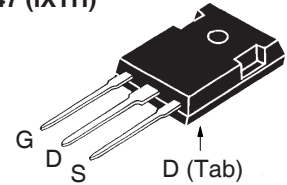

PLUS220SMD (IXTV_S)

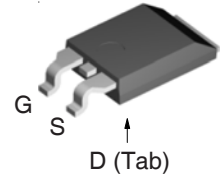

G = Gate D = Drain
S = Source Tab = Drain

Features

- Fast Intrinsic Diode
- Low Package Inductance

Advantages

- Easy to Mount
- Space Savings

Applications

- High Voltage Power Supplies
- Capacitor Discharge
- Pulse Circuits

Symbol	Test Conditions ($T_J = 25^\circ C$, Unless Otherwise Specified)	Characteristic Values		
		Min.	Typ.	Max.
BV_{DSS}	$V_{GS} = 0V$, $I_D = 250\mu A$	2500		V
$V_{GS(th)}$	$V_{DS} = V_{GS}$, $I_D = 250\mu A$	2.5		4.5 V
I_{GSS}	$V_{GS} = \pm 20V$, $V_{DS} = 0V$			± 100 nA
I_{DSS}	$V_{DS} = 0.8 \cdot V_{DSS}$, $V_{GS} = 0V$ $T_J = 125^\circ C$			5 μA
				500 μA
$R_{DS(on)}$	$V_{GS} = 10V$, $I_D = 50mA$, Note 1			450 Ω

Symbol	Test Conditions ($T_J = 25^\circ\text{C}$, Unless Otherwise Specified)	Characteristic Values		
		Min.	Typ.	Max.
g_{fs}	$V_{DS} = 100\text{V}$, $I_D = 0.5 \cdot I_{D25}$, Note 1	88	145	mS
C_{iss}	$V_{GS} = 0\text{V}$, $V_{DS} = 25\text{V}$, $f = 1\text{MHz}$		116	pF
C_{oss}			8	pF
C_{rss}			3	pF
$t_{d(on)}$	Resistive Switching Times $V_{GS} = 10\text{V}$, $V_{DS} = 0.5 \cdot V_{DSS}$, $I_D = 0.5 \cdot I_{D25}$ $R_G = 100\Omega$ (External)		19	ns
t_r			19	ns
$t_{d(off)}$			32	ns
t_f			33	ns
$Q_{g(on)}$	$V_{GS} = 10\text{V}$, $V_{DS} = 0.5 \cdot V_{DSS}$, $I_D = 0.5 \cdot I_{D25}$		7.4	nC
Q_{gs}			0.7	nC
Q_{gd}			5.3	nC
R_{thJC}			1.5	$^\circ\text{C/W}$
R_{thCS}		0.25		$^\circ\text{C/W}$

Source-Drain Diode

Symbol	Test Conditions ($T_J = 25^\circ\text{C}$, Unless Otherwise Specified)	Characteristic Values		
		Min.	Typ.	Max.
I_S	$V_{GS} = 0\text{V}$			200 mA
I_{SM}	Repetitive, Pulse Width Limited by T_{JM}			800 mA
V_{SD}	$I_F = 100\text{mA}$, $V_{GS} = 0\text{V}$, Note 1			2.0 V
t_{rr}	$I_F = 200\text{mA}$, $-di/dt = 50\text{A}/\mu\text{s}$, $V_R = 100\text{V}$		1.5	μs

Note 1. Pulse test, $t \leq 300\mu\text{s}$, duty cycle, $d \leq 2\%$.

*Additional provisions for lead to lead voltage isolation are required at $V_{DS} > 1200\text{V}$.

TO-247 Outline

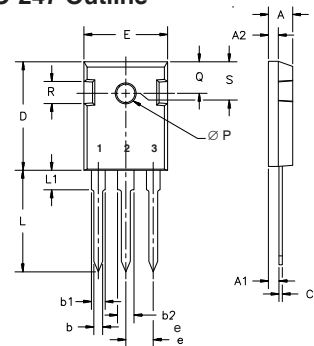

Terminals: 1 - Gate
2 - Drain
3 - Source

Dim.	Millimeter		Inches	
	Min.	Max.	Min.	Max.
A	4.7	5.3	.185	.209
A ₁	2.2	2.54	.087	.102
A ₂	2.2	2.6	.059	.098
b	1.0	1.4	.040	.055
b ₁	1.65	2.13	.065	.084
b ₂	2.87	3.12	.113	.123
C	.4	.8	.016	.031
D	20.80	21.46	.819	.845
E	15.75	16.26	.610	.640
e	5.20	5.72	0.205	0.225
L	19.81	20.32	.780	.800
L ₁		4.50		.177
ØP	3.55	3.65	.140	.144
Q	5.89	6.40	0.232	0.252
R	4.32	5.49	.170	.216
S	6.15 BSC		242 BSC	

PLUS220SMD Outline

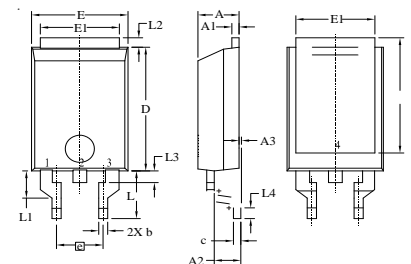

1. Gate 2. Drain
3. Source 4. Drain

SYM	INCHES		MILLIMETER	
	MIN	MAX	MIN	MAX
A	.169	.185	4.30	4.70
A ₁	.028	.035	0.70	0.90
A ₂	.098	.118	2.50	3.00
A ₃	.000	.010	0.00	0.25
b	.035	.047	0.90	1.20
b ₁	.080	.095	2.03	2.41
b ₂	.054	.064	1.37	1.63
c	.028	.035	0.70	0.90
D	.551	.591	14.00	15.00
D ₁	.512	.539	13.00	13.70
E	.394	.433	10.00	11.00
E ₁	.331	.346	8.40	8.80
e	.200BSC		5.08 BSC	
L	.209	.228	5.30	5.80
L ₁	.118	.138	3.00	3.50
L ₂	.035	.051	0.90	1.30
L ₃	.045	.053	1.25	1.35
L ₄	.039	.059	1.00	1.50

IXYS Reserves the Right to Change Limits, Test Conditions, and Dimensions.

IXYS MOSFETs and IGBTs are covered 4,835,592 4,931,844 5,049,961 5,237,481 6,162,665 6,404,065 B1 6,683,344 6,727,585 7,005,734 B2 7,157,338B2
by one or more of the following U.S. patents: 4,860,072 5,017,508 5,063,307 5,381,025 6,259,123 B1 6,534,343 6,710,405 B2 6,759,692 7,063,975 B2
4,881,106 5,034,796 5,187,117 5,486,715 6,306,728 B1 6,583,505 6,710,463 6,771,478 B2 7,071,537

Fig. 1. Output Characteristics @ $T_J = 25^\circ\text{C}$

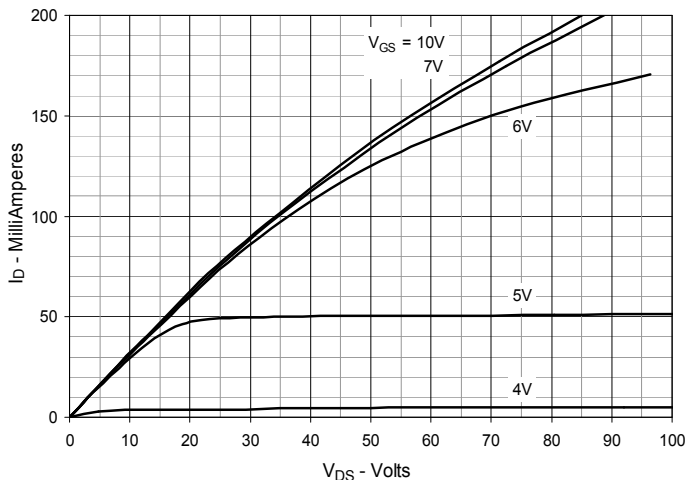

Fig. 2. Extended Output Characteristics @ $T_J = 25^\circ\text{C}$

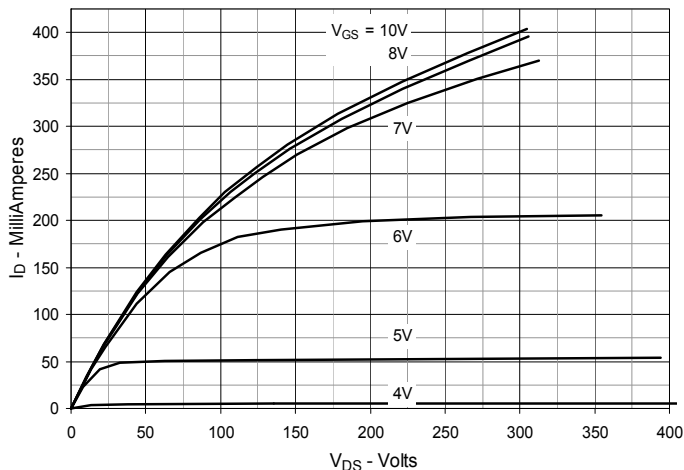

Fig. 3. Output Characteristics @ $T_J = 125^\circ\text{C}$

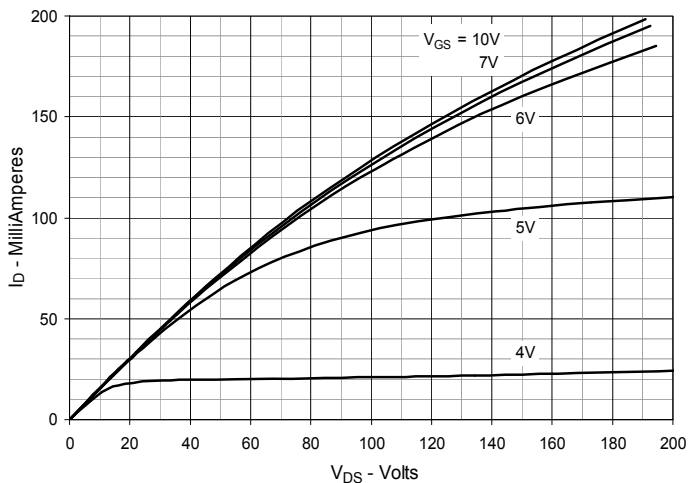

Fig. 4. $R_{DS(on)}$ Normalized to $I_D = 100\text{mA}$ Value vs. Junction Temperature

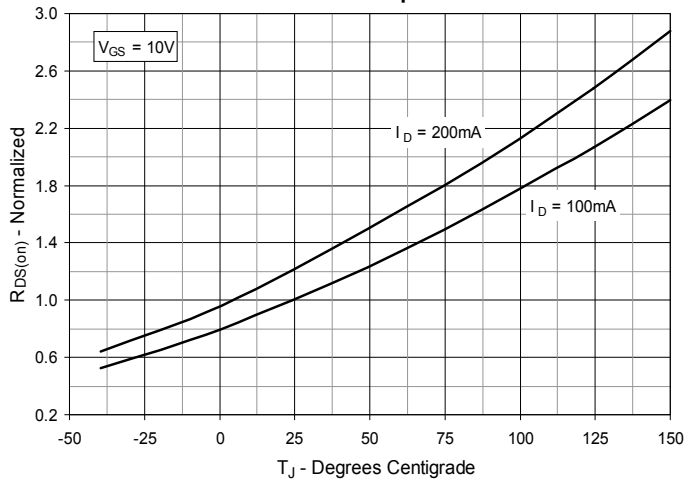

Fig. 5. $R_{DS(on)}$ Normalized to $I_D = 100\text{mA}$ Value vs. Drain Current

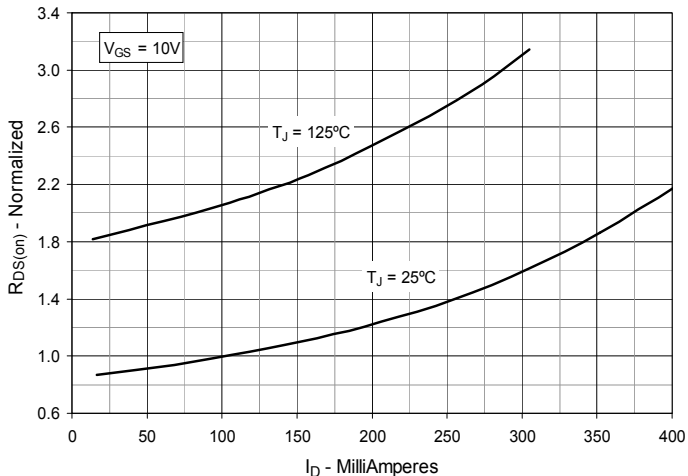

Fig. 6. Maximum Drain Current vs. Case Temperature

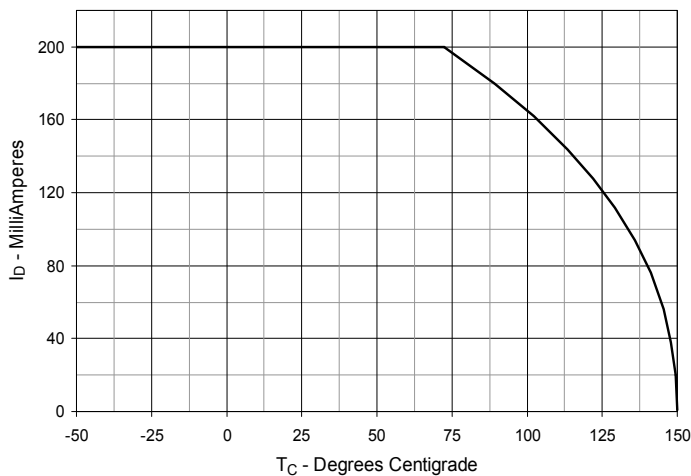

Fig. 7. Input Admittance

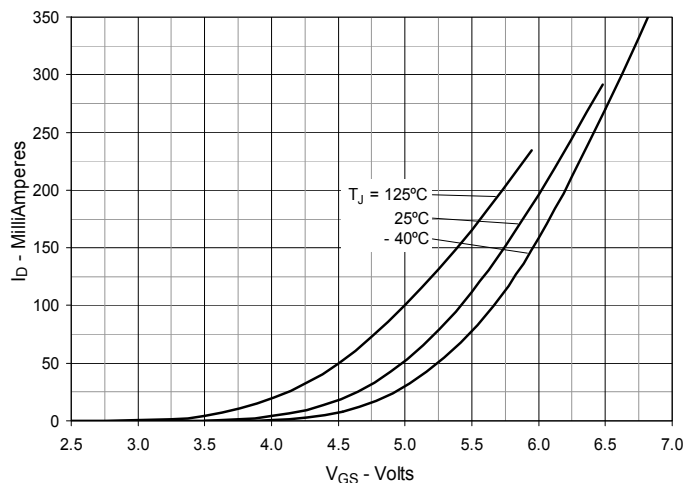

Fig. 8. Transconductance

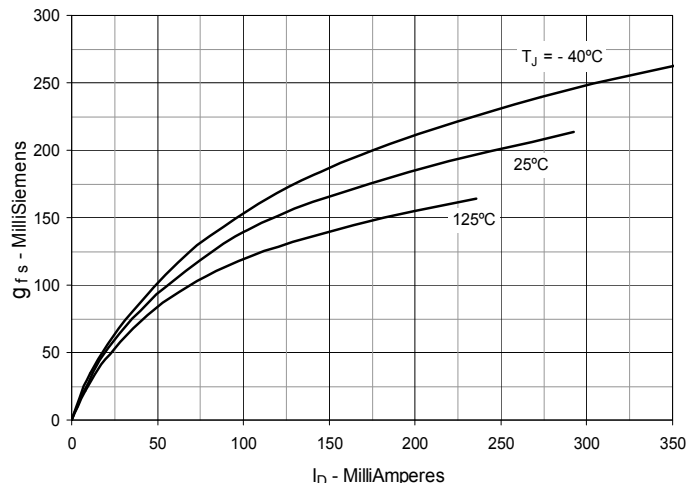

Fig. 9. Forward Voltage Drop of Intrinsic Diode

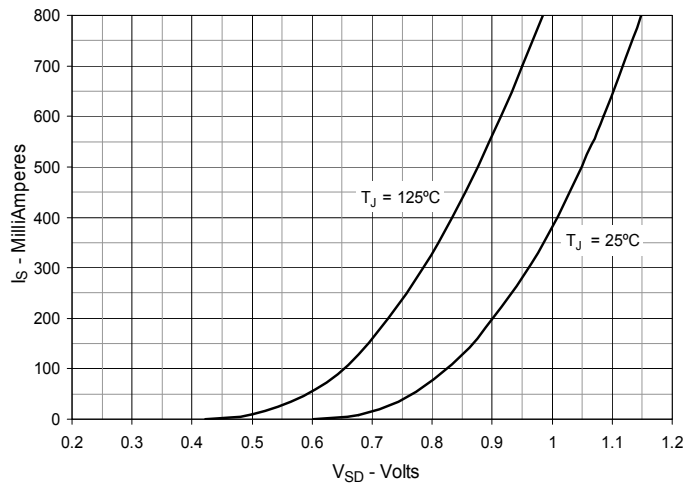

Fig. 10. Gate Charge

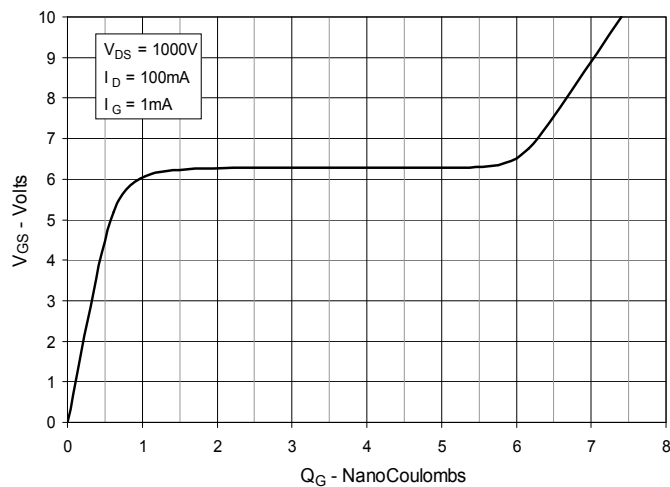

Fig. 11. Capacitance

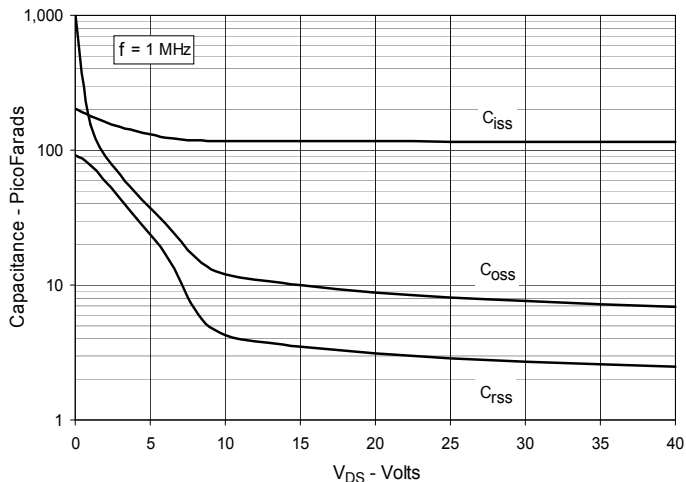

Fig. 12. Maximum Transient Thermal Impedance

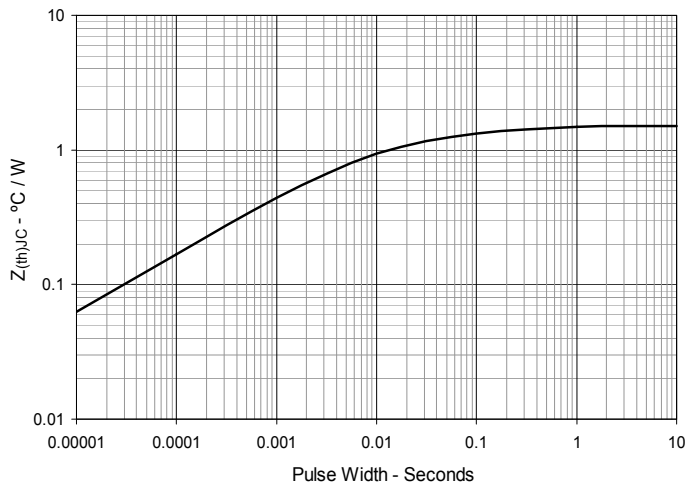

Fig. 13. Forward-Bias Safe Operating Area
@ $T_C = 25^\circ\text{C}$

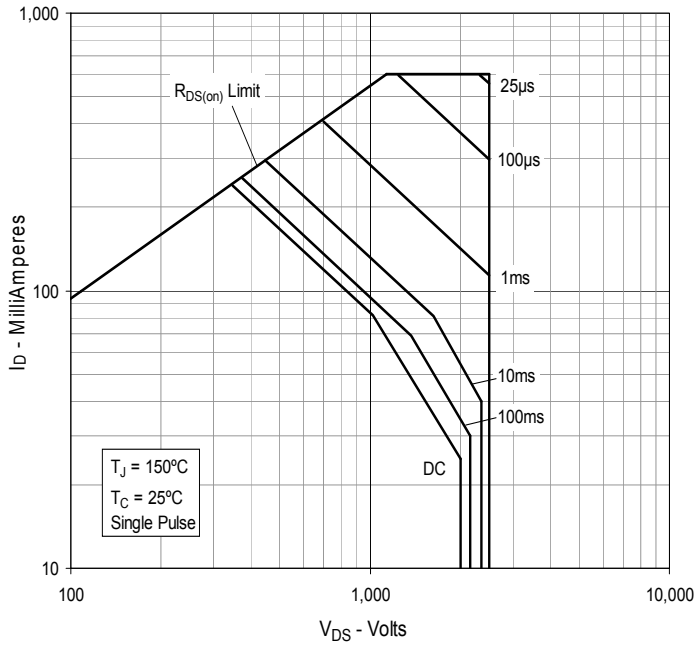
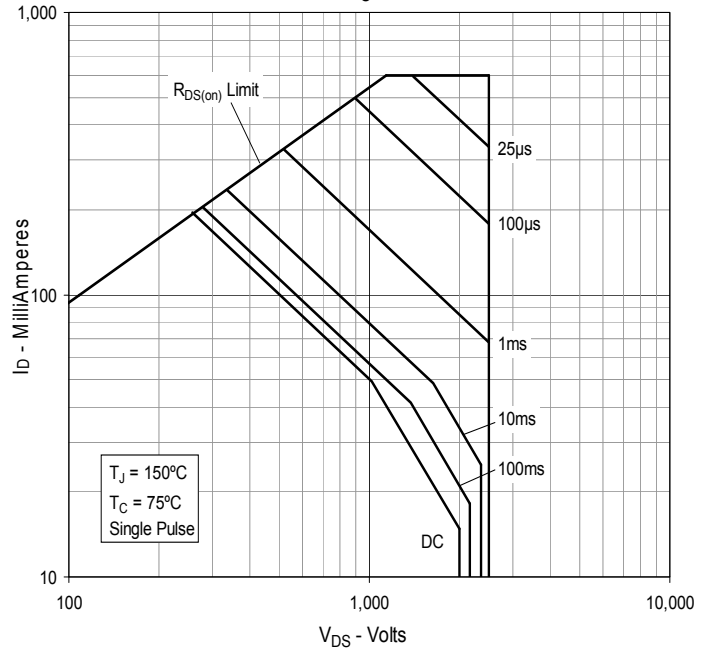

Fig. 14. Forward-Bias Safe Operating Area
@ $T_C = 75^\circ\text{C}$





Disclaimer Notice - Information furnished is believed to be accurate and reliable. However, users should independently evaluate the suitability of and test each product selected for their own applications. Littelfuse products are not designed for, and may not be used in, all applications. Read complete Disclaimer Notice at www.littelfuse.com/disclaimer-electronics.