

# Polar™ Power MOSFET

## IXTY08N100P IXTA08N100P IXTP08N100P

$V_{DSS} = 1000V$   
 $I_{D25} = 0.8A$   
 $R_{DS(on)} \leq 20\Omega$

N-Channel Enhancement Mode  
Avalanche Rated



Symbol	Test Conditions	Maximum Ratings	
$V_{DSS}$	$T_J = 25^\circ C$ to $150^\circ C$	1000	V
$V_{DGR}$	$T_J = 25^\circ C$ to $150^\circ C$ , $R_{GS} = 1M\Omega$	1000	V
$V_{GSS}$	Continuous	$\pm 20$	V
$V_{GSM}$	Transient	$\pm 30$	V
$I_{D25}$	$T_C = 25^\circ C$	0.8	A
$I_{DM}$	$T_C = 25^\circ C$ , Pulse Width Limited by $T_{JM}$	1.5	A
$I_A$	$T_C = 25^\circ C$	0.8	A
$E_{AS}$	$T_C = 25^\circ C$	80	mJ
$dv/dt$	$I_S \leq I_{DM}$ , $V_{DD} \leq V_{DSS}$ , $T_J \leq 150^\circ C$	10	V/ns
$P_D$	$T_C = 25^\circ C$	42	W
$T_J$		-55 ... +150	$^\circ C$
$T_{JM}$		150	$^\circ C$
$T_{stg}$		-55 ... +150	$^\circ C$
$T_L$	Maximum Lead Temperature for Soldering	300	$^\circ C$
$T_{SOLD}$	1.6 mm (0.062in.) from Case for 10s	260	$^\circ C$
$F_C$	Mounting Force (TO-263)	10..65 / 2.2..14.6	N/lb
$M_d$	Mounting Torque (TO-220)	1.13 / 10	Nm/lb.in
<b>Weight</b>	TO-252	0.35	g
	TO-263	2.50	g
	TO-220	3.00	g

Symbol	Test Conditions ( $T_J = 25^\circ C$ , Unless Otherwise Specified)	Characteristic Values		
		Min.	Typ.	Max.
$BV_{DSS}$	$V_{GS} = 0V$ , $I_D = 250\mu A$	1000		V
$V_{GS(th)}$	$V_{DS} = V_{GS}$ , $I_D = 50\mu A$	2.0		4.0 V
$I_{GSS}$	$V_{GS} = \pm 20V$ , $V_{DS} = 0V$			$\pm 50$ nA
$I_{DSS}$	$V_{DS} = V_{DSS}$ , $V_{GS} = 0V$ $T_J = 125^\circ C$			3 $\mu A$ 100 $\mu A$
$R_{DS(on)}$	$V_{GS} = 10V$ , $I_D = 0.5 \cdot I_{D25}$ , Note 1		17	20 $\Omega$

TO-252 (IXTY)

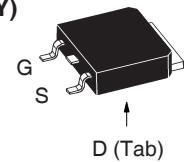

TO-263 (IXTA)

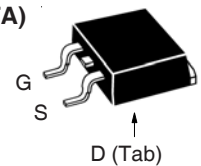

TO-220 (IXTP)

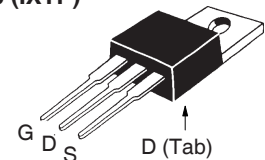

G = Gate      D = Drain  
S = Source    Tab = Drain

### Features

- International Standard Packages
- Low  $Q_G$
- Avalanche Rated
- Low Package Inductance
- Fast Intrinsic Rectifier

### Advantages

- High Power Density
- Easy to Mount
- Space Savings

### Applications

- DC-DC Converters
- Switch-Mode and Resonant-Mode Power Supplies
- AC and DC Motor Drives
- Lasers Driverserators
- Robotics and Servo Controls

Symbol	Test Conditions ( $T_J = 25^\circ\text{C}$ , Unless Otherwise Specified)	Characteristic Values		
		Min.	Typ.	Max
$g_{fs}$	$V_{DS} = 30\text{V}$ , $I_D = 0.5 \cdot I_{D25}$ , Note 1	0.35	0.60	S
$C_{iss}$	$V_{GS} = 0\text{V}$ , $V_{DS} = 25\text{V}$ , $f = 1\text{MHz}$		240	pF
$C_{oss}$			18	pF
$C_{rss}$			3.6	pF
$Q_{g(on)}$	$V_{GS} = 10\text{V}$ , $V_{DS} = 0.5 \cdot V_{DSS}$ , $I_D = 0.5 \cdot I_{D25}$		11.3	nC
$Q_{gs}$			1.7	nC
$Q_{gd}$			6.7	nC
$t_{d(on)}$	<b>Resistive Switching Times</b> $V_{GS} = 10\text{V}$ , $V_{DS} = 0.5 \cdot V_{DSS}$ , $I_D = 0.5 \cdot I_{D25}$ $R_G = 50\Omega$ (External)		19	ns
$t_r$			37	ns
$t_{d(off)}$			35	ns
$t_f$			34	ns
$R_{thJC}$				3.0 $^\circ\text{C/W}$
$R_{thCS}$	TO-220	0.50		$^\circ\text{C/W}$

#### Source-Drain Diode

Symbol	Test Conditions ( $T_J = 25^\circ\text{C}$ , Unless Otherwise Specified)	Characteristic Values		
		Min.	Typ.	Max
$I_S$	$V_{GS} = 0\text{V}$			0.8 A
$I_{SM}$	Repetitive, Pulse Width Limited by $T_{JM}$			2.4 A
$V_{SD}$	$I_F = I_S$ , $V_{GS} = 0\text{V}$ , Note 1			1.5 V
$t_{rr}$	$I_F = 0.8\text{A}$ , $-di/dt = 100\text{A}/\mu\text{s}$ , $V_R = 100\text{V}$		750	ns

Note 1. Pulse test,  $t \leq 300\mu\text{s}$ , duty cycle,  $d \leq 2\%$ .

IXYS Reserves the Right to Change Limits, Test Conditions, and Dimensions.

IXYS MOSFETs and IGBTs are covered by one or more of the following U.S. patents:	4,835,592	4,931,844	5,049,961	5,237,481	6,162,665	6,404,065B1	6,683,344	6,727,585	7,005,734B2	7,157,338B2
	4,860,072	5,017,508	5,063,307	5,381,025	6,259,123B1	6,534,343	6,710,405B2	6,759,692	7,063,975B2	
	4,881,106	5,034,796	5,187,117	5,486,715	6,306,728B1	6,583,505	6,710,463	6,771,478B2	7,071,537	

Fig. 1. Output Characteristics @  $T_J = 25^\circ\text{C}$

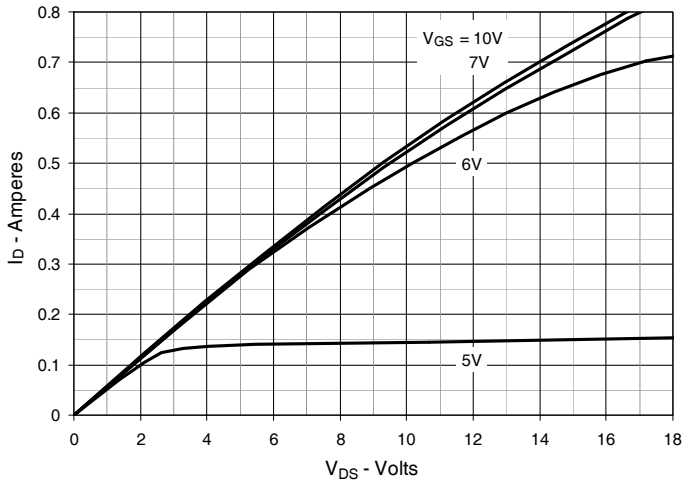

Fig. 2. Extended Output Characteristics @  $T_J = 25^\circ\text{C}$

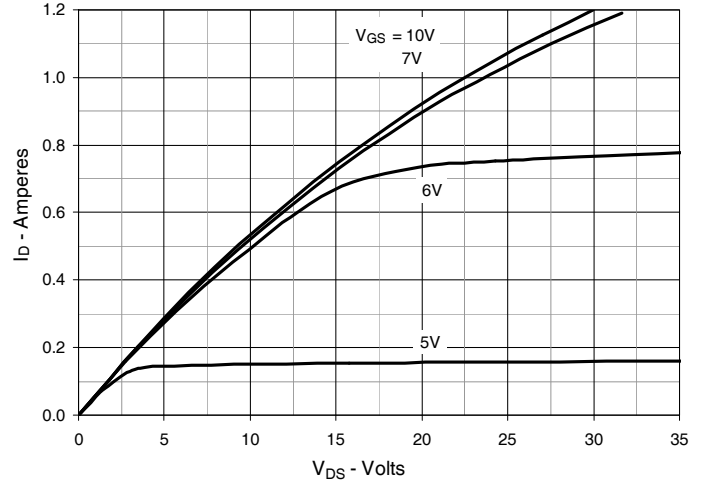

Fig. 3. Output Characteristics @  $T_J = 125^\circ\text{C}$

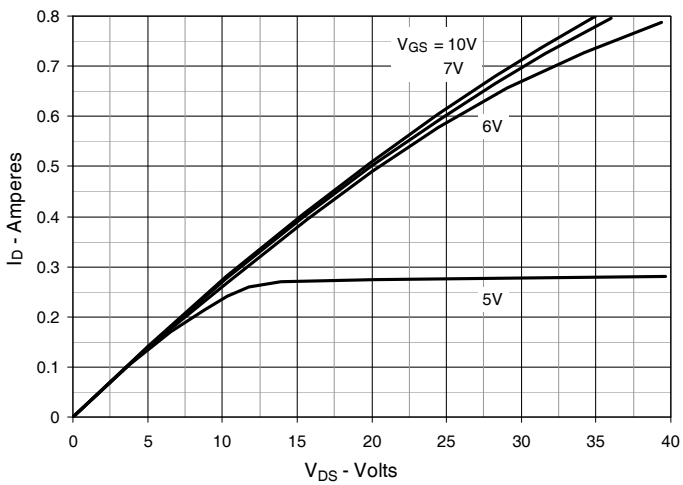

Fig. 4.  $R_{DS(on)}$  Normalized to  $I_D = 0.4\text{A}$  Value vs. Junction Temperature

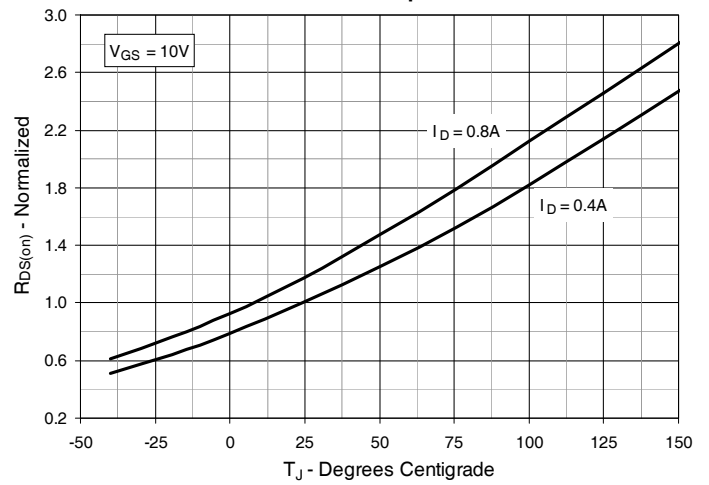

Fig. 5.  $R_{DS(on)}$  Normalized to  $I_D = 0.4\text{A}$  Value vs. Drain Current

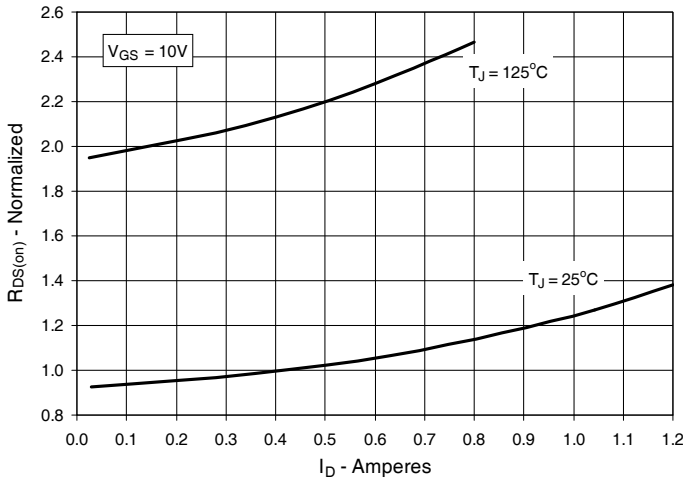

Fig. 6. Maximum Drain Current vs. Case Temperature

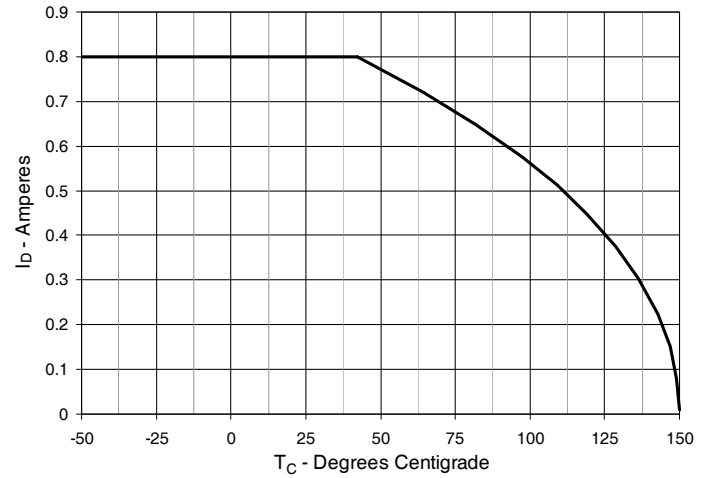

Fig. 7. Input Admittance

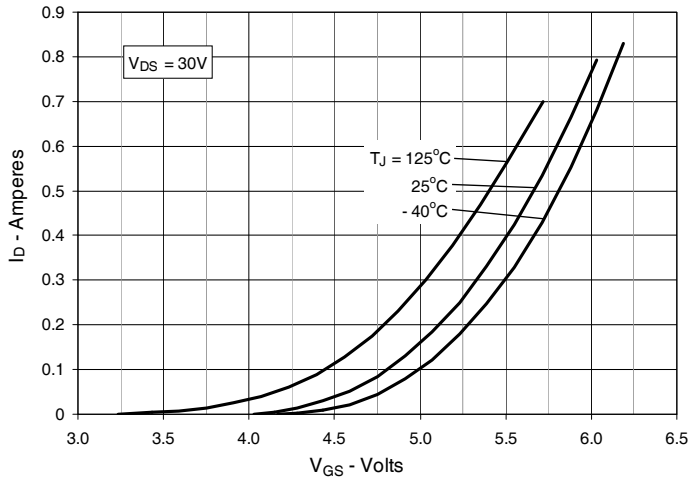

Fig. 8. Transconductance

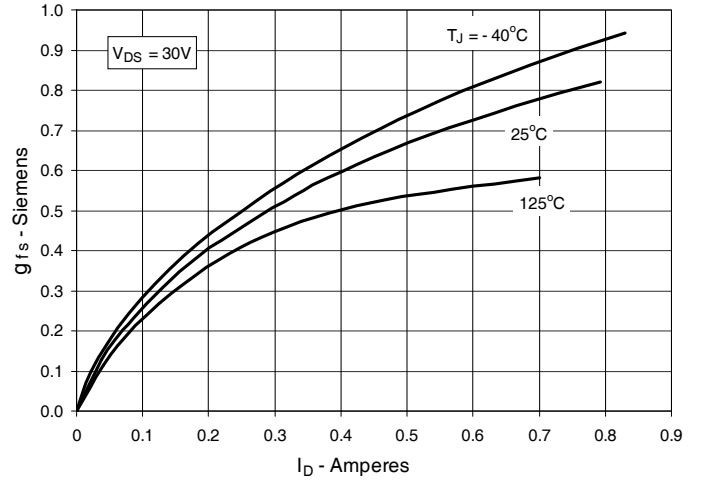

Fig. 9. Forward Voltage Drop of Intrinsic Diode

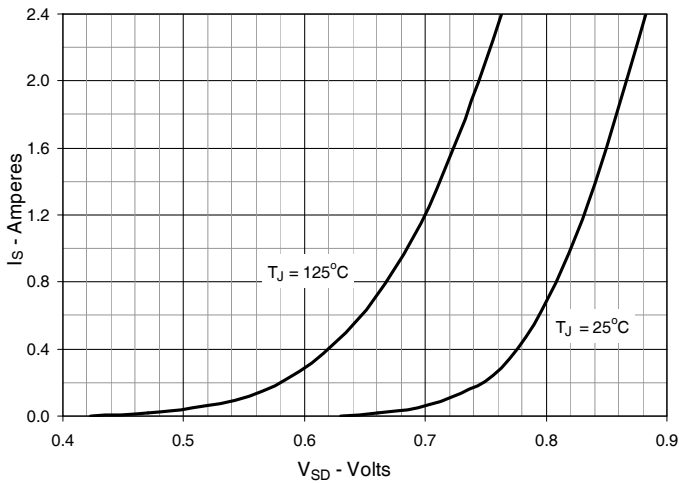

Fig. 10. Gate Charge

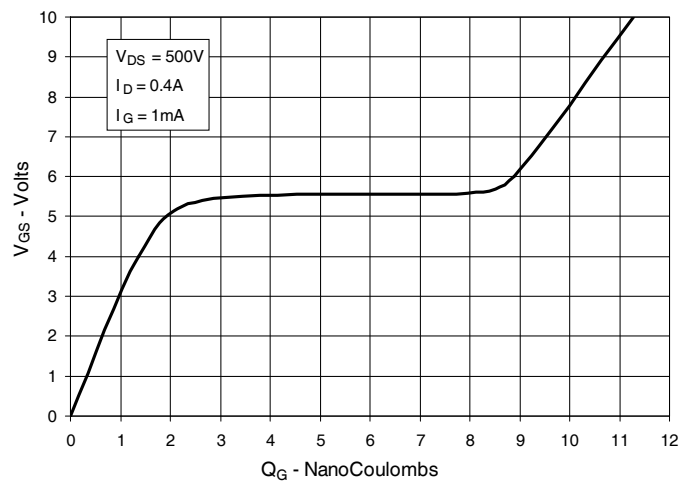

Fig. 11. Capacitance

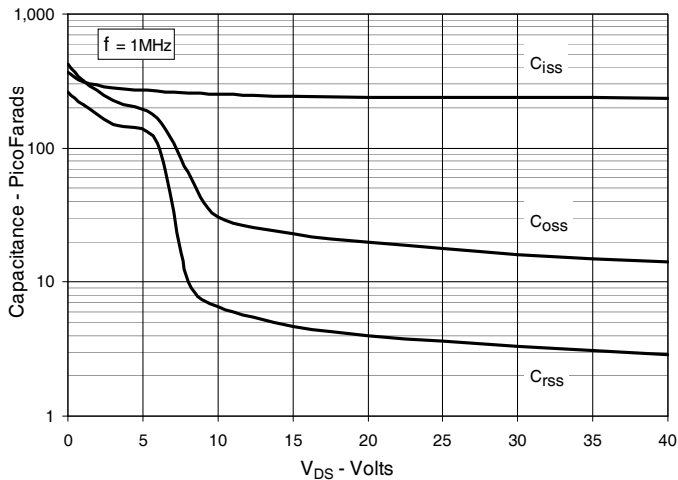
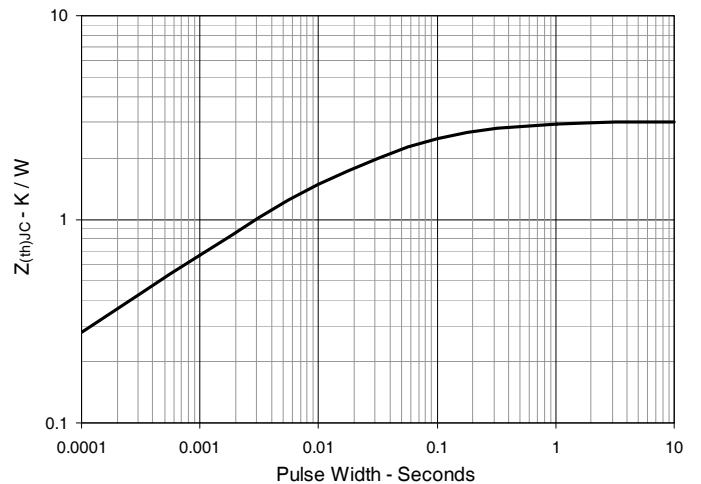

Fig. 12. Maximum Transient Thermal Impedance



### TO-252 AA Outline



SYM	INCHES		MILLIMETERS	
	MIN	MAX	MIN	MAX
A	.086	.094	2.19	2.38
A1	0	.005	0	0.12
A2	.038	.046	0.97	1.17
b	.025	.035	0.64	0.89
b2	.030	.045	0.76	1.14
b3	.200	.215	5.08	5.46
c	.018	.024	0.46	0.61
c2	.018	.023	0.46	0.58
D	.235	.245	5.97	6.22
D1	.180	.205	4.57	5.21
E	.250	.265	6.35	6.73
E1	.170	.205	4.32	5.21
e	.090 BSC		2.28 BSC	
e1	.180 BSC		4.57 BSC	
H	.370	.410	9.40	10.42
L	.055	.070	1.40	1.78
L1	.100	.115	2.54	2.92
L2	.020 BSC		0.50 BSC	
L3	.025	.040	0.64	1.02
L4	.025	.040	0.64	1.02
θ	0°	10°	0°	10°

### TO-263 Outline

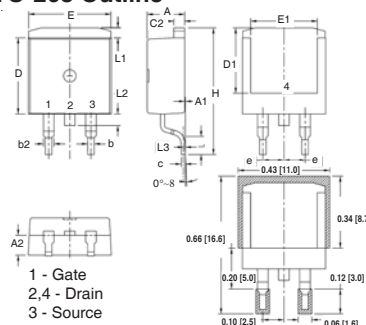

SYM	INCHES		MILLIMETER	
	MIN	MAX	MIN	MAX
A	.170	.185	4.30	4.70
A1	.000	.008	0.00	0.20
A2	.091	.098	2.30	2.50
b	.028	.035	0.70	0.90
b2	.046	.060	1.18	1.52
C	.018	.024	0.45	0.60
C2	.049	.060	1.25	1.52
D	.340	.370	8.63	9.40
D1	.300	.327	7.62	8.30
E	.380	.410	9.65	10.41
E1	.270	.330	6.86	8.38
e	.100 BSC		2.54 BSC	
H	.580	.620	14.73	15.75
L	.075	.105	1.91	2.67
L1	.039	.060	1.00	1.52
L2	—	.070	—	1.77
L3	.010 BSC		0.254 BSC	

### TO-220 Outline

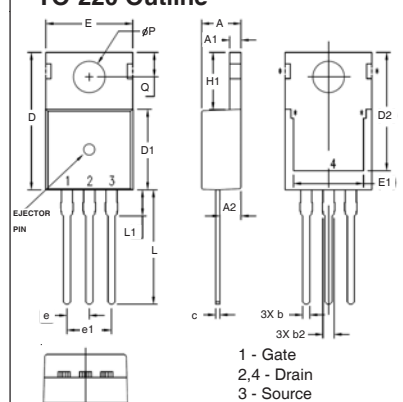

SYM	INCHES		MILLIMETERS	
	MIN	MAX	MIN	MAX
A	.169	.185	4.30	4.70
A1	.047	.055	1.20	1.40
A2	.079	.106	2.00	2.70
b	.024	.039	0.60	1.00
b2	.045	.057	1.15	1.45
c	.014	.026	0.35	0.65
D	.587	.626	14.90	15.90
D1	.335	.370	8.50	9.40
(D2)	.500	.531	12.70	13.50
E	.382	.406	9.70	10.30
(E1)	.283	.323	7.20	8.20
e	.100 BSC		2.54 BSC	
e1	.200 BSC		5.08 BSC	
H1	.244	.268	6.20	6.80
L	.492	.547	12.50	13.90
L1	.110	.154	2.80	3.90
∅P	.134	.150	3.40	3.80
Q	.106	.126	2.70	3.20



---

Disclaimer Notice - Information furnished is believed to be accurate and reliable. However, users should independently evaluate the suitability of and test each product selected for their own applications. Littelfuse products are not designed for, and may not be used in, all applications. Read complete Disclaimer Notice at [www.littelfuse.com/disclaimer-electronics](http://www.littelfuse.com/disclaimer-electronics).