

GenX3™ 600V IGBT with Diode

IXGR72N60C3D1

High-Speed Low-V_{sat} PT IGBT
40-100 kHz Switching

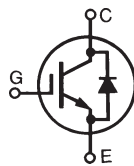

$$V_{CES} = 600V$$

$$I_{C110} = 35A$$

$$V_{CE(sat)} \leq 2.7V$$

$$t_{fi(typ)} = 55ns$$

Symbol	Test Conditions	Maximum Ratings	
V_{CES}	$T_J = 25^\circ C$ to $150^\circ C$	600	V
V_{CGR}	$T_J = 25^\circ C$ to $150^\circ C$, $R_{GE} = 1M\Omega$	600	V
V_{GES}	Continuous	± 20	V
V_{GEM}	Transient	± 30	V
I_{C25}	$T_C = 25^\circ C$ (Limited by Leads)	75	A
I_{C110}	$T_C = 110^\circ C$	35	A
I_{F110}	$T_C = 110^\circ C$	36	A
I_{CM}	$T_C = 25^\circ C$, 1ms	400	A
I_A	$T_C = 25^\circ C$	50	A
E_{AS}	$T_C = 25^\circ C$	500	mJ
SSOA	$V_{GE} = 15V$, $T_{VJ} = 125^\circ C$, $R_G = 2\Omega$	$I_{CM} = 150$	A
(RBSOA)	Clamped Inductive Load	$V_{CE} \leq V_{CES}$	
P_C	$T_C = 25^\circ C$	200	W
T_J		-55 ... +150	$^\circ C$
T_{JM}		150	$^\circ C$
T_{stg}		-55 ... +150	$^\circ C$
V_{ISOL}	50/60 Hz, RMS, t = 1Minute $I_{ISOL} < 1mA$ t = 20 Seconds	2500 3000	V~ V~
F_C	Mounting Force	20..120/4.5..27	N/lb
T_L	Maximum Lead Temperature for Soldering	300	$^\circ C$
T_{SOLD}	1.6mm (0.062 in.) from Case for 10s	260	$^\circ C$
Weight		5	g

ISOPLUS 247™

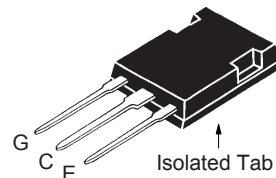

G = Gate C = Collector
E = Emitter

Features

- Silicon Chip on Direct-Copper Bond (DCB) Substrate
- Optimized for Low Switching Losses
- Square RBSOA
- Isolated Mounting Surface
- Anti-Parallel Ultra Fast Diode
- Avalanche Rated
- 2500V Electrical Isolation

Advantages

- High Power Density
- Low Gate Drive Requirement

Applications

- High Frequency Power Inverters
- UPS
- Motor Drives
- SMPS
- PFC Circuits
- Battery Chargers
- Welding Machines
- Lamp Ballasts

Symbol	Test Conditions ($T_J = 25^\circ C$, Unless Otherwise Specified)	Characteristic Values		
		Min.	Typ.	Max.
$V_{GE(th)}$	$I_C = 250\mu A$, $V_{CE} = V_{GE}$	3.0		5.5 V
I_{CES}	$V_{CE} = V_{CES}$, $V_{GE} = 0V$ $T_J = 125^\circ C$			300 μA 5 mA
I_{GES}	$V_{CE} = 0V$, $V_{GE} = \pm 20V$			± 100 nA
$V_{CE(sat)}$	$I_C = 50A$, $V_{GE} = 15V$, Note 1 $T_J = 125^\circ C$		2.10 1.65	V V

Symbol	Test Conditions ($T_J = 25^\circ\text{C}$, Unless Otherwise Specified)	Characteristic Values		
		Min.	Typ.	Max.
g_{fs}	$I_C = 50\text{A}$, $V_{CE} = 10\text{V}$, Note 1	33	55	S
C_{ies}	$V_{CE} = 25\text{V}$, $V_{GE} = 0\text{V}$, $f = 1\text{MHz}$		4780	pF
C_{oes}			330	pF
C_{res}			117	pF
Q_g	$I_C = 50\text{A}$, $V_{GE} = 15\text{V}$, $V_{CE} = 0.5 \cdot V_{CES}$		175	nC
Q_{ge}			33	nC
Q_{gc}			72	nC
$t_{d(on)}$	Inductive Load, $T_J = 25^\circ\text{C}$ $I_C = 50\text{A}$, $V_{GE} = 15\text{V}$ $V_{CE} = 480\text{V}$, $R_G = 2\Omega$, Note 2		27	ns
t_{ri}			37	ns
E_{on}			1.03	mJ
$t_{d(off)}$			77	130 ns
t_{fi}			55	110 ns
E_{off}			0.48	0.95 mJ
$t_{d(on)}$	Inductive Load, $T_J = 125^\circ\text{C}$ $I_C = 50\text{A}$, $V_{GE} = 15\text{V}$ $V_{CE} = 480\text{V}$, $R_G = 2\Omega$, Note 2		26	ns
t_{ri}			36	ns
E_{on}			1.48	mJ
$t_{d(off)}$			120	ns
t_{fi}			124	ns
E_{off}			0.93	mJ
R_{thJC}			0.62	$^\circ\text{C/W}$
R_{thCS}		0.15		$^\circ\text{C/W}$

ISOPLUS247 (IXGR) Outline

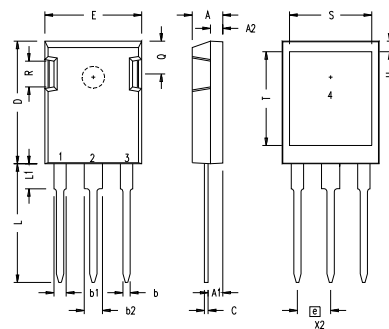

SYM	INCHES		MILLIMETERS	
	MIN	MAX	MIN	MAX
A	.190	.205	4.83	5.21
A1	.090	.100	2.29	2.54
A2	.075	.085	1.91	2.16
b	.045	.055	1.14	1.40
b1	.075	.084	1.91	2.13
b2	.115	.123	2.92	3.12
C	.024	.031	0.61	0.80
D	.819	.840	20.80	21.34
E	.620	.635	15.75	16.13
e	.215 BSC		5.45 BSC	
L	.780	.800	19.81	20.32
L1	.150	.170	3.81	4.32
Q	.220	.244	5.59	6.20
R	.170	.190	4.32	4.83
S	.520	.540	13.21	13.72
T	.620	.640	15.75	16.26
U	.065	.080	1.65	2.03

- 1 - GATE
- 2 - DRAIN (COLLECTOR)
- 3 - SOURCE (EMITTER)
- 4 - NO CONNECTION

NOTE: This drawing will meet all dimensions requirement of JEDEC outline TO-247AD except screw hole.

Reverse Diode (FRED)

Symbol	Test Conditions ($T_J = 25^\circ\text{C}$, Unless Otherwise Specified)	Characteristic Values		
		Min.	Typ.	Max.
V_F	$I_F = 60\text{A}$, $V_{GE} = 0\text{V}$, Note 1 $T_J = 150^\circ\text{C}$		1.4	2.5 V
I_{RM}	$I_F = 60\text{A}$, $V_{GE} = 0\text{V}$, $-di_F/dt = 100\text{A}/\mu\text{s}$, $V_R = 100\text{V}$ $T_J = 100^\circ\text{C}$		8.3	A
t_{rr}	$I_F = 1\text{A}$, $-di/dt = 200\text{A}/\mu\text{s}$, $V_R = 30\text{V}$		35	ns
R_{thJC}				0.85 $^\circ\text{C/W}$

Notes:

1. Pulse test, $t \leq 300\mu\text{s}$, duty cycle, $d \leq 2\%$.
2. Switching times & energy losses may increase for higher $V_{CE}(\text{Clamp})$, T_J or R_G .

IXYS Reserves the Right to Change Limits, Test Conditions, and Dimensions.

IXYS MOSFETs and IGBTs are covered by one or more of the following U.S. patents:	4,835,592	4,931,844	5,049,961	5,237,481	6,162,665	6,404,065 B1	6,683,344	6,727,585	7,005,734 B2	7,157,338B2
	4,850,072	5,017,508	5,063,307	5,381,025	6,259,123 B1	6,534,343	6,710,405 B2	6,759,692	7,063,975 B2	
	4,881,106	5,034,796	5,187,117	5,486,715	6,306,728 B1	6,583,505	6,710,463	6,771,478 B2	7,071,537	

Fig. 1. Output Characteristics @ $T_J = 25^\circ\text{C}$

Fig. 2. Extended Output Characteristics @ $T_J = 25^\circ\text{C}$

Fig. 3. Output Characteristics @ $T_J = 125^\circ\text{C}$

Fig. 4. Dependence of $V_{CE(sat)}$ on Junction Temperature

Fig. 5. Collector-to-Emitter Voltage vs. Gate-to-Emitter Voltage

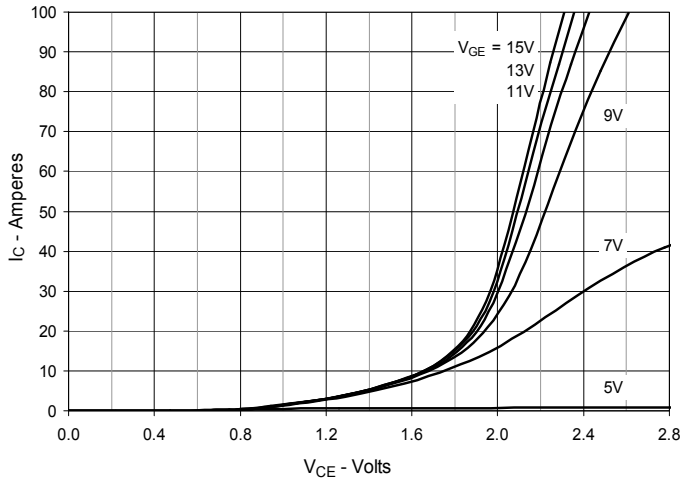
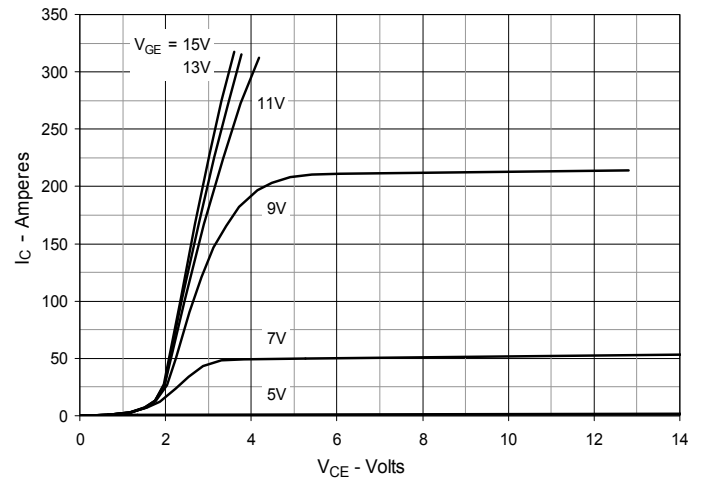
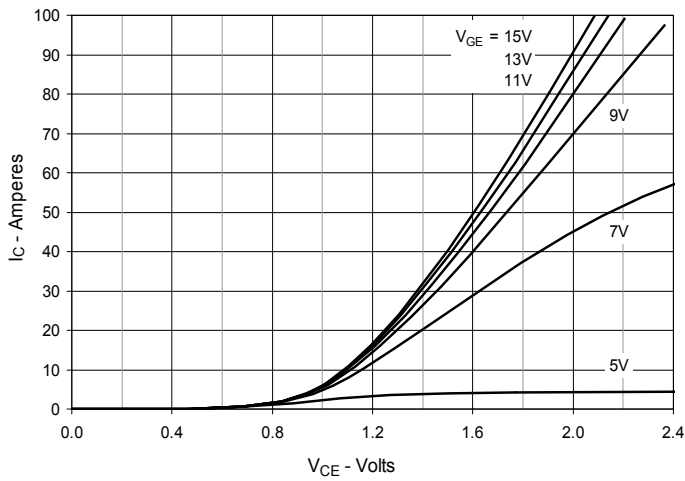
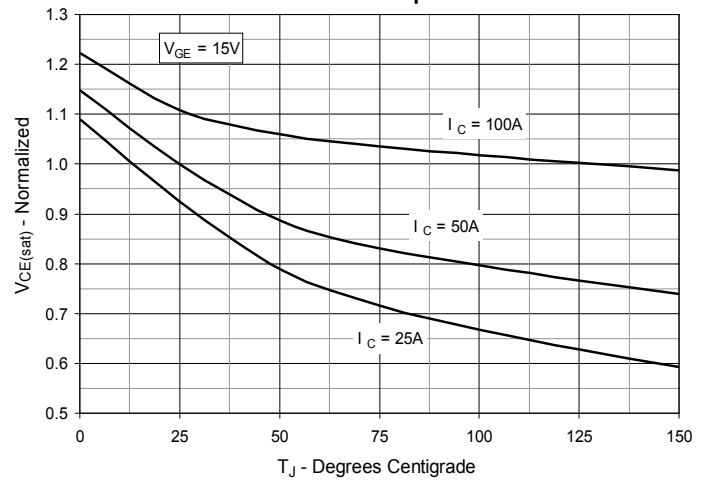
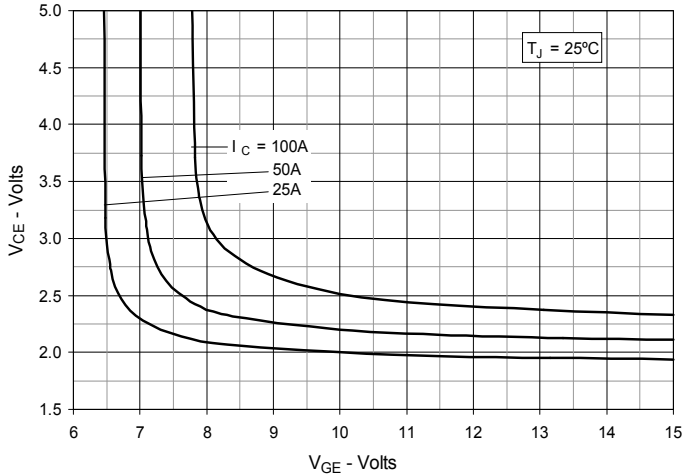
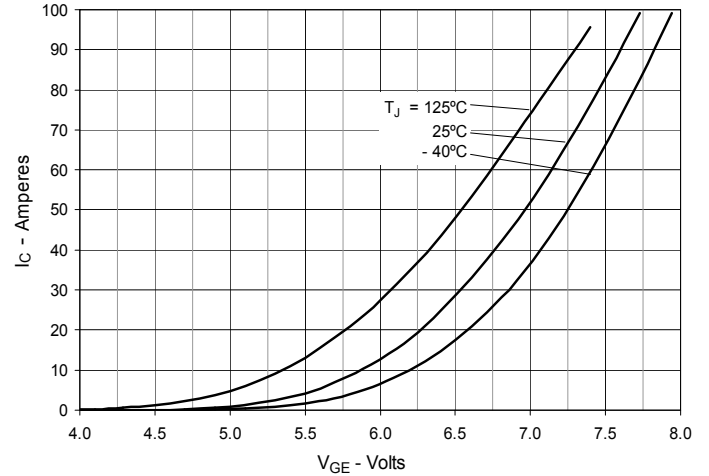
Fig. 6. Input Admittance

Fig. 7. Transconductance

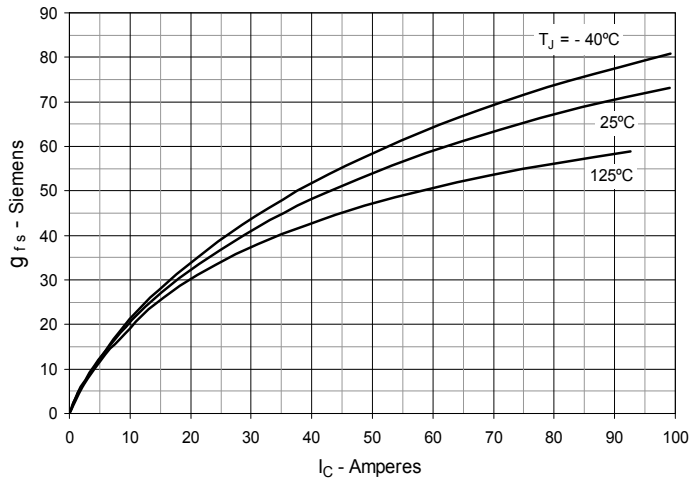

Fig. 8. Gate Charge

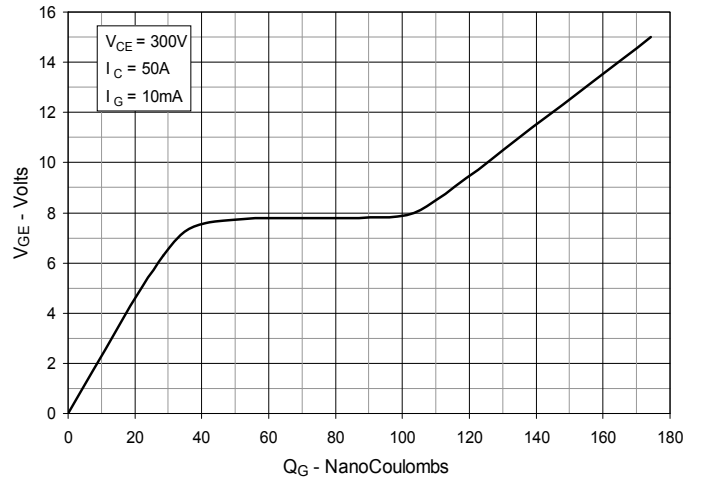

Fig. 9. Capacitance

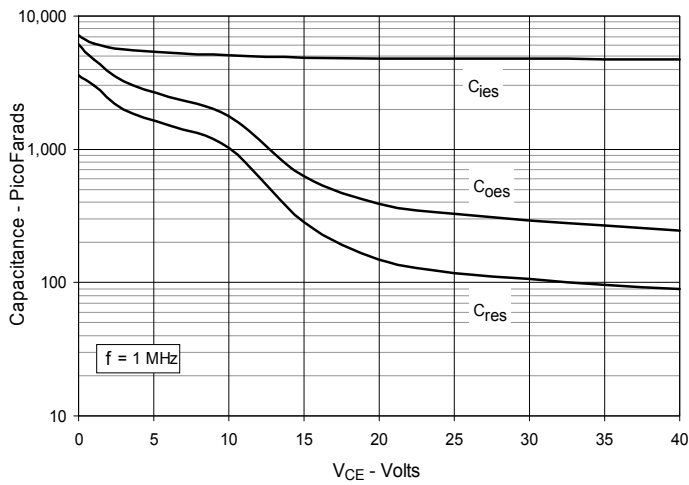

Fig. 10. Reverse-Bias Safe Operating Area

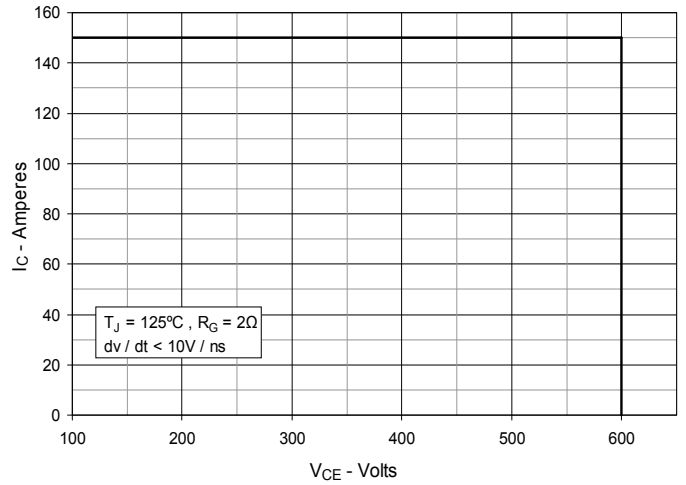
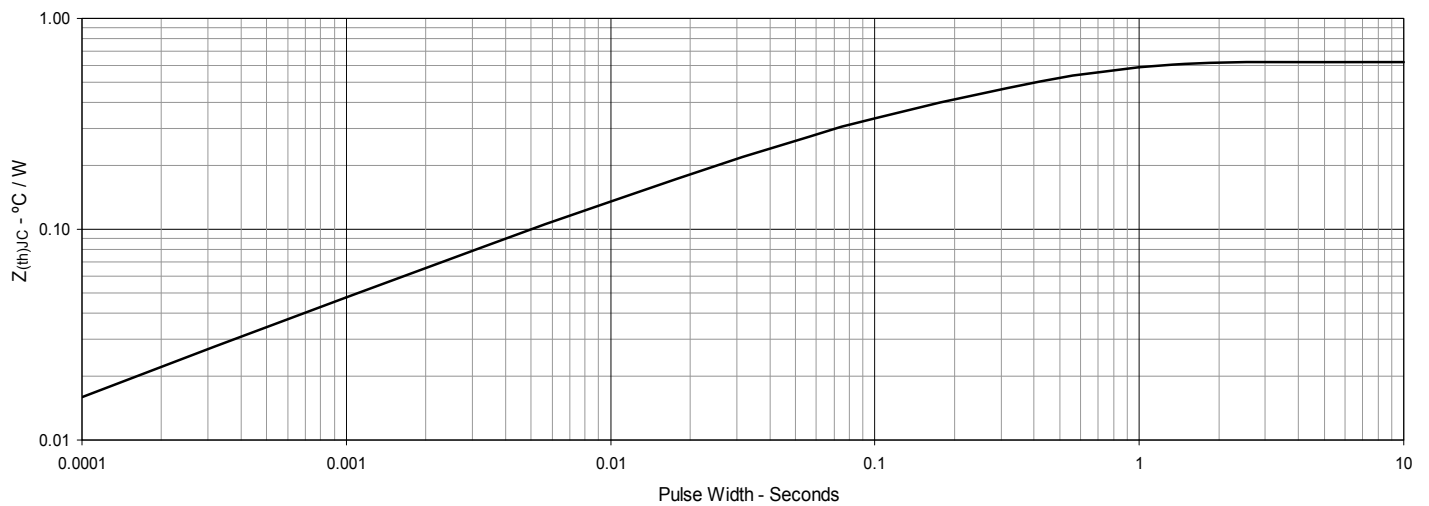
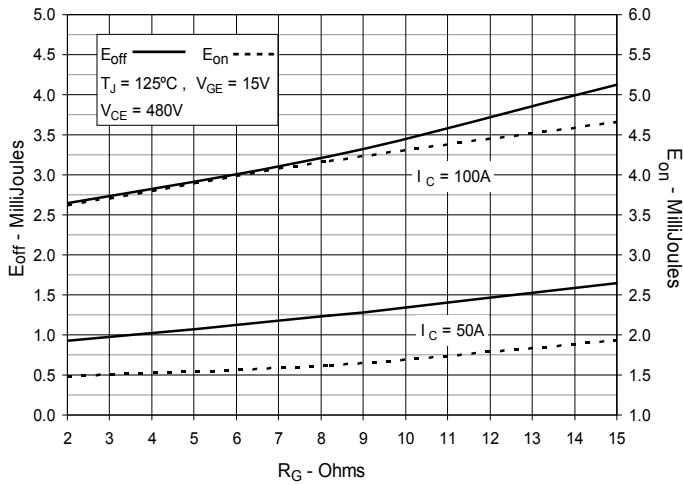
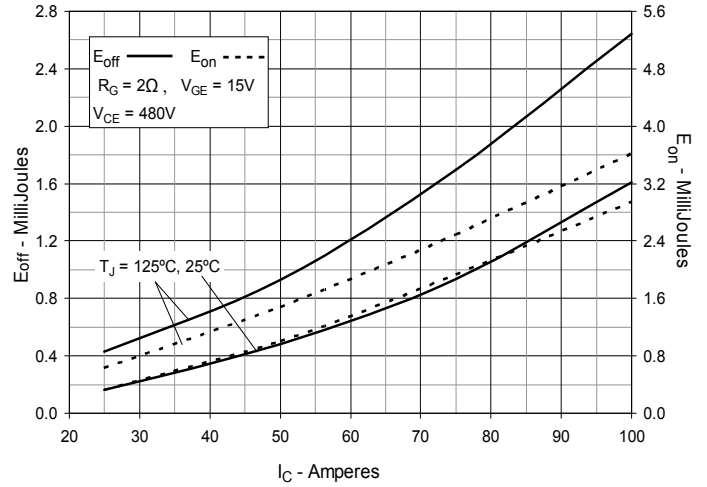
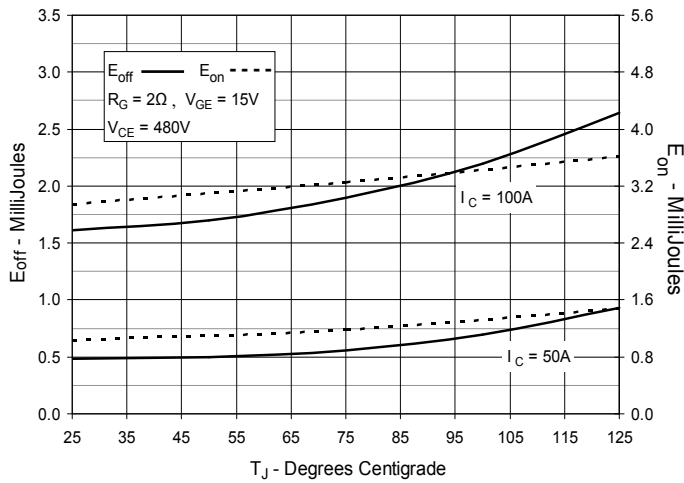
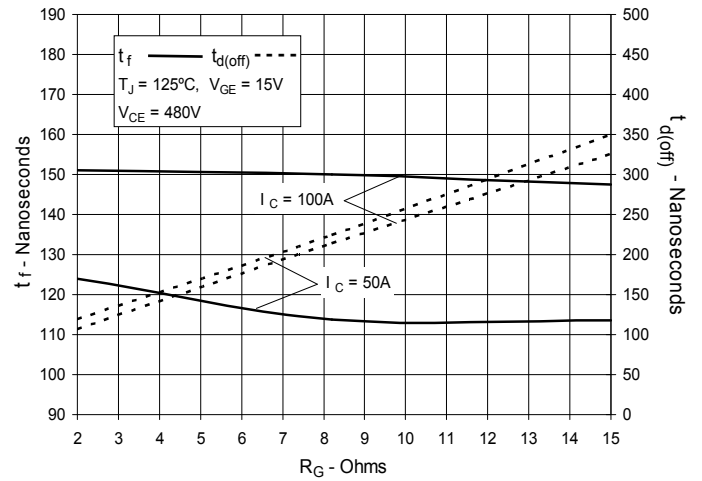
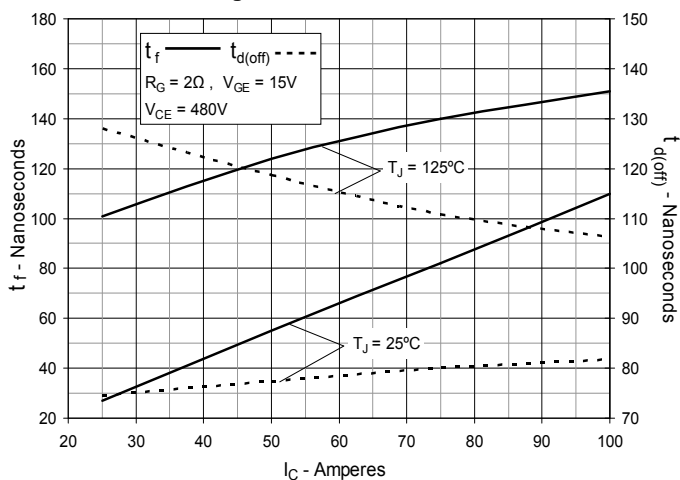
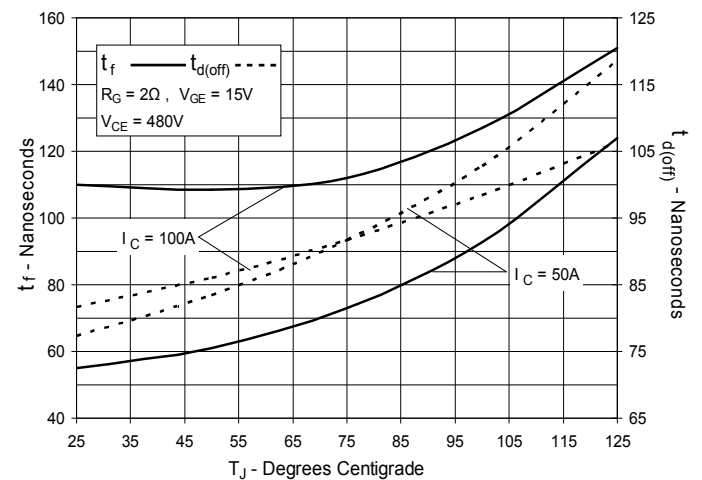
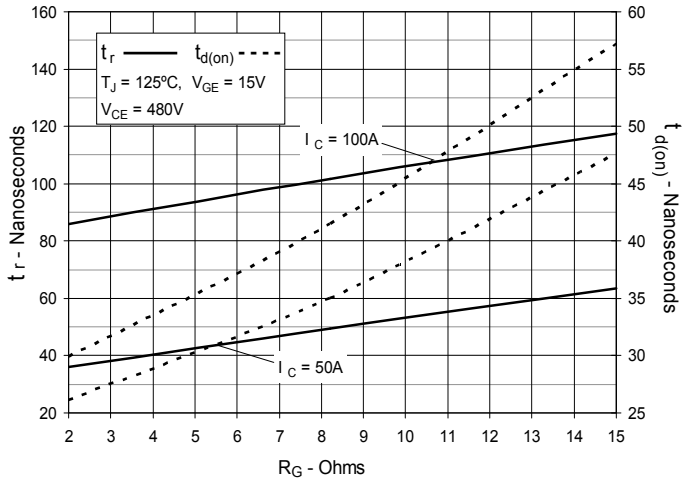

Fig. 11. Maximum Transient Thermal Impedance

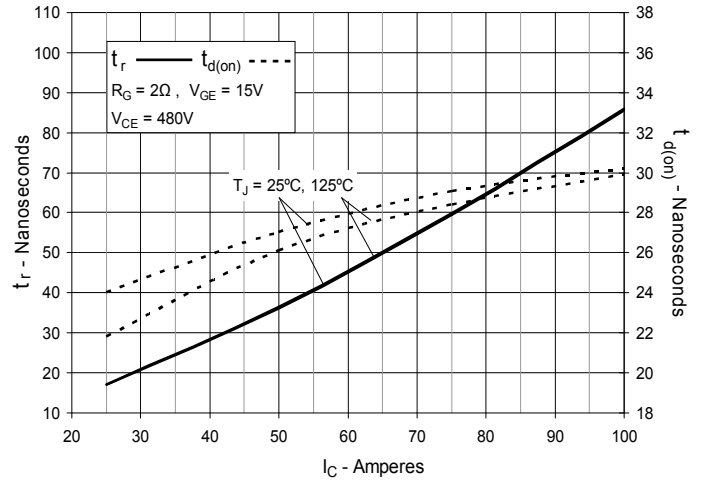

**Fig. 12. Inductive Switching
Energy Loss vs. Gate Resistance**

**Fig. 13. Inductive Switching
Energy Loss vs. Collector Current**

**Fig. 14. Inductive Switching
Energy Loss vs. Junction Temperature**

**Fig. 15. Inductive Turn-off
Switching Times vs. Gate Resistance**

**Fig. 16. Inductive Turn-off
Switching Times vs. Collector Current**

**Fig. 17. Inductive Turn-off
Switching Times vs. Junction Temperature**

**Fig. 18. Inductive Turn-on
Switching Times vs. Gate Resistance**



**Fig. 19. Inductive Turn-on
Switching Times vs. Collector Current**



**Fig. 20. Inductive Turn-on
Switching Times vs. Junction Temperature**

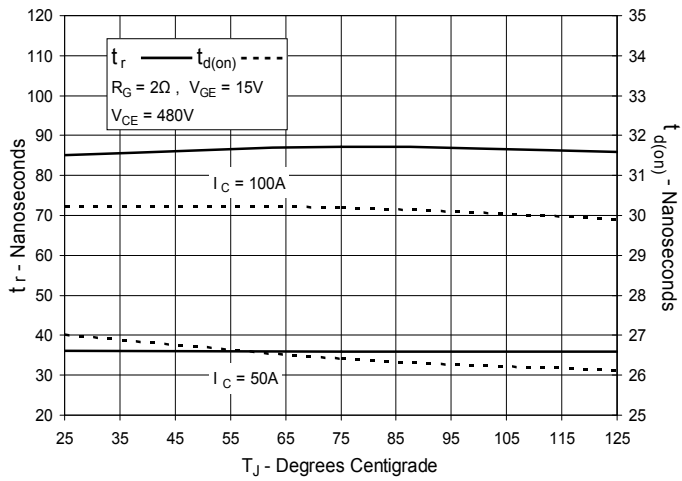

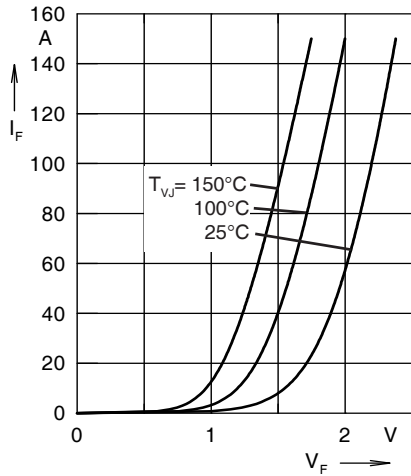

Fig. 21. Forward Current I_F Versus V_F

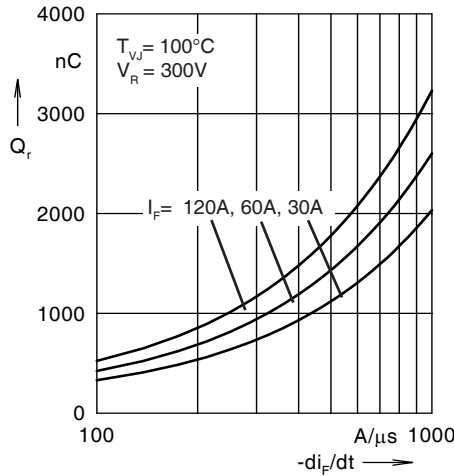

Fig. 22. Reverse Recovery Charge Q_r Versus $-di_F/dt$

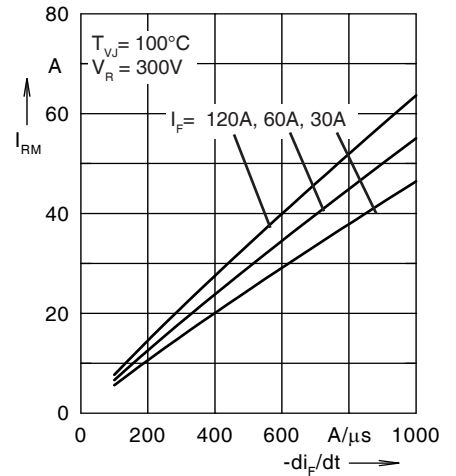

Fig. 23. Peak Reverse Current I_{RM} Versus $-di_F/dt$

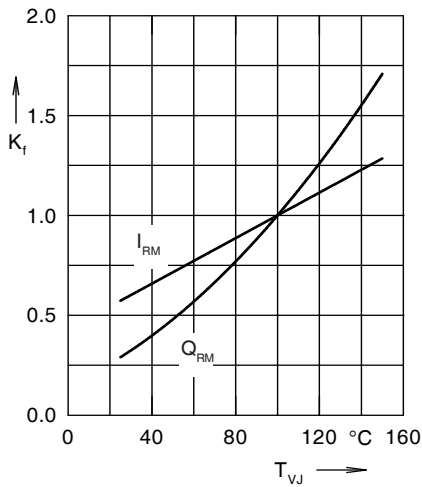

Fig. 24. Dynamic parameters Q_r, I_{RM} Versus T_{VJ}

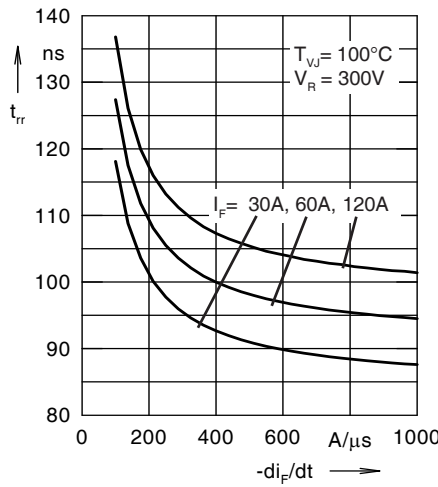

Fig. 25. Recovery Time t_{rr} Versus $-di_F/dt$

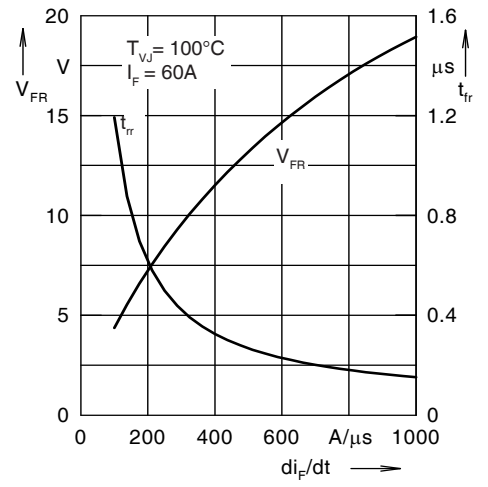

Fig. 26. Peak Forward Voltage V_{FR} and t_{rr} Versus $-di_F/dt$

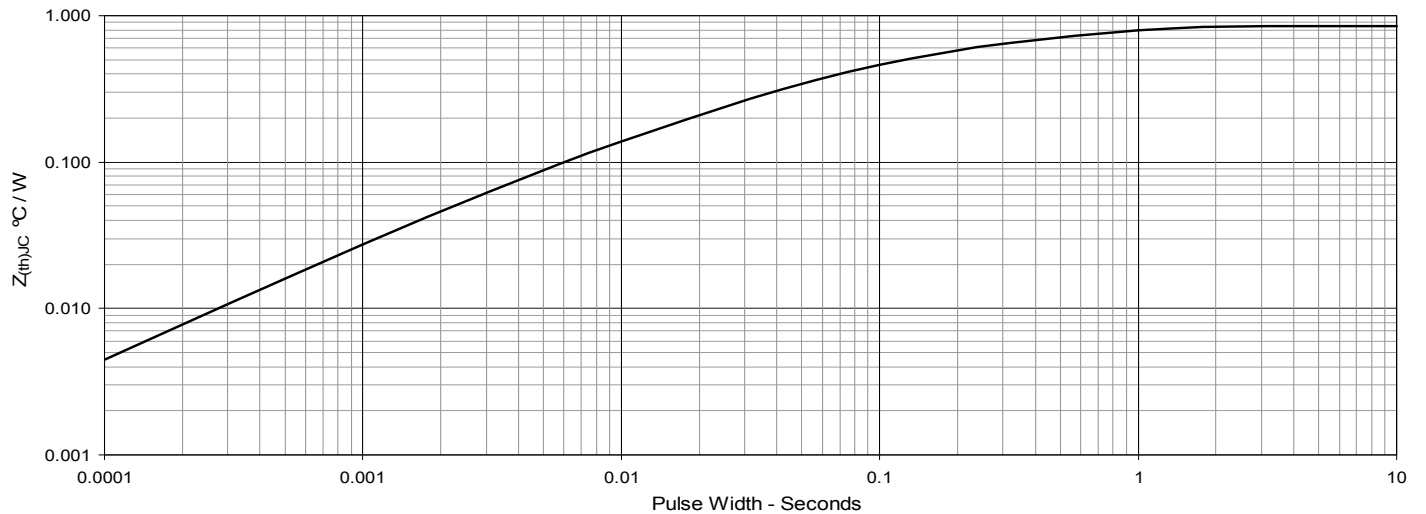

Fig. 27. Maximum Transient Thermal Impedance (for diode)



Disclaimer Notice - Information furnished is believed to be accurate and reliable. However, users should independently evaluate the suitability of and test each product selected for their own applications. Littelfuse products are not designed for, and may not be used in, all applications. Read complete Disclaimer Notice at www.littelfuse.com/disclaimer-electronics.