

High Voltage IGBT

IXGR6N170A

(Electrically Isolated Tab)

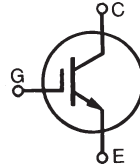

$$V_{CES} = 1700V$$

$$I_{C25} = 5.5A$$

$$V_{CE(sat)} \leq 7.0V$$

$$t_{fi(typ)} = 32ns$$

Symbol	Test Conditions	Maximum Ratings	
V_{CES}	$T_C = 25^\circ C$ to $150^\circ C$	1700	V
V_{CGR}	$T_J = 25^\circ C$ to $150^\circ C$, $R_{GE} = 1M\Omega$	1700	V
V_{GES}	Continuous	± 20	V
V_{GEM}	Transient	± 30	V
I_{C25}	$T_C = 25^\circ C$	5.5	A
I_{C110}	$T_C = 110^\circ C$	2.5	A
I_{CM}	$T_C = 25^\circ C$, 1ms	18	A
SSOA	$V_{GE} = 15V$, $T_{VJ} = 125^\circ C$, $R_G = 33\Omega$	$I_{CM} = 12$	A
(RBSOA)	Clamped Inductive Load	@ $0.8 \cdot V_{CES}$	
t_{SC}	$T_J = 125^\circ C$, $V_{CE} = 1200V$, $V_{GE} = 15V$, $R_G = 33\Omega$	10	μs
P_C	$T_C = 25^\circ C$	50	W
T_J		- 55 ... +150	$^\circ C$
T_{JM}		150	$^\circ C$
T_{stg}		- 55 ... +150	$^\circ C$
V_{ISOL}	50/60 Hz, RMS, t = 1minute $I_{ISOL} < 1mA$ t = 20 seconds	2500 3000	V~ V~
F_C	Mounting Force	20..120/4.5..27	N/lb
T_L	Maximum Lead Temperature for Soldering	300	$^\circ C$
T_{SOLD}	1.6mm (0.062 in.) from Case for 10s	260	$^\circ C$
Weight		5	g

ISOPLUS247™

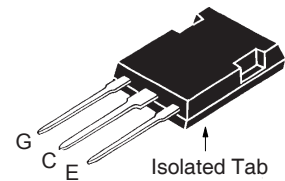

G = Gate C = Collector
E = Emitter

Features

- Silicon Chip on Direct-Copper Bond (DCB) Substrate
- Isolated Mounting Surface
- 2500V~ Electrical Isolation

Advantages

- High Power Density
- Low Gate Drive Requirement

Applications

- Power Inverters
- UPS
- Motor Drives
- SMPS
- PFC Circuits
- Welding Machines

Symbol	Test Conditions ($T_J = 25^\circ C$ Unless Otherwise Specified)	Characteristic Values		
		Min.	Typ.	Max.
BV_{CES}	$I_C = 250\mu A$, $V_{GE} = 0V$	1700		V
$V_{GE(th)}$	$I_C = 250\mu A$, $V_{CE} = V_{GE}$	3.0		5.0 V
I_{CES}	$V_{CE} = 0.8 \cdot V_{CES}$, $V_{GE} = 0V$ Note 2, $T_J = 125^\circ C$			10 μA 500 μA
I_{GES}	$V_{CE} = 0V$, $V_{GE} = \pm 20V$			± 100 nA
$V_{CE(sat)}$	$I_C = 3A$, $V_{GE} = 15V$, Note 1 $T_J = 125^\circ C$		5.4	7.0 V V

Symbol	Test Conditions ($T_J = 25^\circ\text{C}$, Unless Otherwise Specified)	Characteristic Values		
		Min.	Typ.	Max.
g_{fs}	$I_C = 6\text{A}$, $V_{CE} = 20\text{V}$, Note 1	2.0	3.5	S
C_{ies}	$V_{CE} = 25\text{V}$, $V_{GE} = 0\text{V}$, $f = 1\text{MHz}$		390	pF
C_{oes}			20	pF
C_{res}			7	pF
Q_g	$I_C = 6\text{A}$, $V_{GE} = 15\text{V}$, $V_{CE} = 0.5 \cdot V_{CES}$		18.5	nC
Q_{ge}			2.8	nC
Q_{gc}			8.2	nC
$t_{d(on)}$	Inductive load, $T_J = 25^\circ\text{C}$ $I_C = 6\text{A}$, $V_{GE} = 15\text{V}$ $V_{CE} = 0.5 \cdot V_{CES}$, $R_G = 33\Omega$ Note 3		46	ns
t_{ri}			40	ns
E_{on}			0.59	mJ
$t_{d(off)}$			220	400 ns
t_{fi}			32	65 ns
E_{off}			0.18	0.36 mJ
$t_{d(on)}$	Inductive load, $T_J = 125^\circ\text{C}$ $I_C = 6\text{A}$, $V_{GE} = 15\text{V}$ $V_{CE} = 0.5 \cdot V_{CES}$, $R_G = 33\Omega$ Note 3		48	ns
t_{ri}			43	ns
E_{on}			0.62	mJ
$t_{d(off)}$			230	ns
t_{fi}			41	ns
E_{off}			0.25	mJ
R_{thJC}			2.5	$^\circ\text{C/W}$
R_{thCK}		0.15		$^\circ\text{C/W}$

ISOPLUS247 (IXGR) Outline

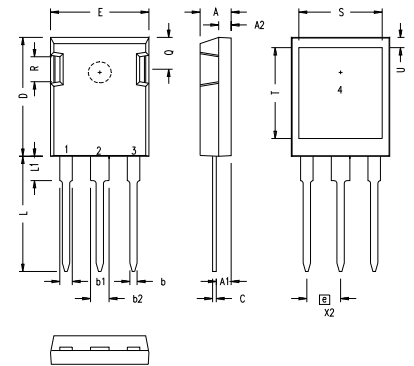

SYM	INCHES		MILLIMETERS	
	MIN	MAX	MIN	MAX
A	.190	.205	4.83	5.21
A1	.090	.100	2.29	2.54
A2	.075	.085	1.91	2.16
b	.045	.055	1.14	1.40
b1	.075	.084	1.91	2.13
b2	.115	.123	2.92	3.12
C	.024	.031	0.61	0.80
D	.819	.840	20.80	21.34
E	.620	.635	15.75	16.13
e	.215 BSC		5.45 BSC	
L	.780	.800	19.81	20.32
L1	.150	.170	3.81	4.32
Q	.220	.244	5.59	6.20
R	.170	.190	4.32	4.83
S	.520	.540	13.21	13.72
T	.620	.640	15.75	16.26
U	.065	.080	1.65	2.03

- 1 - GATE
- 2 - DRAIN (COLLECTOR)
- 3 - SOURCE (EMITTER)
- 4 - NO CONNECTION

NOTE: This drawing will meet all dimensions requirement of JEDEC outline TO-247AD except screw hole.

Notes:

1. Pulse test, $t \leq 300\mu\text{s}$, duty cycle, $d \leq 2\%$.
2. Part must be heatsunk for high-temp I_{ces} measurement.
3. Switching times & energy losses may increase for higher $V_{CE(Clamp)}$, T_J or R_G .

ADVANCE TECHNICAL INFORMATION

The product presented herein is under development. The Technical Specifications offered are derived from a subjective evaluation of the design, based upon prior knowledge and experience, and constitute a "considered reflection" of the anticipated result. IXYS reserves the right to change limits, test conditions, and dimensions without notice.

IXYS Reserves the Right to Change Limits, Test Conditions, and Dimensions.

IXYS MOSFETs and IGBTs are covered by one or more of the following U.S. patents:	4,835,592	4,931,844	5,049,961	5,237,481	6,162,665	6,404,065 B1	6,683,344	6,727,585	7,005,734 B2	7,157,338B2
	4,850,072	5,017,508	5,063,307	5,381,025	6,259,123 B1	6,534,343	6,710,405 B2	6,759,692	7,063,975 B2	
	4,881,106	5,034,796	5,187,117	5,486,715	6,306,728 B1	6,583,505	6,710,463	6,771,478 B2	7,071,537	

Fig. 1. Output Characteristics @ $T_J = 25^\circ\text{C}$

Fig. 2. Extended Output Characteristics @ $T_J = 25^\circ\text{C}$

Fig. 3. Output Characteristics @ $T_J = 125^\circ\text{C}$

Fig. 4. Dependence of $V_{CE(sat)}$ on Junction Temperature

Fig. 5. Collector-to-Emitter Voltage vs. Gate-to-Emitter Voltage

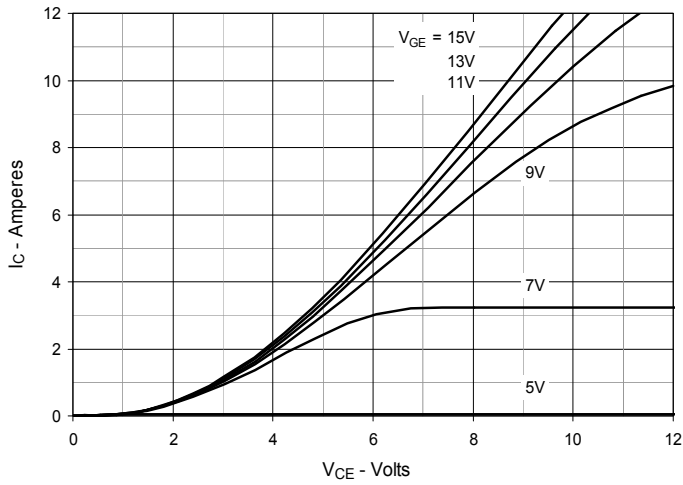
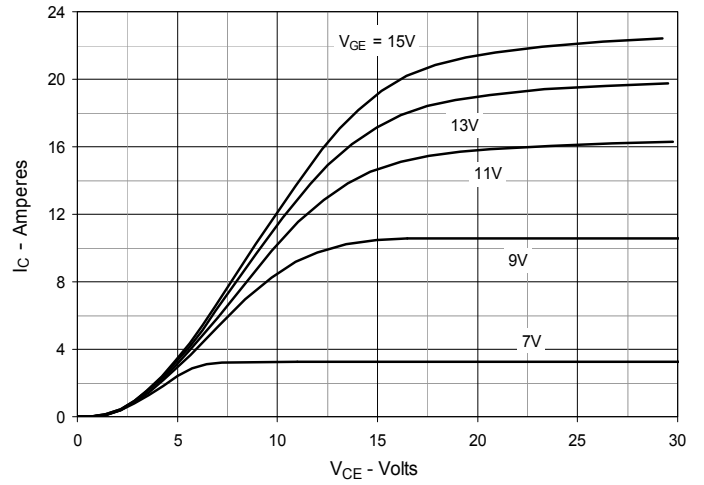
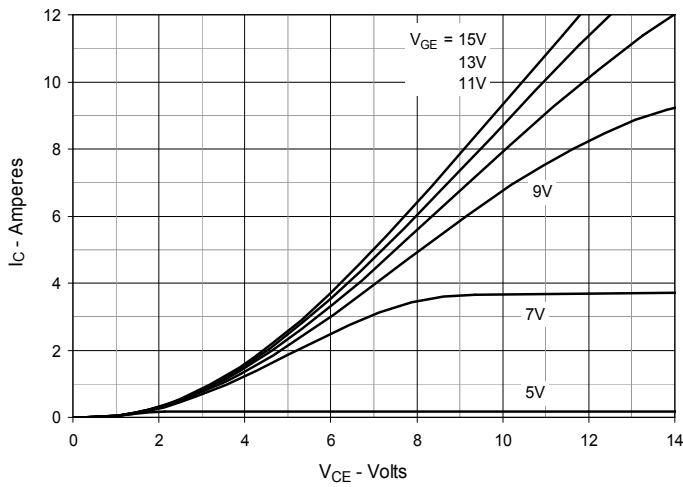
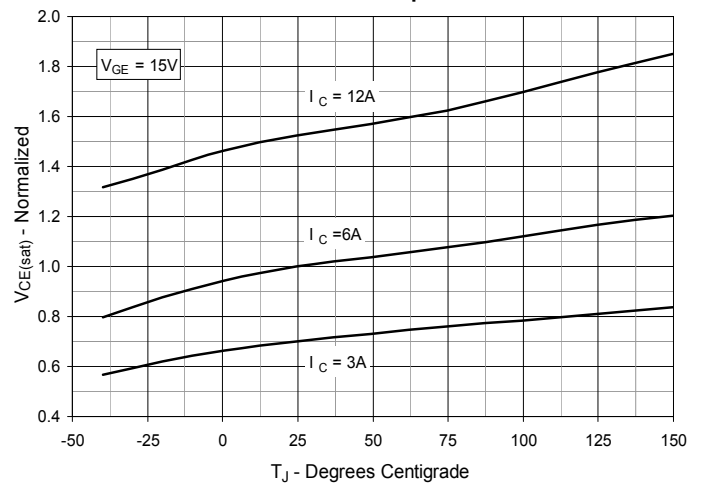
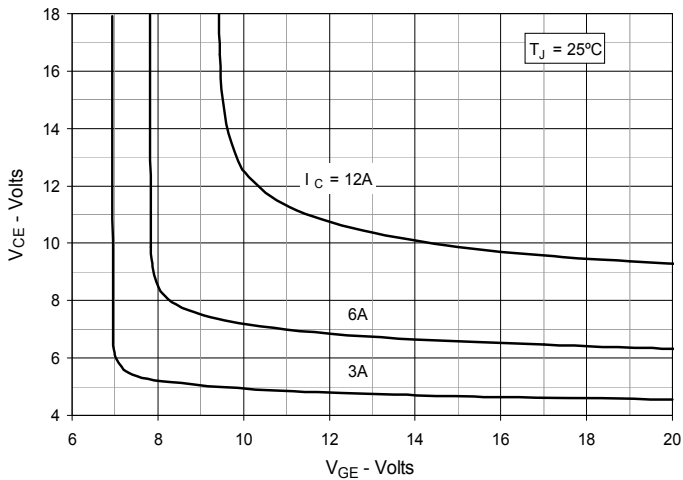
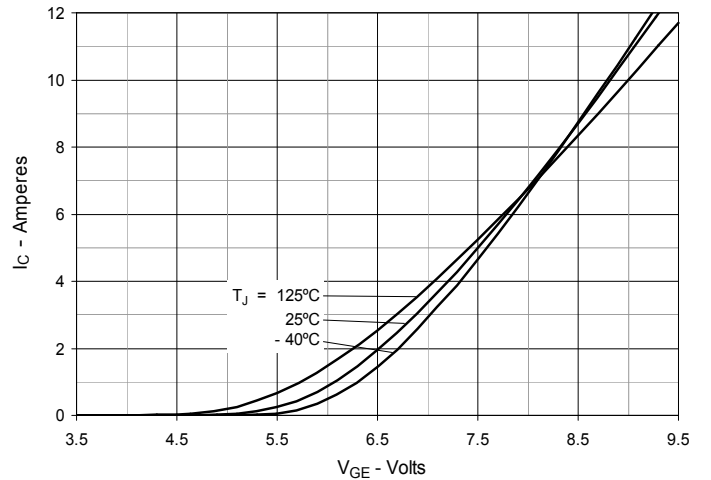
Fig. 6. Input Admittance

Fig. 7. Transconductance

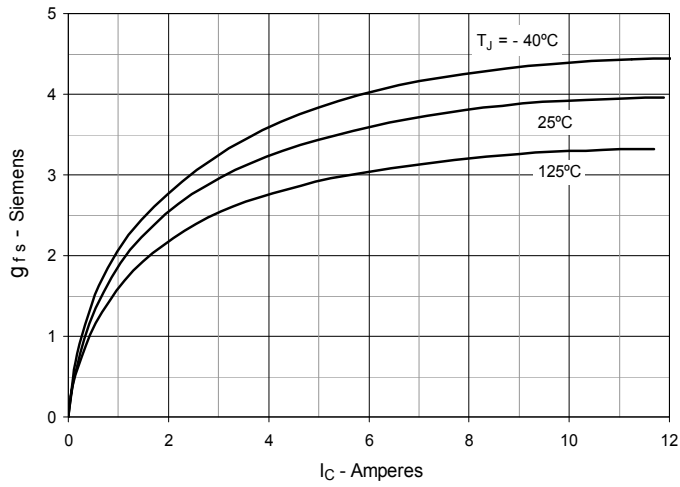

Fig. 8. Gate Charge

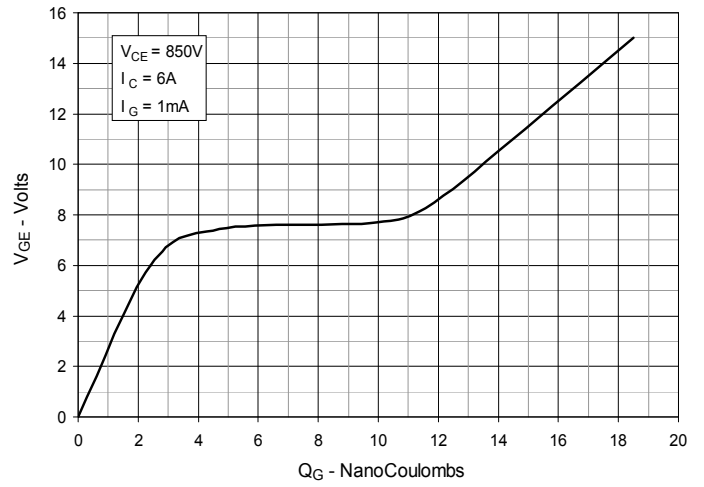

Fig. 9. Reverse-Bias Safe Operating Area

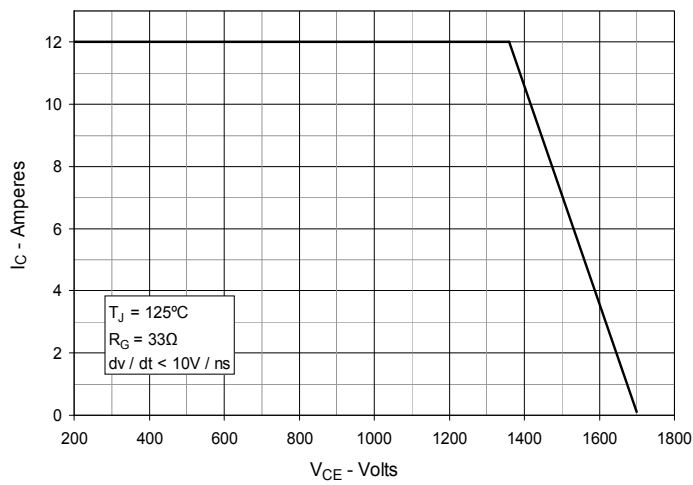

Fig. 10. Capacitance

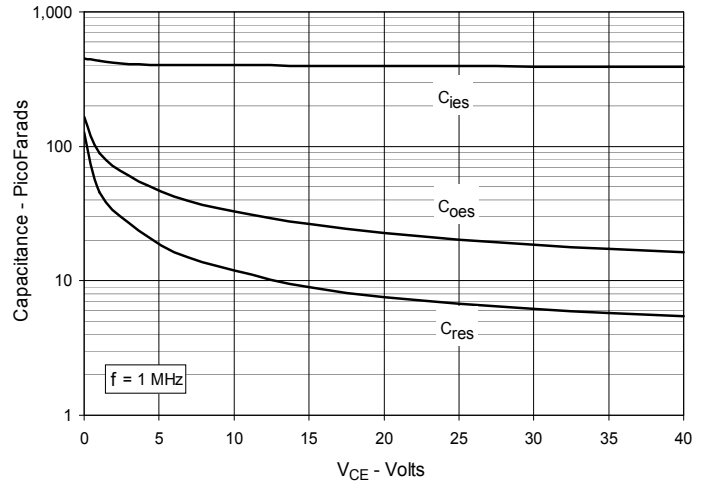

Fig. 11. Maximum Transient Thermal Impedance

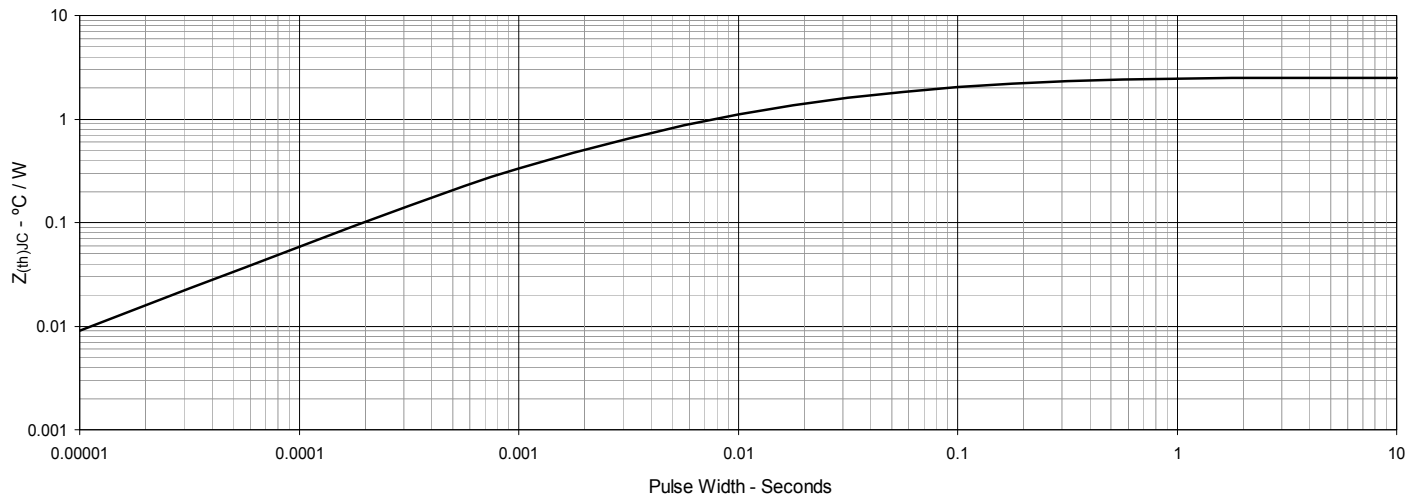

Fig. 12. Inductive Switching Energy Loss vs. Gate Resistance

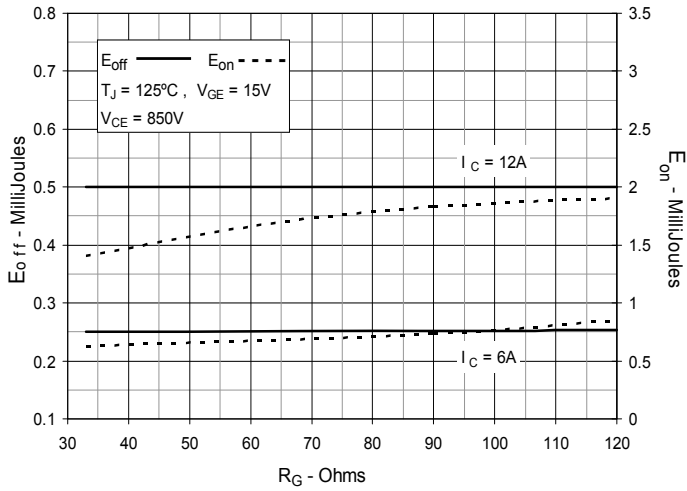

Fig. 13. Inductive Switching Energy Loss vs. Collector Current

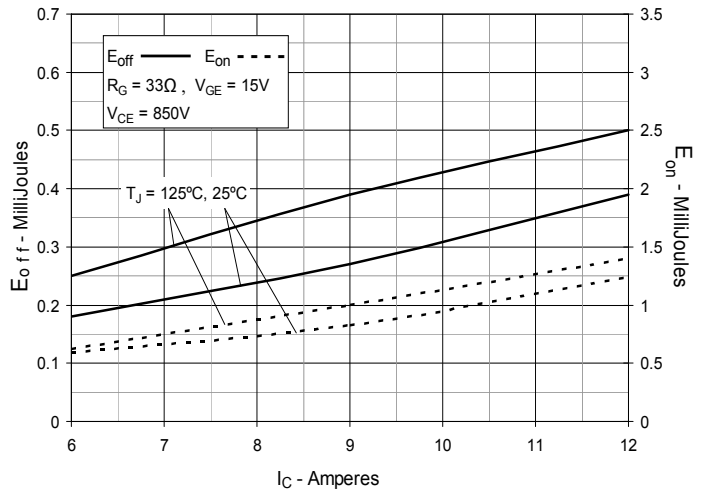
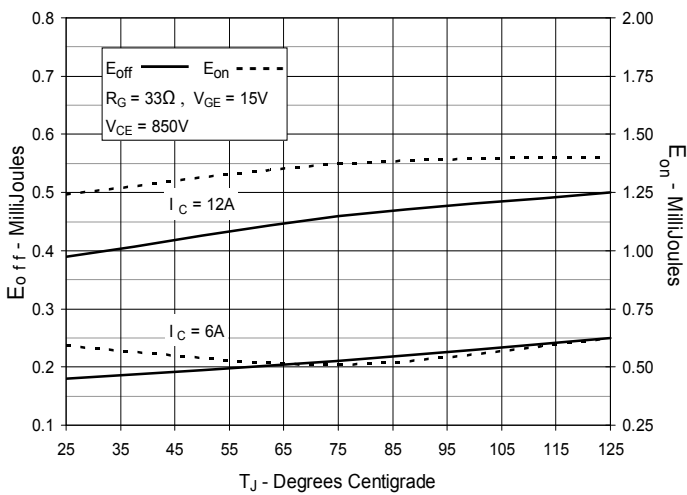

Fig. 14. Inductive Switching Energy Loss vs. Junction Temperature





Disclaimer Notice - Information furnished is believed to be accurate and reliable. However, users should independently evaluate the suitability of and test each product selected for their own applications. Littelfuse products are not designed for, and may not be used in, all applications. Read complete Disclaimer Notice at www.littelfuse.com/disclaimer-electronics.