

GenX3™ 600V IGBT w/ Diode

IXGR60N60C3D1

(Electrically Isolated Back Surface)

High Speed PT IGBT for
40-100 kHz Switching

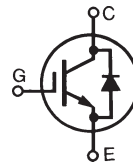

$$V_{CES} = 600V$$

$$I_{C110} = 30A$$

$$V_{CE(sat)} \leq 2.5V$$

$$t_{fi(typ)} = 50ns$$

Symbol	Test Conditions	Maximum Ratings	
V_{CES}	$T_J = 25^\circ C$ to $150^\circ C$	600	V
V_{CGR}	$T_J = 25^\circ C$ to $150^\circ C$, $R_{GE} = 1M\Omega$	600	V
V_{GES}	Continuous	± 20	V
V_{GEM}	Transient	± 30	V
I_{C25}	$T_C = 25^\circ C$ (Limited by Leads)	75	A
I_{C110}	$T_C = 110^\circ C$	30	A
I_{F110}	$T_C = 110^\circ C$	17	A
I_{CM}	$T_C = 25^\circ C$, 1ms	260	A
I_A	$T_C = 25^\circ C$	40	A
E_{AS}	$T_C = 25^\circ C$	400	mJ
SSOA (RBSOA)	$V_{GE} = 15V$, $T_{VJ} = 125^\circ C$, $R_G = 3\Omega$ Clamped Inductive Load	$I_{CM} = 125$ $V_{CE} \leq V_{CES}$	A
P_C	$T_C = 25^\circ C$	170	W
T_J		-55 ... +150	$^\circ C$
T_{JM}		150	$^\circ C$
T_{stg}		-55 ... +150	$^\circ C$
V_{ISOL}	50/60 Hz, RMS, $t = 1$ minute $I_{ISOL} < 1mA$ $t = 10$ s	2500 3000	V~ V~
F_C	Mounting Force	20..120/4.5..27	N/lb
T_L	Maximum Lead Temperature for Soldering	300	$^\circ C$
T_{SOLD}	1.6mm (0.062 in.) from Case for 10s	260	$^\circ C$
Weight		5	g

ISOPLUS247™

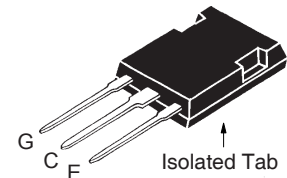

G = Gate C = Collector
E = Emitter

Features

- Silicon Chip on Direct-Copper Bond (DCB) Substrate
- Isolated Mounting Surface
- 2500V Electrical Isolation
- Optimized for Low Switching Losses
- Square RBSOA
- Avalanche Rated
- Anti-Parallel Ultra Fast Diode

Advantages

- High Power Density
- Low Gate Drive Requirement

Applications

- High Frequency Power Inverters
- UPS
- Motor Drives
- SMPS
- PFC Circuits
- Battery Chargers
- Welding Machines
- Lamp Ballasts

Symbol	Test Conditions ($T_J = 25^\circ C$, Unless Otherwise Specified)	Characteristic Values		
		Min.	Typ.	Max.
$V_{GE(th)}$	$I_C = 250\mu A$, $V_{CE} = V_{GE}$	3.0		5.5 V
I_{CES}	$V_{CE} = V_{CES}$, $V_{GE} = 0V$ $T_J = 125^\circ C$			50 μA 1 mA
I_{GES}	$V_{CE} = 0V$, $V_{GE} = \pm 20V$			± 100 nA
$V_{CE(sat)}$	$I_C = 40A$, $V_{GE} = 15V$, Note 1 $T_J = 125^\circ C$		2.2 1.7	2.5 V V

Symbol	Test Conditions ($T_J = 25^\circ\text{C}$, Unless Otherwise Specified)	Characteristic Values		
		Min.	Typ.	Max.
g_{fs}	$I_C = 40\text{A}, V_{CE} = 10\text{V}$, Note 1	23	38	S
C_{ies} C_{oes} C_{res}	$V_{CE} = 25\text{V}, V_{GE} = 0\text{V}, f = 1\text{MHz}$		2810	pF
			230	pF
			80	pF
Q_g Q_{ge} Q_{gc}	$I_C = 50\text{A}, V_{GE} = 15\text{V}, V_{CE} = 0.5 \cdot V_{CES}$		115	nC
			22	nC
			43	nC
$t_{d(on)}$ t_{ri} E_{on} $t_{d(off)}$ t_{fi} E_{off}	Inductive Load, $T_J = 25^\circ\text{C}$ $I_C = 40\text{A}, V_{GE} = 15\text{V}$ $V_{CE} = 480\text{V}, R_G = 3\Omega$ Note 2		21	ns
			33	ns
			0.80	mJ
			70	110 ns
			50	ns
			0.45	0.80 mJ
$t_{d(on)}$ t_{ri} E_{on} $t_{d(off)}$ t_{fi} E_{off}	Inductive Load, $T_J = 125^\circ\text{C}$ $I_C = 40\text{A}, V_{GE} = 15\text{V}$ $V_{CE} = 480\text{V}, R_G = 3\Omega$ Note 2		21	ns
			33	ns
			1.25	mJ
			112	ns
			86	ns
			0.80	mJ
R_{thJC} R_{thCS}		0.15	0.73 $^\circ\text{C/W}$ $^\circ\text{C/W}$	

Reverse Diode (FRED)

Symbol	Test Conditions ($T_J = 25^\circ\text{C}$, Unless Otherwise Specified)	Characteristic Values		
		Min.	Typ.	Max.
V_F	$I_F = 30\text{A}, V_{GE} = 0\text{V}$, Note 1 $T_J = 150^\circ\text{C}$		1.6	2.8 V V
I_{RM}	$I_F = 30\text{A}, V_{GE} = 0\text{V}, T_J = 100^\circ\text{C}$ $-di_F/dt = 100\text{A}/\mu\text{s}, V_R = 100\text{V}$		100	4 A ns
t_{rr}	$I_F = 1\text{A}, -di/dt = 100\text{A}/\mu\text{s}, V_R = 30\text{V}$		25	ns
R_{thJC}				1.5 $^\circ\text{C/W}$

Notes:

1. Pulse test, $t \leq 300\mu\text{s}$, duty cycle, $d \leq 2\%$.
2. Switching times & energy losses may increase for higher V_{CE} (Clamp), T_J or R_G .

ISOPLUS247 (IXGR) Outline

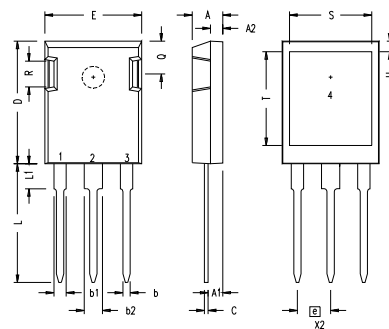

SYM	INCHES		MILLIMETERS	
	MIN	MAX	MIN	MAX
A	.190	.205	4.83	5.21
A1	.090	.100	2.29	2.54
A2	.075	.085	1.91	2.16
b	.045	.055	1.14	1.40
b1	.075	.084	1.91	2.13
b2	.115	.123	2.92	3.12
C	.024	.031	0.61	0.80
D	.819	.840	20.80	21.34
E	.620	.635	15.75	16.13
e	.215 BSC		5.45 BSC	
L	.780	.800	19.81	20.32
L1	.150	.170	3.81	4.32
Q	.220	.244	5.59	6.20
R	.170	.190	4.32	4.83
S	.520	.540	13.21	13.72
T	.620	.640	15.75	16.26
U	.065	.080	1.65	2.03

- 1 - GATE
- 2 - DRAIN (COLLECTOR)
- 3 - SOURCE (EMITTER)
- 4 - NO CONNECTION

NOTE: This drawing will meet all dimensions requirement of JEDEC outline TO-247AD except screw hole.

IXYS Reserves the Right to Change Limits, Test Conditions, and Dimensions.

IXYS MOSFETs and IGBTs are covered by one or more of the following U.S. patents:	4,835,592	4,931,844	5,049,961	5,237,481	6,162,665	6,404,065 B1	6,683,344	6,727,585	7,005,734 B2	7,157,338B2
	4,850,072	5,017,508	5,063,307	5,381,025	6,259,123 B1	6,534,343	6,710,405 B2	6,759,692	7,063,975 B2	
	4,881,106	5,034,796	5,187,117	5,486,715	6,306,728 B1	6,583,505	6,710,463	6,771,478 B2	7,071,537	

Fig. 1. Output Characteristics @ $T_J = 25^\circ\text{C}$

Fig. 2. Extended Output Characteristics @ $T_J = 25^\circ\text{C}$

Fig. 3. Output Characteristics @ $T_J = 125^\circ\text{C}$

Fig. 4. Dependence of $V_{CE(sat)}$ on Junction Temperature

Fig. 5. Collector-to-Emitter Voltage vs. Gate-to-Emitter Voltage

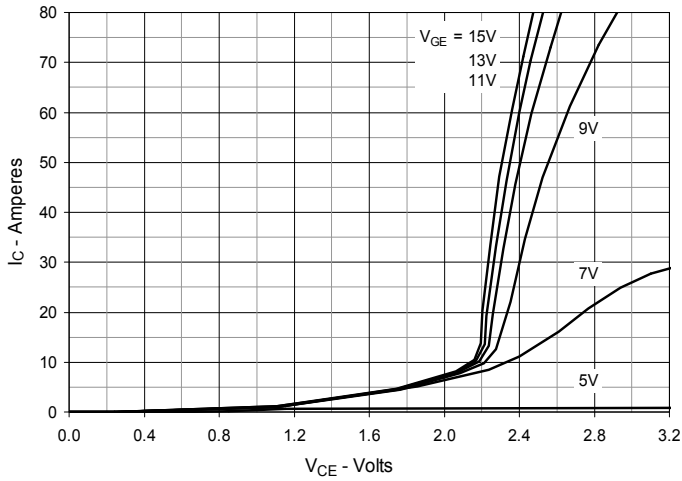
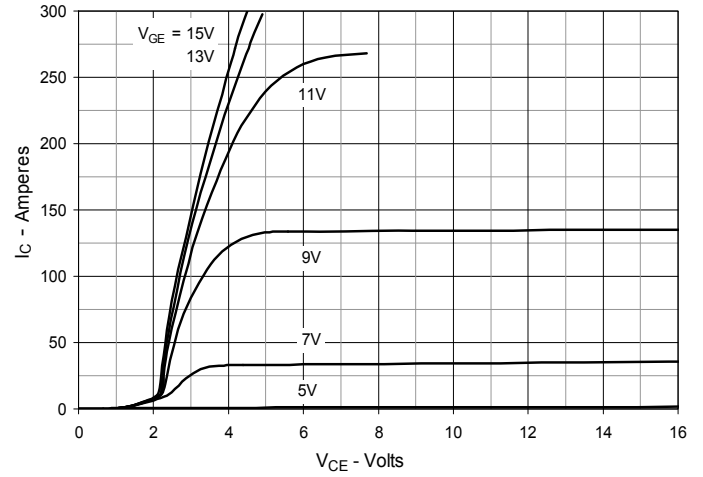
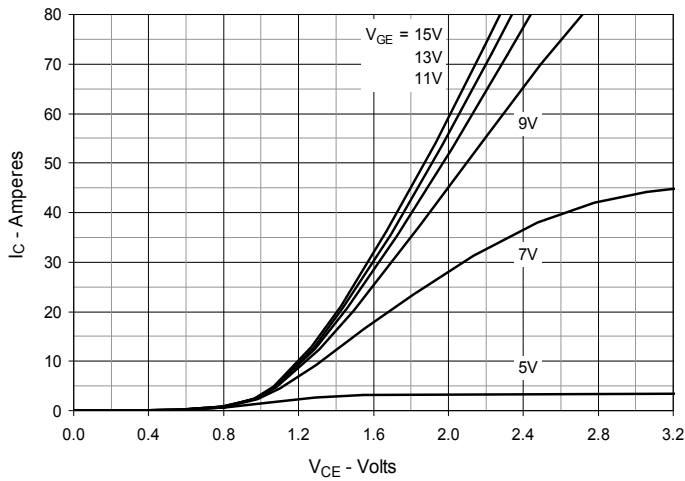
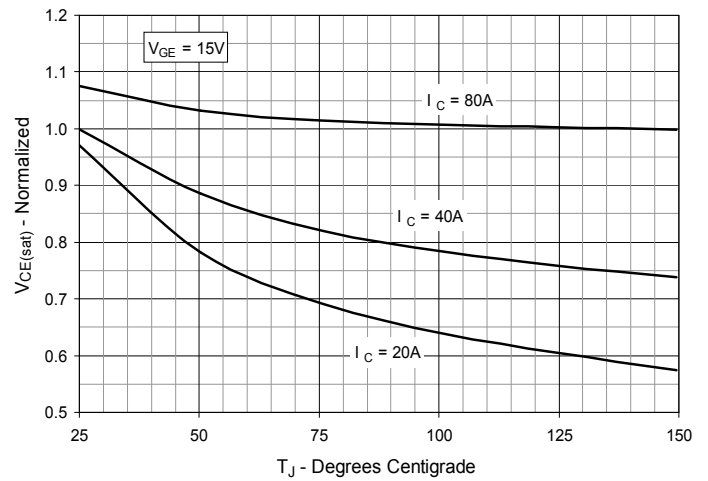
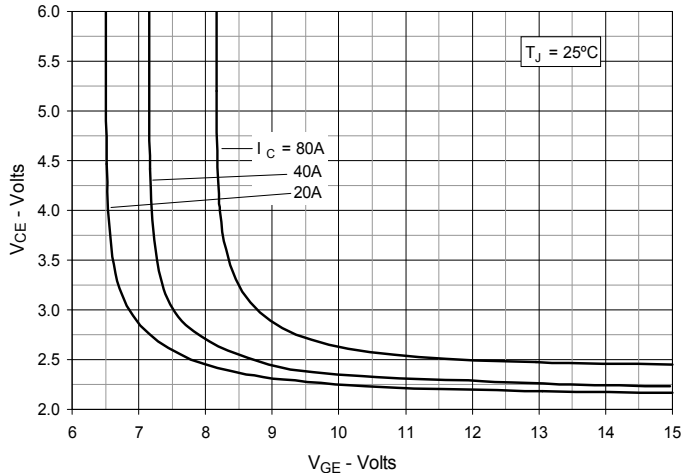
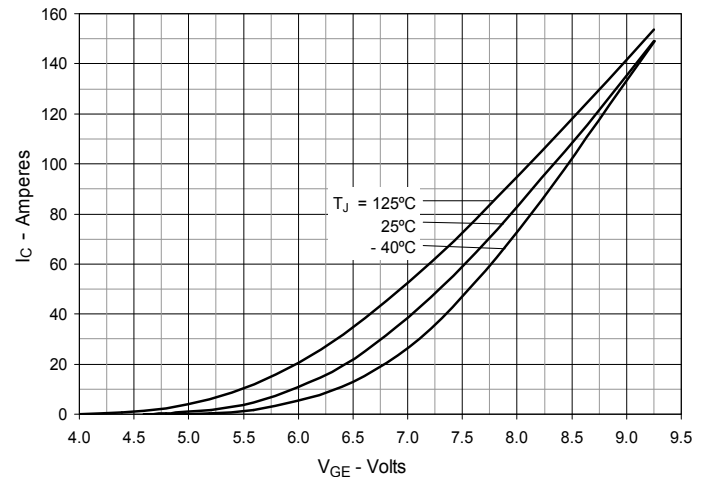
Fig. 6. Input Admittance

Fig. 7. Transconductance

Fig. 8. Gate Charge

Fig. 9. Capacitance

Fig. 10. Reverse-Bias Safe Operating Area

Fig. 11. Maximum Transient Thermal Impedance

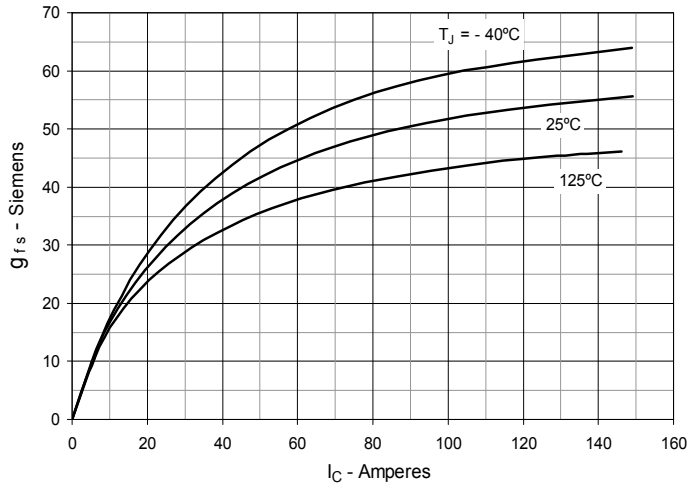
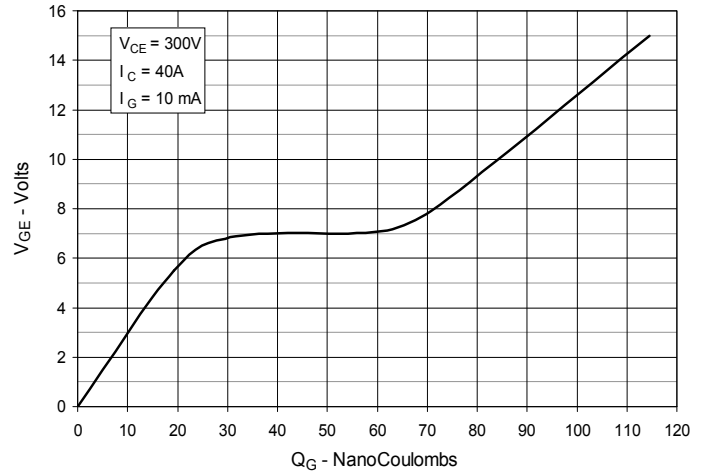
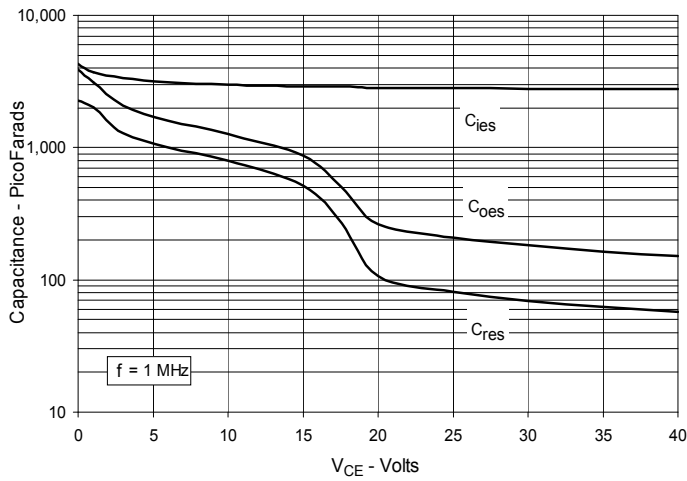
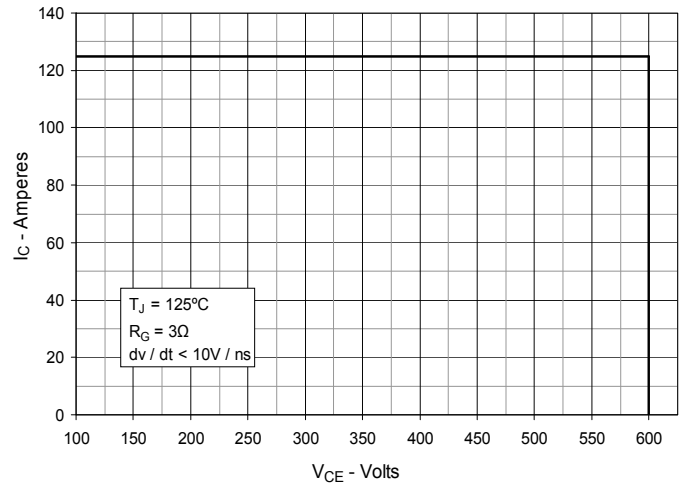
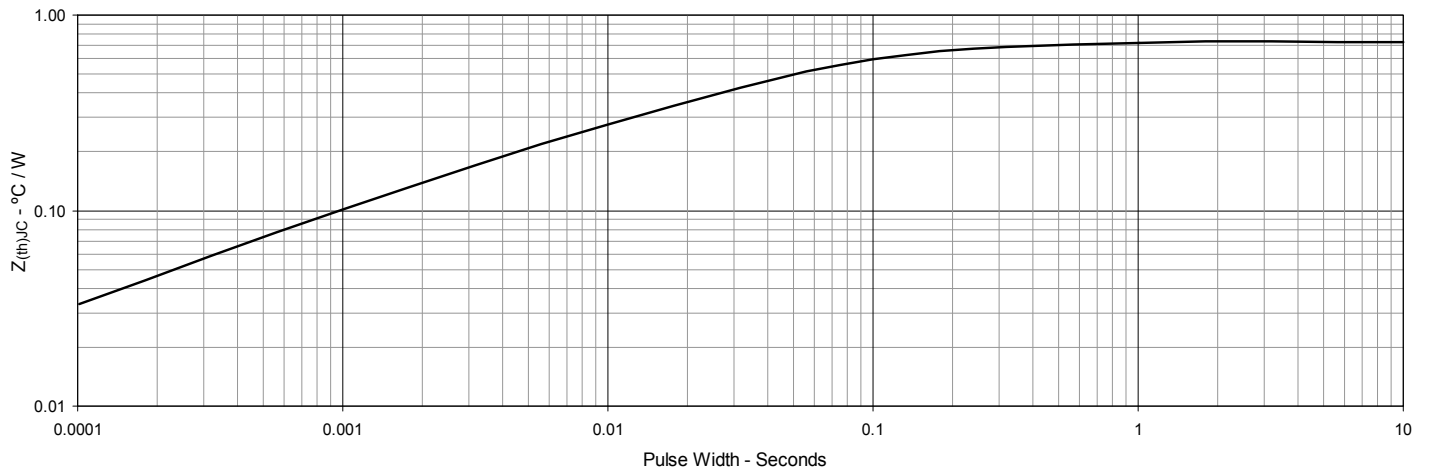
Fig. 12. Inductive Switching Energy Loss vs. Gate Resistance

Fig. 13. Inductive Switching Energy Loss vs. Collector Current

Fig. 14. Inductive Switching Energy Loss vs. Junction Temperature

Fig. 15. Inductive Turn-off Switching Times vs. Gate Resistance

Fig. 16. Inductive Turn-off Switching Times vs. Collector Current

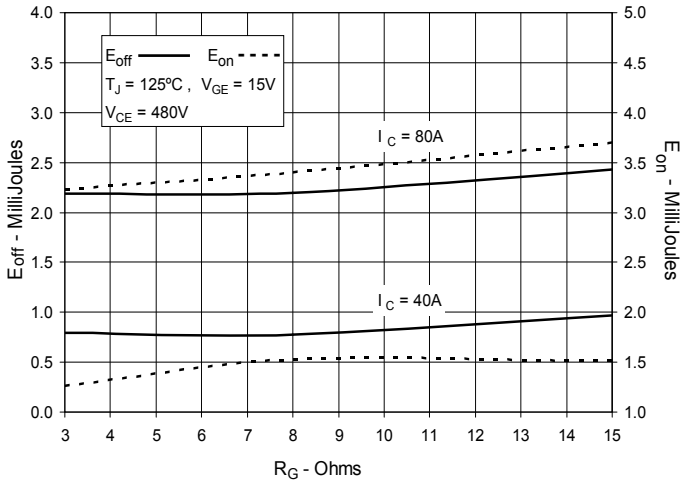
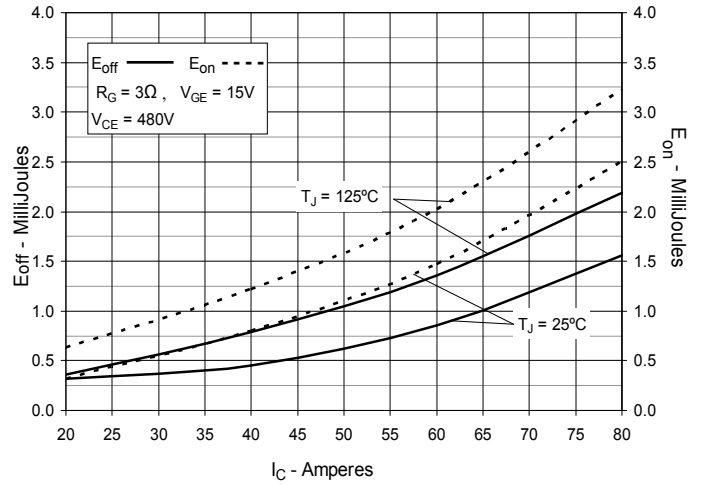
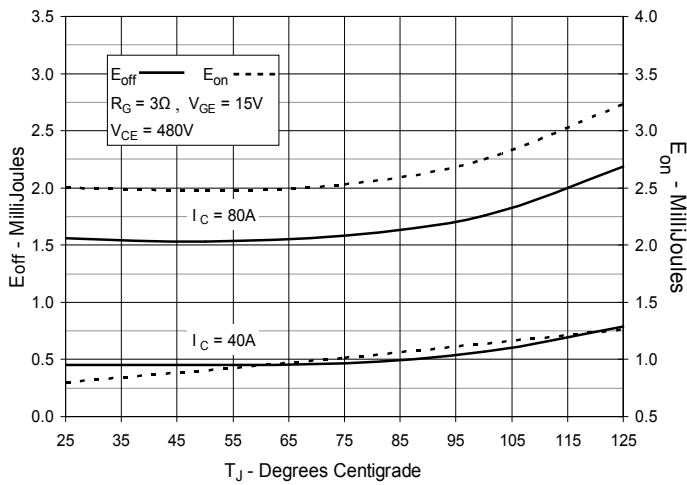
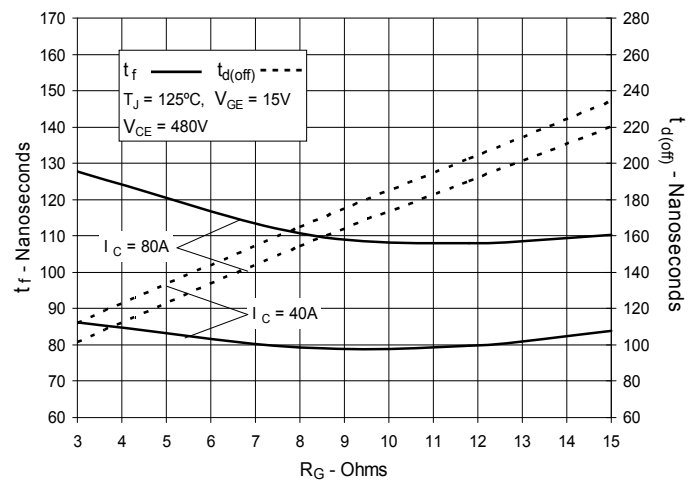
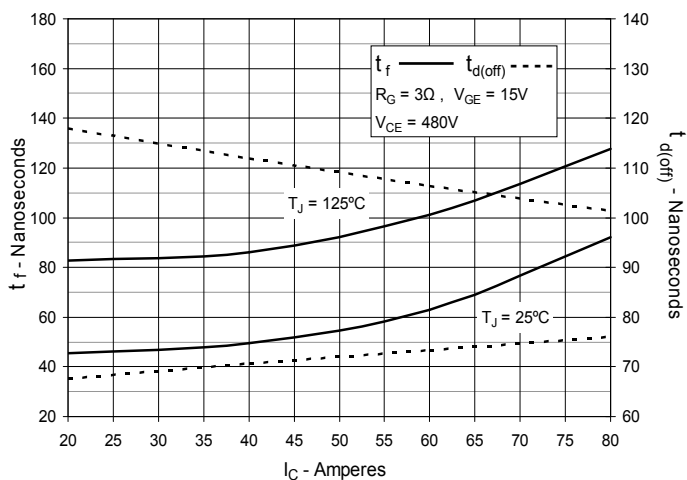
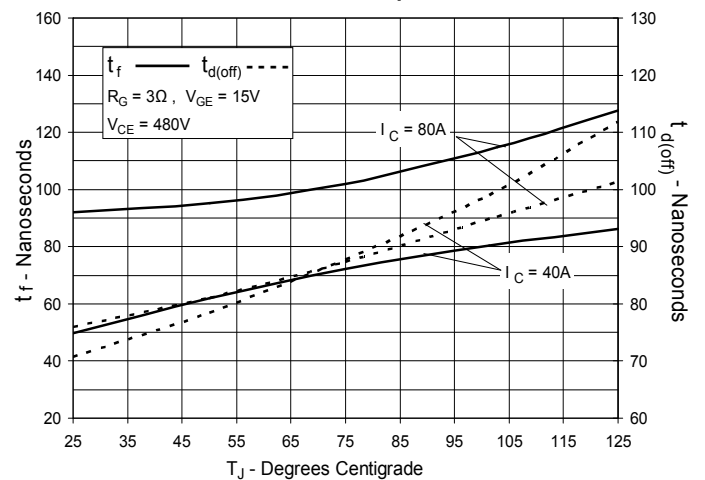
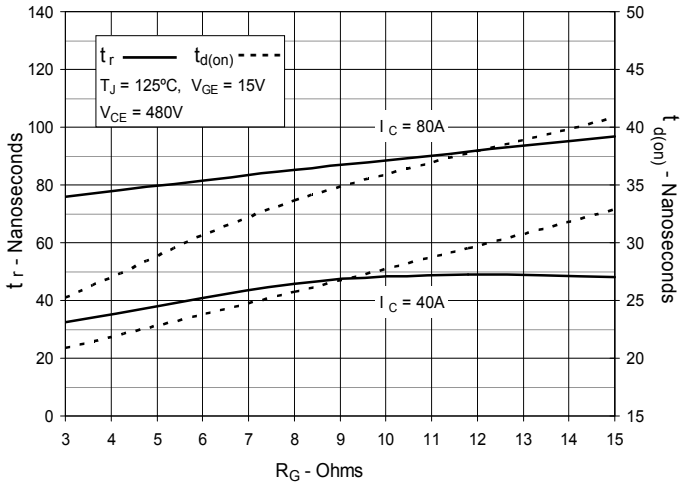
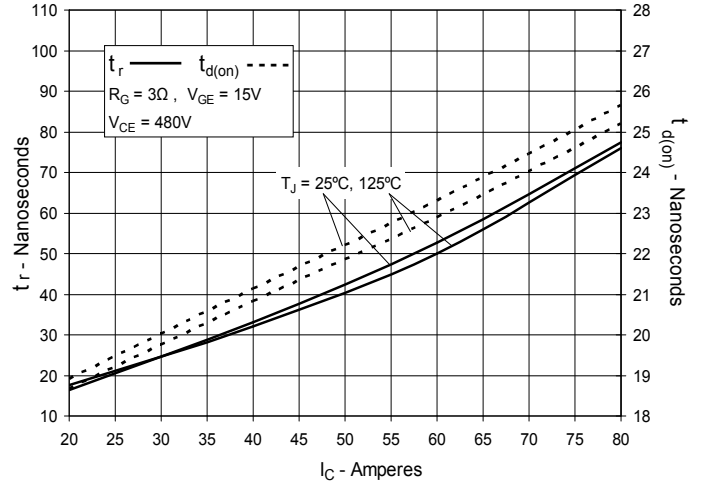
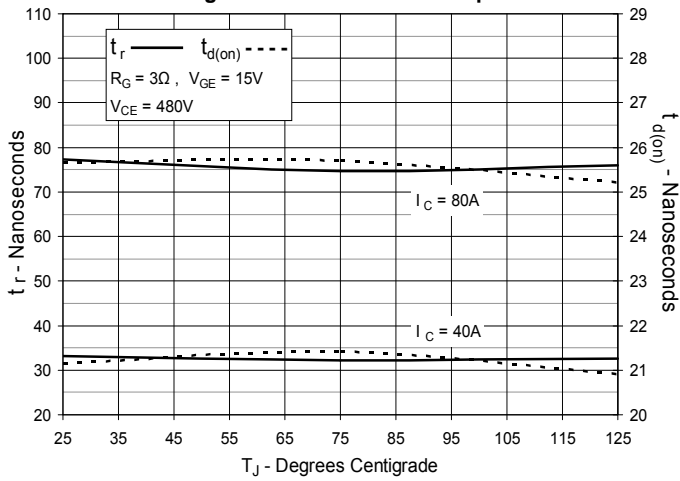
Fig. 17. Inductive Turn-off Switching Times vs. Junction Temperature

Fig. 18. Inductive Turn-on Switching Times vs. Gate Resistance

Fig. 19. Inductive Turn-on Switching Times vs. Collector Current

Fig. 20. Inductive Turn-on Switching Times vs. Junction Temperature

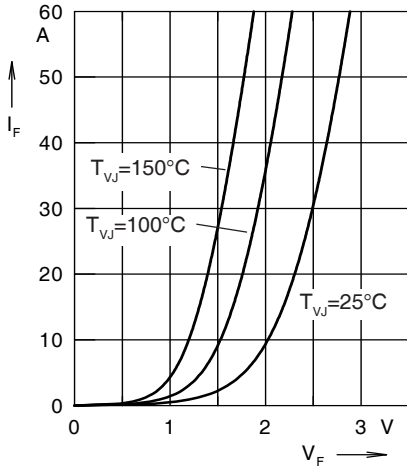

Fig. 21. Forward Current I_F Versus V_F

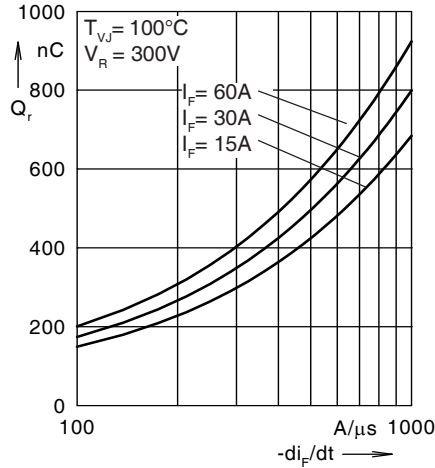

Fig. 22. Reverse Recovery Charge Q_r Versus $-di_F/dt$

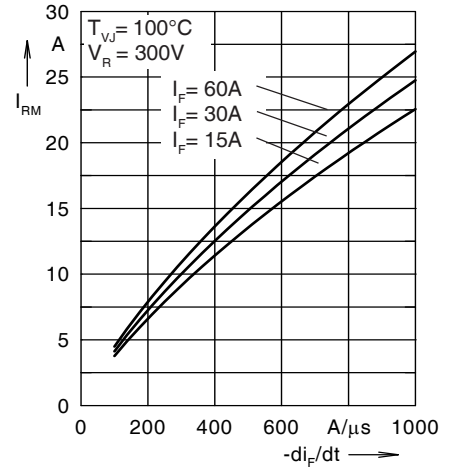

Fig. 23. Peak Reverse Current I_{RM} Versus $-di_F/dt$

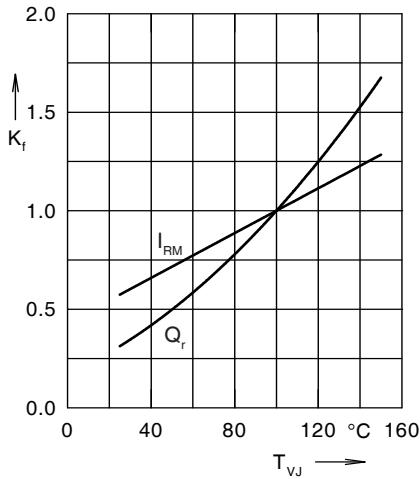

Fig. 24. Dynamic Parameters Q_r , I_{RM} Versus T_{VJ}

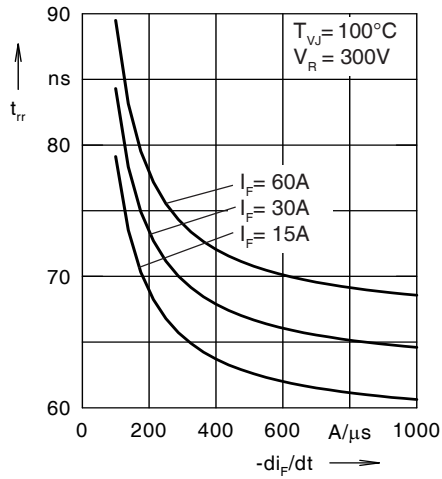

Fig. 25. Recovery Time t_{tr} Versus $-di_F/dt$

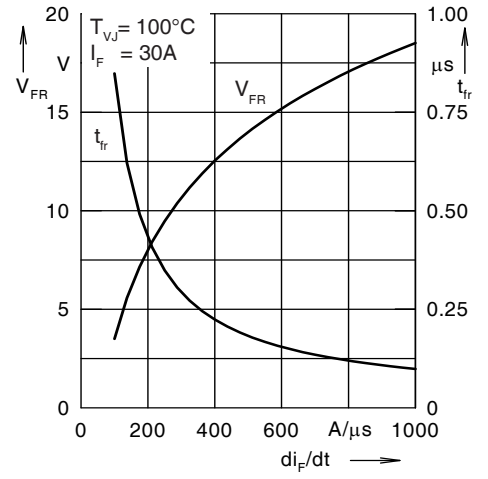

Fig. 26. Peak Forward Voltage V_{FR} and t_{tr} Versus di_F/dt

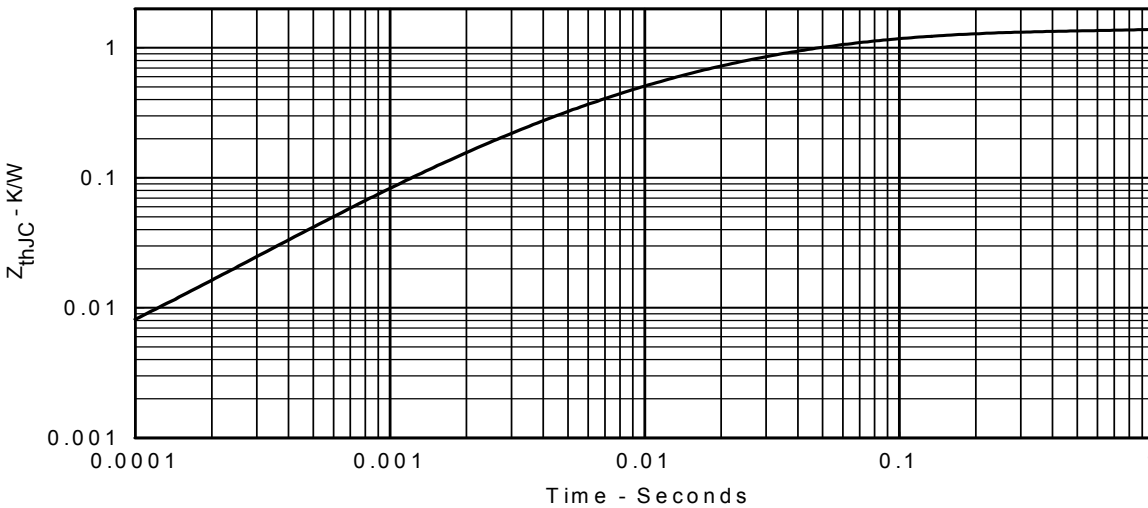

Fig. 27. Transient Thermal Resistance Impedance (for Diode)



Disclaimer Notice - Information furnished is believed to be accurate and reliable. However, users should independently evaluate the suitability of and test each product selected for their own applications. Littelfuse products are not designed for, and may not be used in, all applications. Read complete Disclaimer Notice at www.littelfuse.com/disclaimer-electronics.