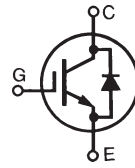
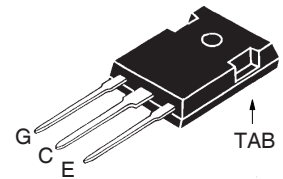

**GenX3™ C3-Class
IGBT w/Diode**
IXGH40N120C3D1

$$\begin{aligned}
 V_{CES} &= 1200V \\
 I_{C110} &= 40A \\
 V_{CE(sat)} &\leq 4.4V \\
 t_{fi(typ)} &= 57ns
 \end{aligned}$$

**High Speed PT IGBT
for 20 - 50 kHz Switching**

Symbol	Test Conditions	Maximum Ratings	
V_{CES}	$T_J = 25^\circ\text{C}$ to 150°C	1200	V
V_{CGR}	$T_J = 25^\circ\text{C}$ to 150°C , $R_{GE} = 1M\Omega$	1200	V
V_{GES}	Continuous	± 20	V
V_{GEM}	Transient	± 30	V
I_{C25}	$T_C = 25^\circ\text{C}$ (Limited by Leads)	75	A
I_{C110}	$T_C = 110^\circ\text{C}$	40	A
I_{F110}	$T_C = 110^\circ\text{C}$	25	A
I_{CM}	$T_C = 25^\circ\text{C}$, 1ms	180	A
I_A	$T_C = 25^\circ\text{C}$	30	A
E_{AS}	$T_C = 25^\circ\text{C}$	500	mJ
SSOA	$V_{GE} = 15V$, $T_J = 125^\circ\text{C}$, $R_G = 3\Omega$	$I_{CM} = 80$	A
(RBSOA)	Clamped inductive load	@ $V_{CE} \leq 1200$	V
P_C	$T_C = 25^\circ\text{C}$	380	W
T_J		-55 ... +150	$^\circ\text{C}$
T_{JM}		150	$^\circ\text{C}$
T_{stg}		-55 ... +150	$^\circ\text{C}$
M_d	Mounting Torque	1.13 / 10	Nm/lb.in.
T_L	Maximum Lead Temperature for Soldering	300	$^\circ\text{C}$
T_{SOLD}	1.6mm (0.062 in.) from Case for 10s	260	$^\circ\text{C}$
Weight		6	g

TO-247

G = Gate C = Collector
E = Emitter TAB = Collector

Features

- Optimized for Low Conduction Losses
- Square RBSOA
- Avalanche Rated
- Anti-Parallel Ultra Fast Diode
- International Standard Package

Advantages

- High Power Density
- Low Gate Drive Requirement

Applications

- Switch-Mode and Resonant-Mode Power Supplies
- Uninterruptible Power Supplies (UPS)
- DC Choppers
- AC Motor Drives
- DC Servo and Robot Drives

Symbol	Test Conditions	Characteristic Values		
		Min.	Typ.	Max.
$V_{GE(th)}$	$I_C = 250\mu\text{A}$, $V_{CE} = V_{GE}$	3.0		5.0 V
I_{CES}	$V_{CE} = V_{CES}$, $V_{GE} = 0V$ $T_J = 125^\circ\text{C}$			100 μA 3 mA
I_{GES}	$V_{CE} = 0V$, $V_{GE} = \pm 20V$			± 100 nA
$V_{CE(sat)}$	$I_C = 30A$, $V_{GE} = 15V$, Note 1 $T_J = 125^\circ\text{C}$		2.7	4.4 V V

Symbol	Test Conditions	Characteristic Values		
		Min.	Typ.	Max.
g_{fs}	$I_C = 30A, V_{CE} = 10V$, Note 1	18	30	S
C_{ies}	$V_{CE} = 25V, V_{GE} = 0V, f = 1MHz$		2930	pF
C_{oes}			240	pF
C_{res}			93	pF
Q_g	$I_C = 40A, V_{GE} = 15V, V_{CE} = 0.5 \cdot V_{CES}$		142	nC
Q_{ge}			19	nC
Q_{gc}			62	nC
$t_{d(on)}$	Inductive load, $T_J = 25^\circ C$ $I_C = 30A, V_{GE} = 15V$ $V_{CE} = 600V, R_G = 3\Omega$ Note 2		17	ns
t_{ri}			33	ns
E_{on}			1.80	mJ
$t_{d(off)}$			130	ns
t_{fi}			57	100 ns
E_{off}			0.55	1.00 mJ
$t_{d(on)}$	Inductive load, $T_J = 25^\circ C$ $I_C = 30A, V_{GE} = 15V$ $V_{CE} = 600V, R_G = 3\Omega$ Note 2		17	ns
t_{ri}			35	ns
E_{on}			3.50	mJ
$t_{d(off)}$			177	ns
t_{fi}			298	ns
E_{off}			1.60	mJ
R_{thJC}				0.33 °C/W
R_{thCK}		0.21		°C/W

TO-247 (IXGH) Outline

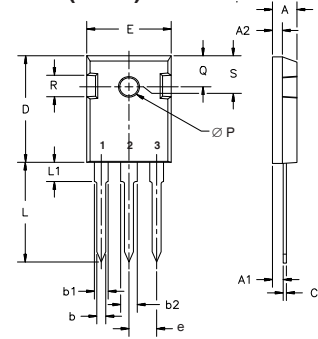

Terminals: 1 - Gate 2 - Drain
3 - Source Tab - Drain

Dim.	Millimeter		Inches	
	Min.	Max.	Min.	Max.
A	4.7	5.3	.185	.209
A ₁	2.2	2.54	.087	.102
A ₂	2.2	2.6	.059	.098
b	1.0	1.4	.040	.055
b ₁	1.65	2.13	.065	.084
b ₂	2.87	3.12	.113	.123
C	.4	.8	.016	.031
D	20.80	21.46	.819	.845
E	15.75	16.26	.610	.640
e	5.20	5.72	0.205	0.225
L	19.81	20.32	.780	.800
L1		4.50		.177
ØP	3.55	3.65	.140	.144
Q	5.89	6.40	0.232	0.252
R	4.32	5.49	.170	.216
S	6.15	BSC	242	BSC

Reverse Diode (FRED)

($T_J = 25^\circ C$, Unless Otherwise Specified)

Symbol	Test Conditions	Characteristic Value		
		Min.	Typ.	Max.
V_F	$I_F = 30A, V_{GE} = 0V$, Note 1		1.6	2.8 V
I_{RM}	$I_F = 30A, V_{GE} = 0V, -di_F/dt = 100A/\mu s, T_J = 100^\circ C$			4 A
t_{rr}		$V_R = 300V, T_J = 100^\circ C$		100
R_{thJC}				0.9 °C/W

Note 1: Pulse Test, $t \leq 300\mu s$, Duty Cycle, $d \leq 2\%$.

2. Switching Times may Increase for V_{CE} (Clamp) $> 0.5 V_{CES}$, Higher T_J or Increased R_G .

PRELIMINARY TECHNICAL INFORMATION

The product presented herein is under development. The Technical Specifications offered are derived from data gathered during objective characterizations of preliminary engineering lots; but also may yet contain some information supplied during a pre-production design evaluation. IXYS reserves the right to change limits, test conditions, and dimensions without notice.

IXYS Reserves the Right to Change Limits, Test Conditions, and Dimensions.

IXYS MOSFETs and IGBTs are covered by one or more of the following U.S. patents:	4,835,592	4,931,844	5,049,961	5,237,481	6,162,665	6,404,065 B1	6,683,344	6,727,585	7,005,734 B2	7,157,338B2
	4,850,072	5,017,508	5,063,307	5,381,025	6,259,123 B1	6,534,343	6,710,405 B2	6,759,692	7,063,975 B2	
	4,881,106	5,034,796	5,187,117	5,486,715	6,306,728 B1	6,583,505	6,710,463	6,771,478 B2	7,071,537	

**Fig. 1. Output Characteristics
@ 25°C**

**Fig. 2. Extended Output Characteristics
@ 25°C**

**Fig. 3. Output Characteristics
@ 125°C**

**Fig. 4. Dependence of $V_{CE(sat)}$ on
Junction Temperature**

**Fig. 5. Collector-to-Emitter Voltage
vs. Gate-to-Emitter Voltage**

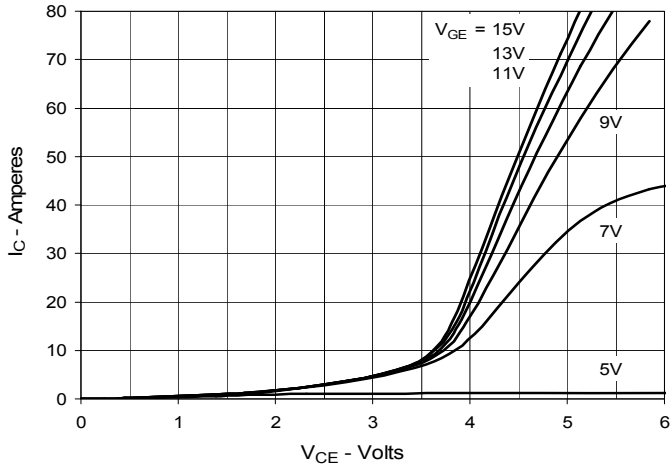
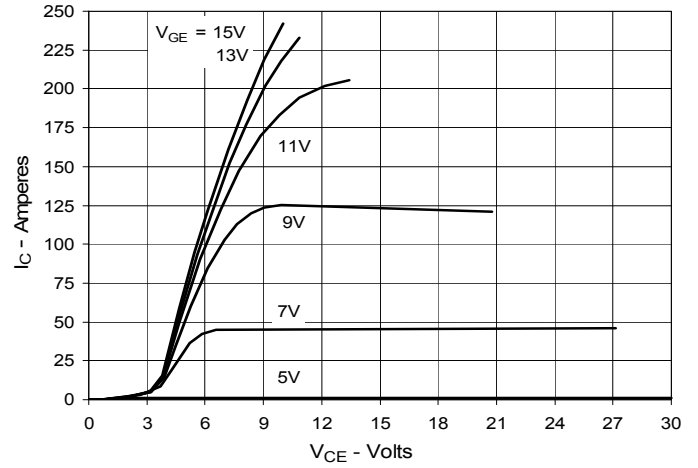
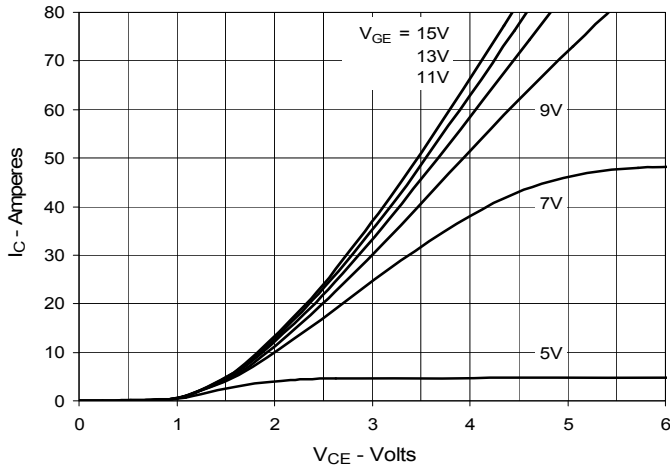
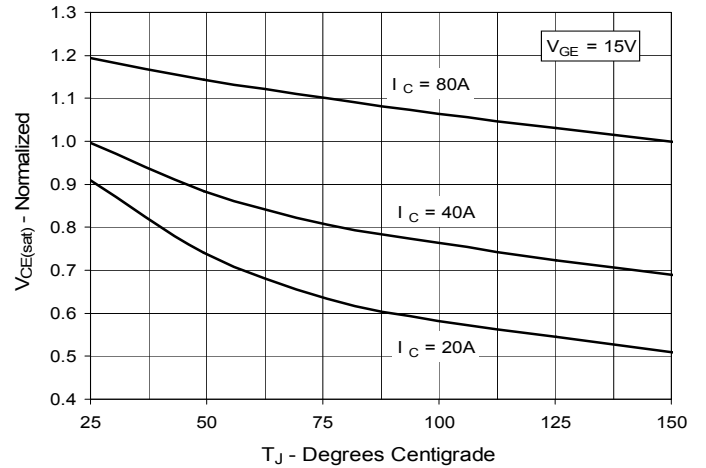
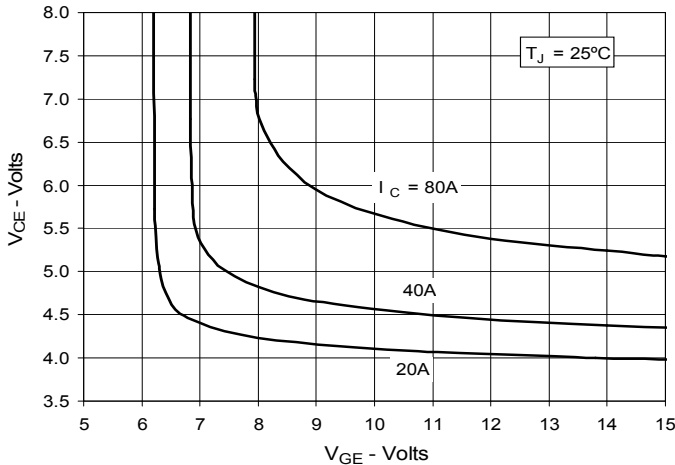
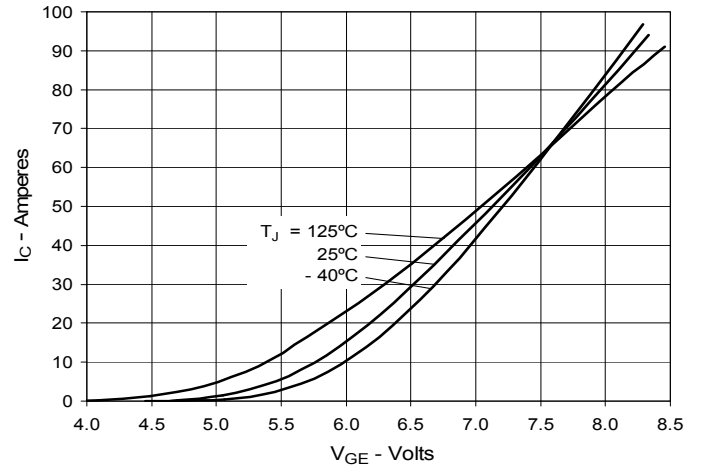
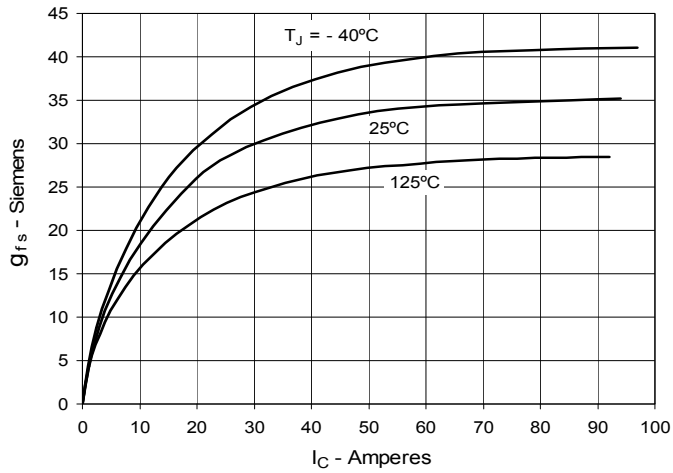
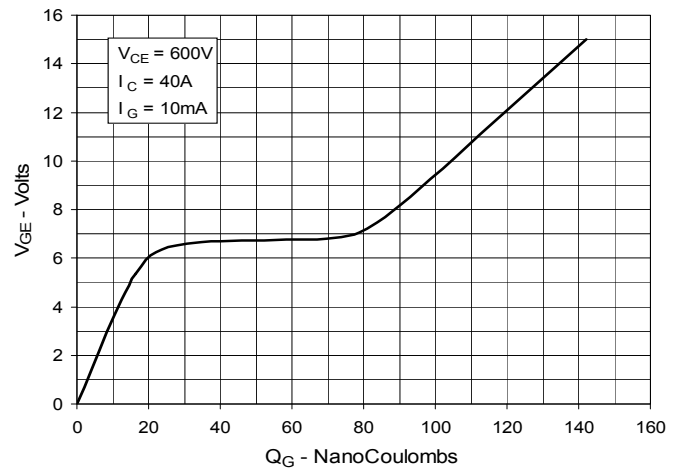
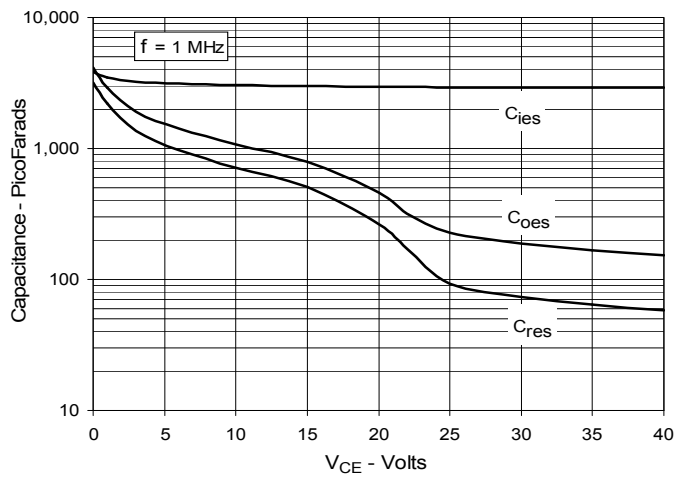
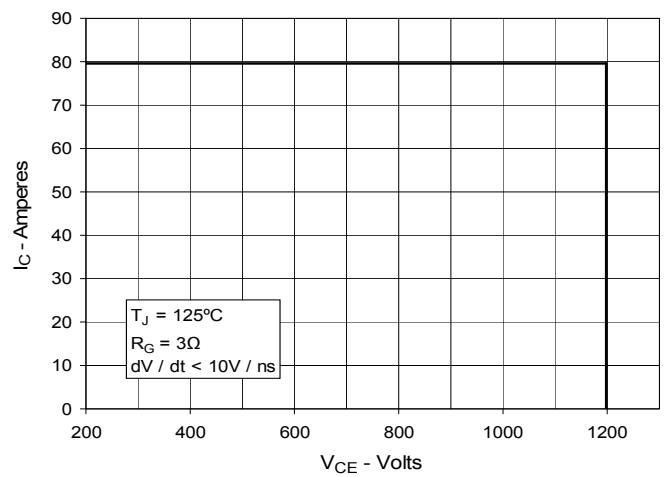
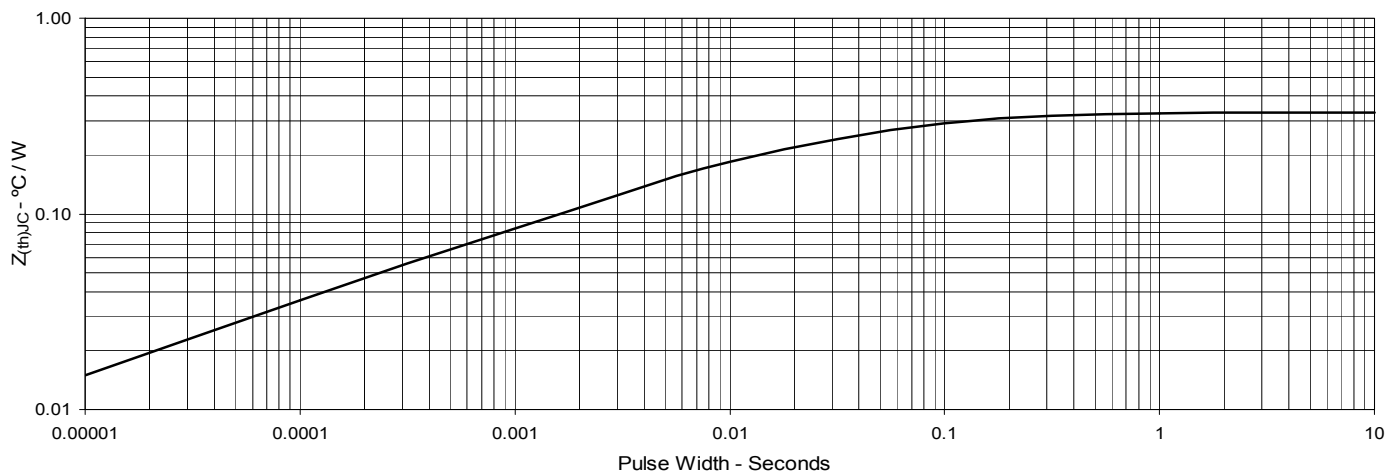
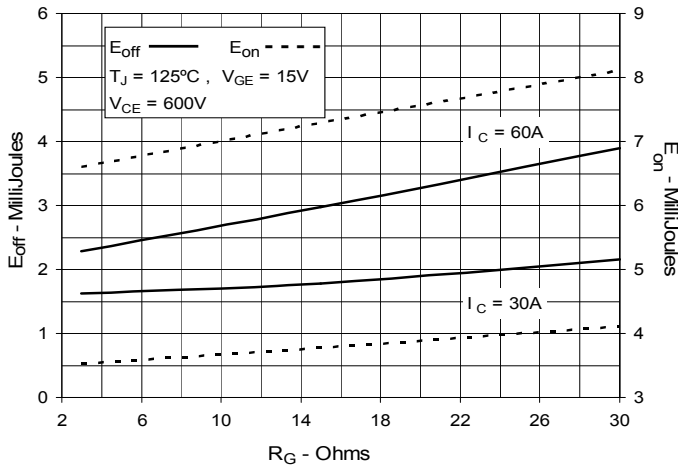
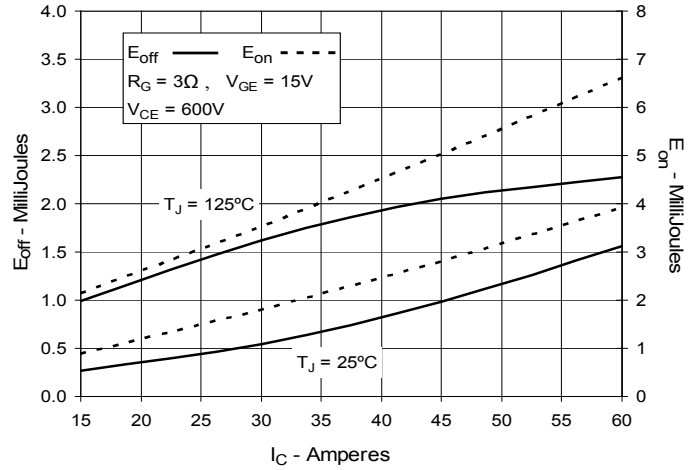
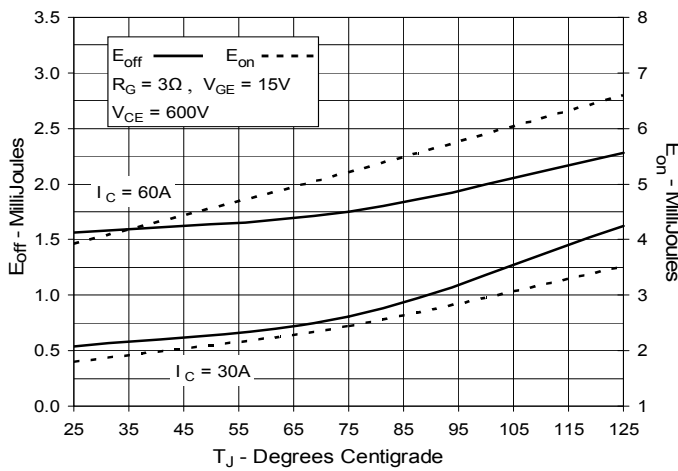
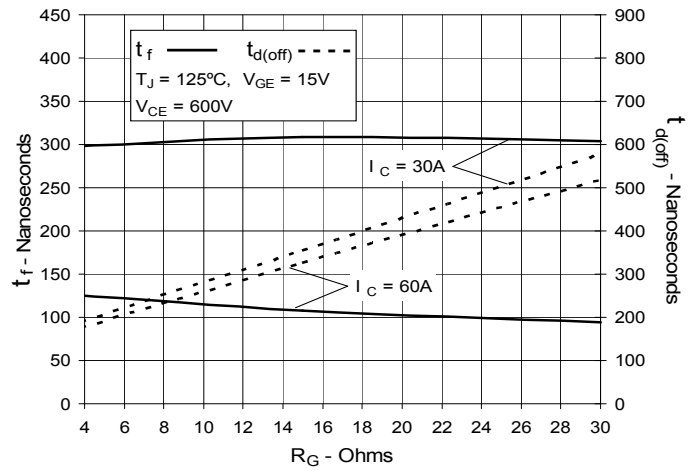
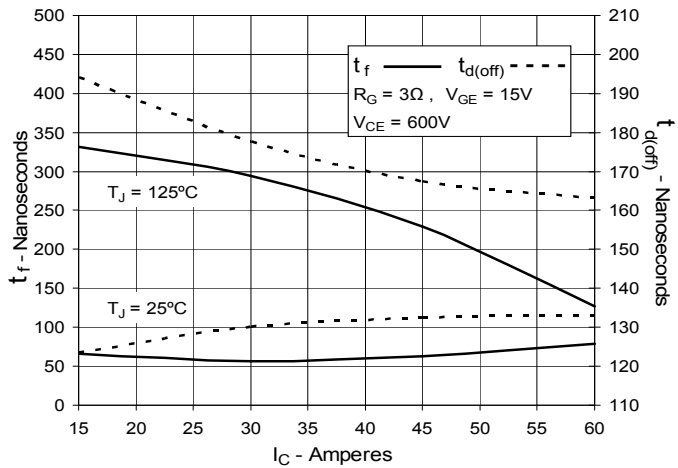
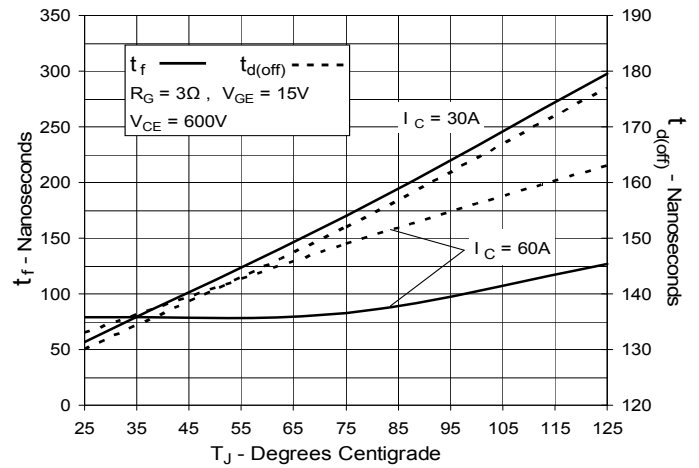
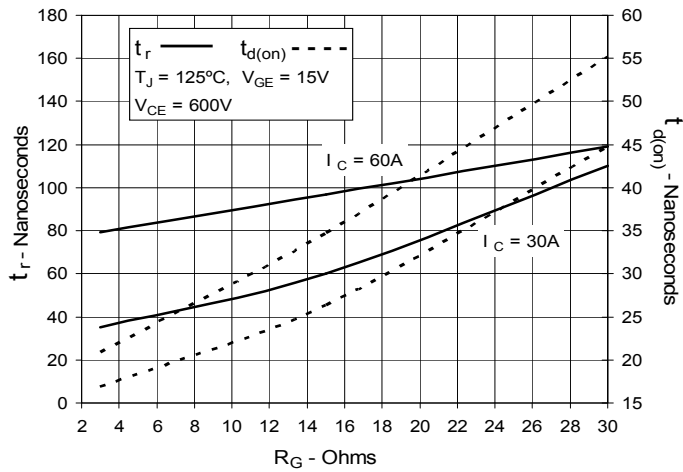
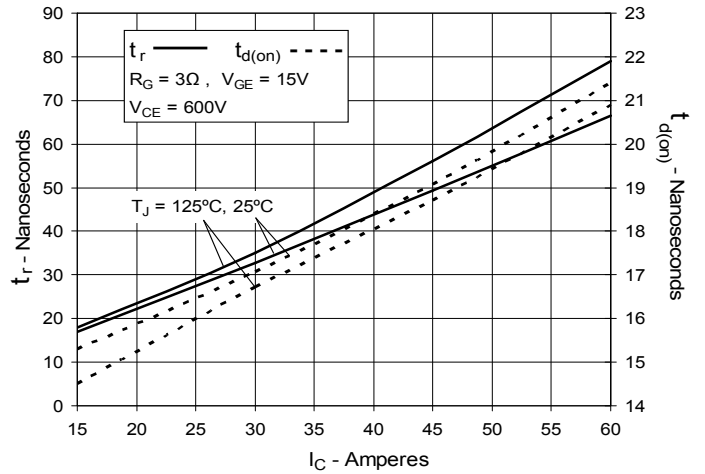
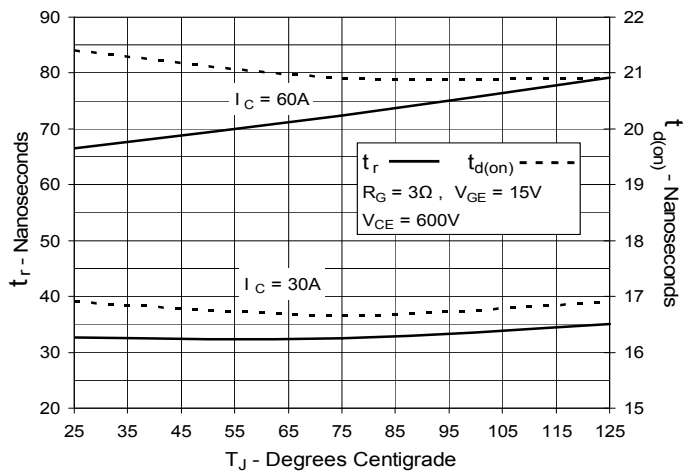
Fig. 6. Input Admittance

Fig. 7. Transconductance

Fig. 8. Gate Charge

Fig. 9. Capacitance

Fig. 10. Reverse-Bias Safe Operating Area

Fig. 11. Maximum Transient Thermal Impedance

IXYS Reserves the Right to Change Limits, Test Conditions, and Dimensions.

Fig. 12. Inductive Switching Energy Loss vs. Gate Resistance

Fig. 13. Inductive Switching Energy Loss vs. Collector Current

Fig. 14. Inductive Switching Energy Loss vs. Junction Temperature

Fig. 15. Inductive Turn-off Switching Times vs. Gate Resistance

Fig. 16. Inductive Turn-off Switching Times vs. Collector Current

Fig. 17. Inductive Turn-off Switching Times vs. Junction Temperature

**Fig. 18. Inductive Turn-on
Switching Times vs. Gate Resistance**

**Fig. 19. Inductive Turn-on
Switching Times vs. Collector Current**

**Fig. 20. Inductive Turn-on
Switching Times vs. Junction Temperature**

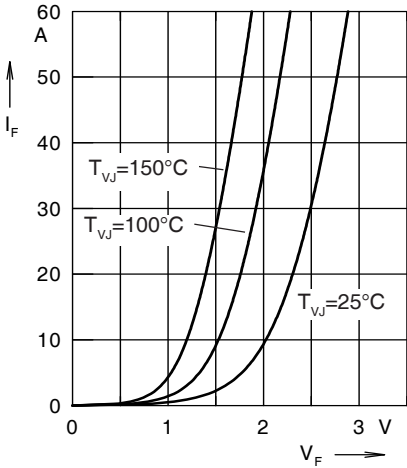

Fig. 21. Forward Current I_F Versus V_F

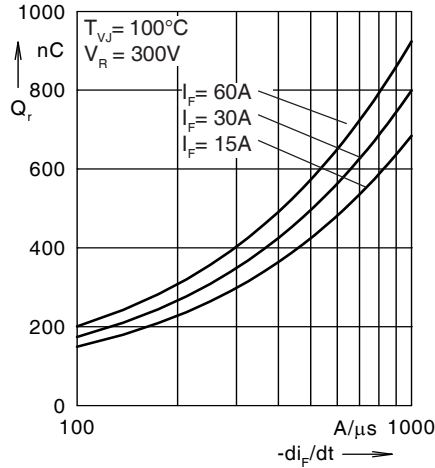

Fig. 22. Reverse Recovery Charge Q_r Versus $-di_F/dt$

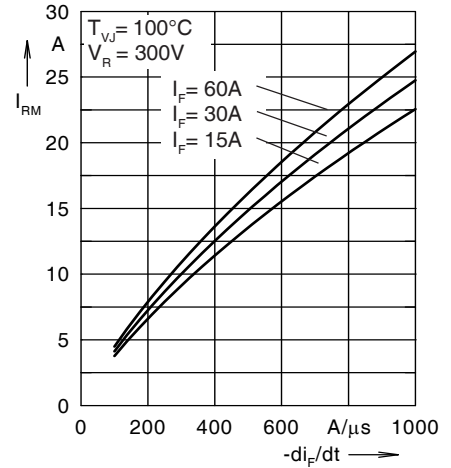

Fig. 23. Peak Reverse Current I_{RM} Versus $-di_F/dt$

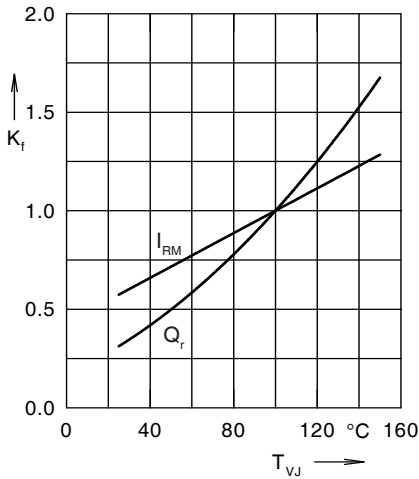

Fig. 24. Dynamic Parameters Q_r , I_{RM} Versus T_{VJ}

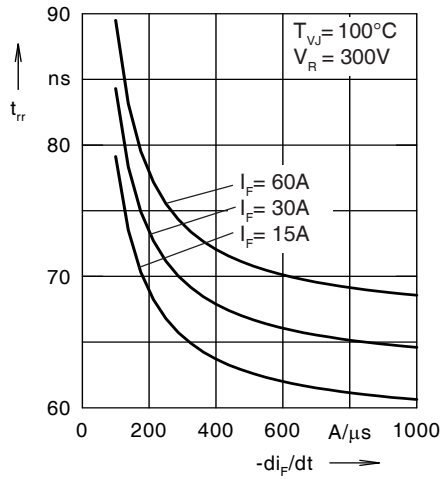

Fig. 25. Recovery Time t_{tr} Versus $-di_F/dt$

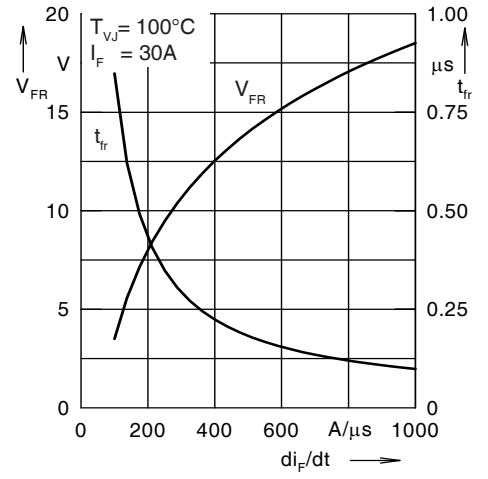

Fig. 26. Peak Forward Voltage V_{FR} and t_{tr} Versus di_F/dt

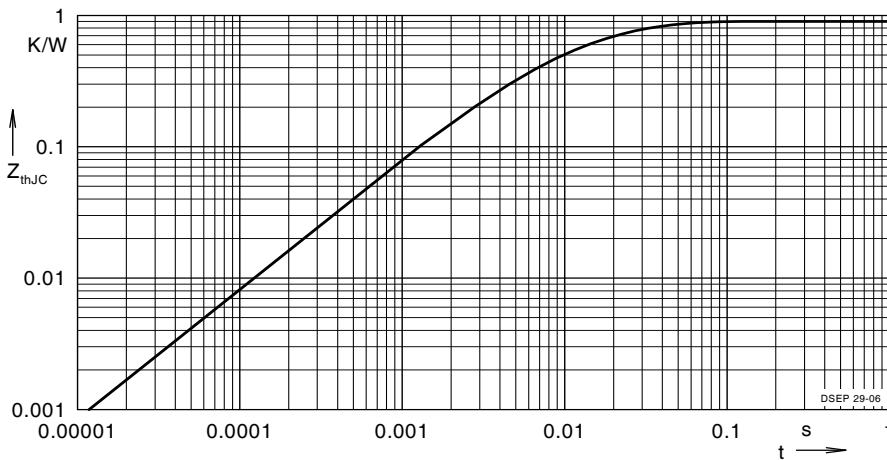

Fig. 27. Transient Thermal Resistance Junction to Case



Disclaimer Notice - Information furnished is believed to be accurate and reliable. However, users should independently evaluate the suitability of and test each product selected for their own applications. Littelfuse products are not designed for, and may not be used in, all applications. Read complete Disclaimer Notice at www.littelfuse.com/disclaimer-electronics.