

# GenX3™ 1200V IGBT

# IXGH30N120B3D1 IXGT30N120B3D1

High speed Low V<sub>sat</sub> PT  
IGBTs 3-20 kHz switching



**V<sub>CES</sub>** = 1200V  
**I<sub>C110</sub>** = 30A  
**V<sub>CE(sat)</sub>** ≤ 3.5V  
**t<sub>fi(typ)</sub>** = 204ns

Symbol	Test Conditions	Maximum Ratings	
<b>V<sub>CES</sub></b>	T <sub>J</sub> = 25°C to 150°C	1200	V
<b>V<sub>CGR</sub></b>	T <sub>J</sub> = 25°C to 150°C, R <sub>GE</sub> = 1MΩ	1200	V
<b>V<sub>GES</sub></b>	Continuous	±20	V
<b>V<sub>GEM</sub></b>	Transient	±30	V
<b>I<sub>C110</sub></b>	T <sub>C</sub> = 110°C	30	A
<b>I<sub>F110</sub></b>	T <sub>C</sub> = 110°C	28	A
<b>I<sub>CM</sub></b>	T <sub>C</sub> = 25°C, 1ms	150	A
<b>SSOA</b> <b>(RBSOA)</b>	V <sub>GE</sub> = 15V, T <sub>VJ</sub> = 125°C, R <sub>G</sub> = 5Ω Clamped inductive load	I <sub>CM</sub> = 60 @ 0.8 • V <sub>CE</sub>	A
<b>P<sub>c</sub></b>	T <sub>C</sub> = 25°C	300	W
<b>T<sub>J</sub></b>		-55 ... +150	°C
<b>T<sub>JM</sub></b>		150	°C
<b>T<sub>stg</sub></b>		-55 ... +150	°C
<b>M<sub>d</sub></b>	Mounting torque (TO-247)	1.13 / 10	Nm/lb.in.
<b>T<sub>L</sub></b>	Maximum lead temperature for soldering	300	°C
<b>T<sub>SOLD</sub></b>	1.6mm (0.062 in.) from case for 10s	260	°C
<b>Weight</b>	TO-247	6	g
	TO-268	4	g

## TO-247 AD (IXGH)

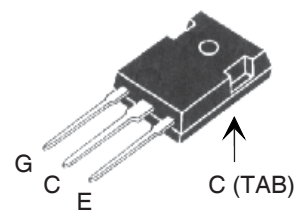

## TO-268 (IXGT)

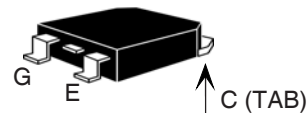

G = Gate      C = Collector  
E = Emitter    TAB = Collector

## Features

- Optimized for low conduction and switching losses
- Square RBSOA
- Anti-parallel ultra fast diode
- International standard packages

## Advantages

- High power density
- Low gate drive requirement

## Applications

- Power Inverters
- UPS
- Motor Drives
- SMPS
- PFC Circuits
- Welding Machines

Symbol	Test Conditions	Characteristic Values (T <sub>J</sub> = 25°C, unless otherwise specified)		
		Min.	Typ.	Max.
<b>V<sub>GE(th)</sub></b>	I <sub>C</sub> = 250μA, V <sub>CE</sub> = V <sub>GE</sub>	3.0		5.0 V
<b>I<sub>CES</sub></b>	V <sub>CE</sub> = V <sub>CES</sub> V <sub>GE</sub> = 0V T <sub>J</sub> = 125°C			300 μA 1.5 mA
<b>I<sub>GES</sub></b>	V <sub>CE</sub> = 0V, V <sub>GE</sub> = ±20V			±100 nA
<b>V<sub>CE(sat)</sub></b>	I <sub>C</sub> = 30A, V <sub>GE</sub> = 15V, Note 1 T <sub>J</sub> = 125°C	2.96 2.95	3.5	V V

Symbol	Test Conditions	Characteristic Values			
		Min.	Typ.	Max.	
$g_{fs}$	$I_C = 30A, V_{CE} = 10V, \text{Note 1}$	11	19	S	
$C_{ies}$ $C_{oes}$ $C_{res}$	$V_{CE} = 25V, V_{GE} = 0V, f = 1MHz$		1750	pF	
			120	pF	
			46	pF	
$Q_g$ $Q_{ge}$ $Q_{gc}$	$I_C = 30A, V_{GE} = 15V, V_{CE} = 0.5 \cdot V_{CES}$		87	nC	
			15	nC	
			39	nC	
$t_{d(on)}$ $t_{ri}$ $E_{on}$ $t_{d(off)}$ $t_{fi}$ $E_{off}$	<b>Inductive load, <math>T_J = 25^\circ C</math></b> $I_C = 30A, V_{GE} = 15V, \text{Notes 2}$ $V_{CE} = 0.8 \cdot V_{CES}, R_G = 5\Omega$		16	ns	
			37	ns	
			3.47	mJ	
			127	200	ns
			204	380	ns
			2.16	4.0	mJ
$t_{d(on)}$ $t_{ri}$ $E_{on}$ $t_{d(off)}$ $t_{fi}$ $E_{off}$	<b>Inductive load, <math>T_J = 125^\circ C</math></b> $I_C = 30A, V_{GE} = 15V, \text{Notes 2}$ $V_{CE} = 0.8 \cdot V_{CES}, R_G = 5\Omega$		18	ns	
			38	ns	
			6.70	mJ	
			216	ns	
			255	ns	
			5.10	mJ	
$R_{thJC}$ $R_{thCS}$		0.21	0.42 $^\circ C/W$ $^\circ C/W$		

### Reverse Diode (FRED)

Symbol	Test Conditions	Characteristic Values		
		Min.	Typ.	Max.
$V_F$	$I_F = 30A, V_{GE} = 0V, \text{Note 1}$			2.8 V
	$T_J = 150^\circ C$		1.6	V
$I_{RM}$ $t_{rr}$	$I_F = 30A, V_{GE} = 0V, -di_F/dt = 100A/\mu s, T_J = 100^\circ C$ $V_R = 300V, T_J = 100^\circ C$			4 A
			100	
$R_{thJC}$				0.9 $^\circ C/W$

Note 1: Pulse test,  $t \leq 300\mu s$ , duty cycle,  $d \leq 2\%$ .

2. Switching times may increase for  $V_{CE}$  (Clamp)  $> 0.8 V_{CES}$ , higher  $T_J$  or increased  $R_G$ .

### TO-247 AD Outline

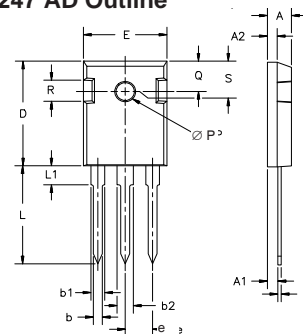

Dim.	Millimeter		Inches	
	Min.	Max.	Min.	Max.
A	4.7	5.3	.185	.209
A <sub>1</sub>	2.2	2.54	.087	.102
A <sub>2</sub>	2.2	2.6	.059	.098
b	1.0	1.4	.040	.055
b <sub>1</sub>	1.65	2.13	.065	.084
b <sub>2</sub>	2.87	3.12	.113	.123
C	.4	.8	.016	.031
D	20.80	21.46	.819	.845
E	15.75	16.26	.610	.640
e	5.20	5.72	0.205	0.225
L	19.81	20.32	.780	.800
L <sub>1</sub>		4.50		.177
∅P	3.55	3.65	.140	.144
Q	5.89	6.40	0.232	0.252
R	4.32	5.49	.170	.216

### TO-268 Outline

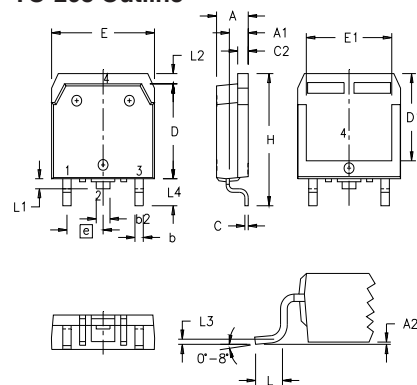

SYM	INCHES		MILLIMETERS	
	MIN	MAX	MIN	MAX
A	.193	.201	4.90	5.10
A1	.106	.114	2.70	2.90
A2	.001	.010	0.02	0.25
b	.045	.057	1.15	1.45
b2	.075	.083	1.90	2.10
C	.016	.026	0.40	0.65
C2	.057	.063	1.45	1.60
D	.543	.551	13.80	14.00
D1	.488	.500	12.40	12.70
E	.624	.632	15.85	16.05
E1	.524	.535	13.30	13.60
e	.215 BSC		5.45 BSC	
H	.736	.752	18.70	19.10
L	.094	.106	2.40	2.70
L1	.047	.055	1.20	1.40
L2	.039	.045	1.00	1.15
L3	.010 BSC		0.25 BSC	
L4	.150	.161	3.80	4.10

IXYS reserves the right to change limits, test conditions, and dimensions.

IXYS MOSFETs and IGBTs are covered by one or more of the following U.S. patents:	4,835,592	4,931,844	5,049,961	5,237,481	6,162,665	6,404,065 B1	6,683,344	6,727,585	7,005,734 B2	7,157,338B2
	4,850,072	5,017,508	5,063,307	5,381,025	6,259,123 B1	6,534,343	6,710,405 B2	6,759,692	7,063,975 B2	
	4,881,106	5,034,796	5,187,117	5,486,715	6,306,728 B1	6,583,505	6,710,463	6,771,478 B2	7,071,537	

**Fig. 1. Output Characteristics @ 25°C**

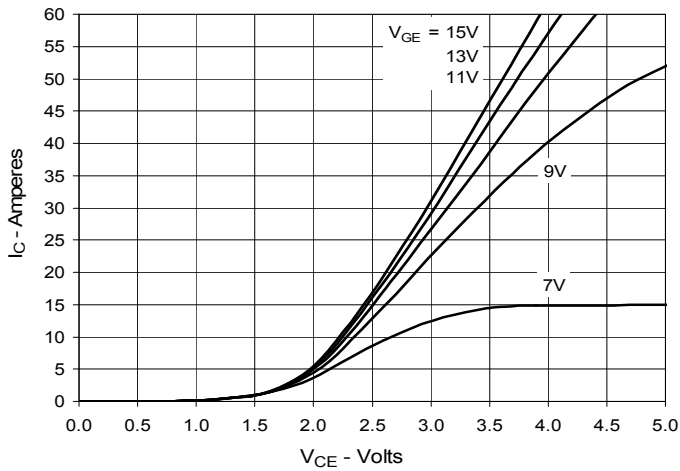

**Fig. 2. Extended Output Characteristics @ 25°C**

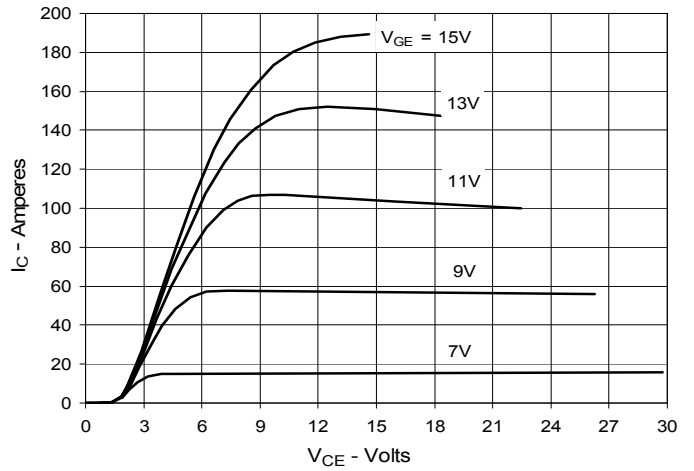

**Fig. 3. Output Characteristics @ 125°C**

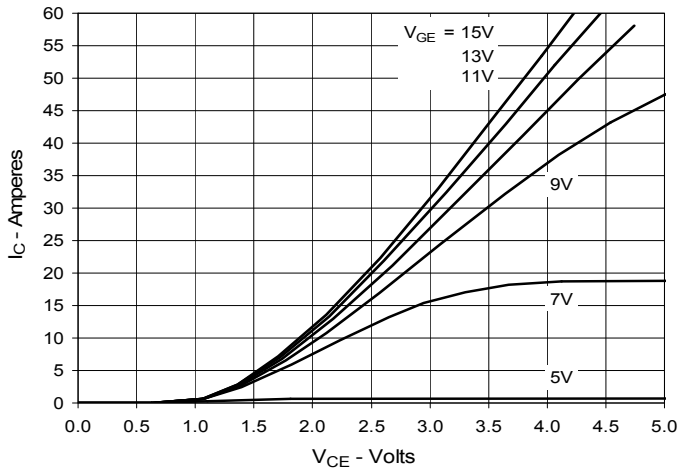

**Fig. 4. Dependence of VCE(sat) on Junction Temperature**

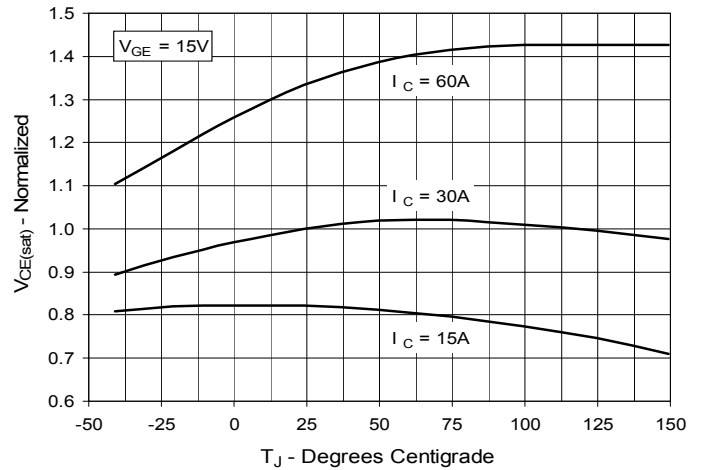

**Fig. 5. Collector-to-Emitter Voltage vs. Gate-to-Emitter Voltage**

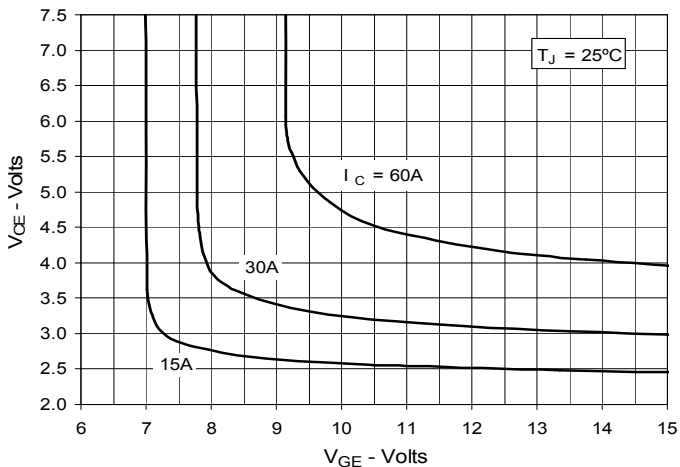

**Fig. 6. Input Admittance**

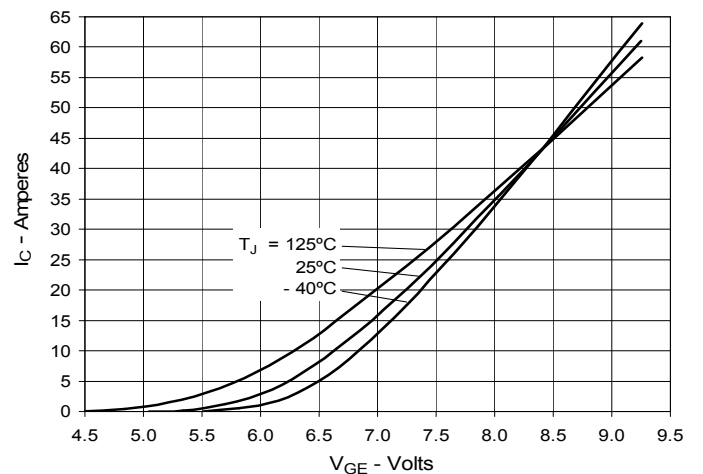

**Fig. 7. Transconductance**

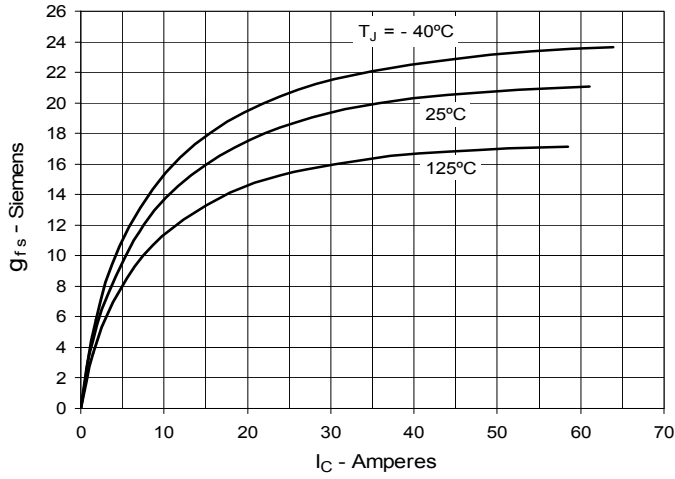

**Fig. 8. Gate Charge**

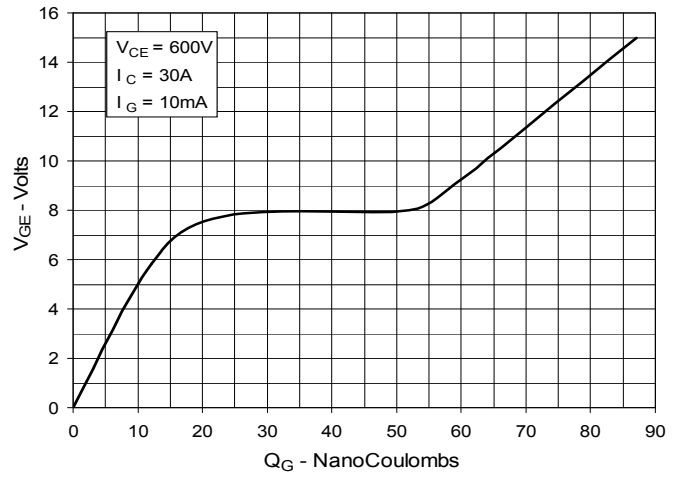

**Fig. 9. Capacitance**

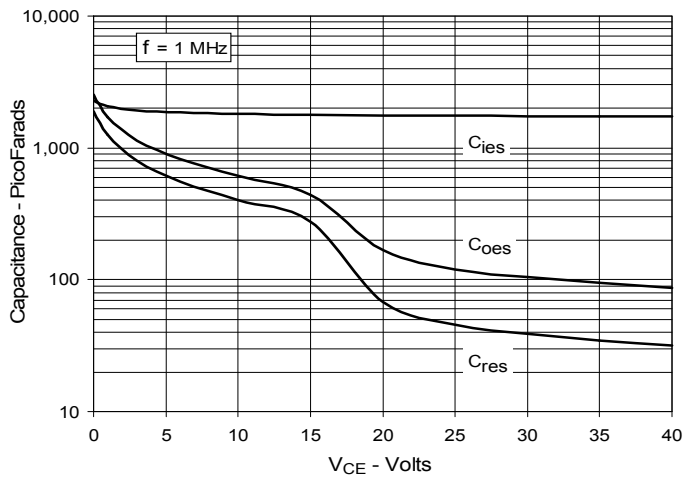

**Fig. 10. Reverse-Bias Safe Operating Area**

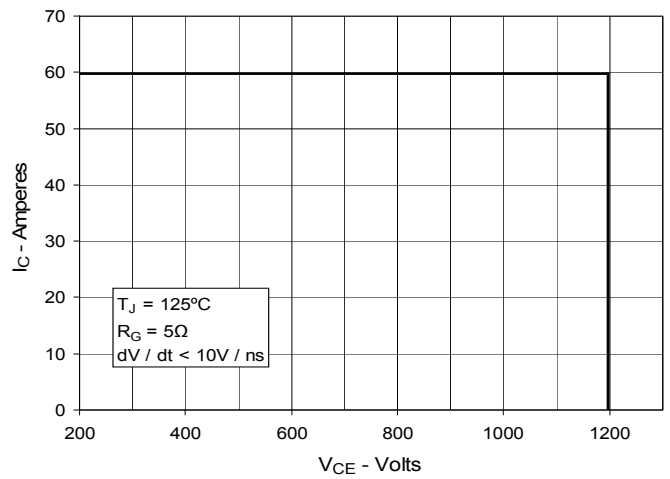

**Fig. 11. Maximum Transient Thermal Impedance**

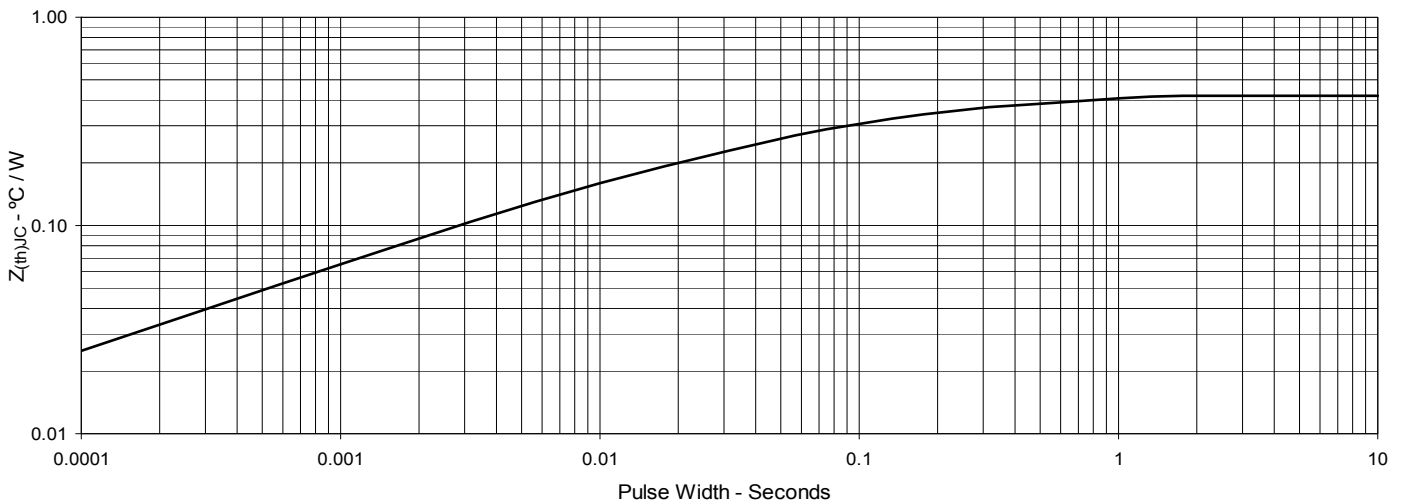

**Fig. 12. Inductive Switching Energy Loss vs. Gate Resistance**

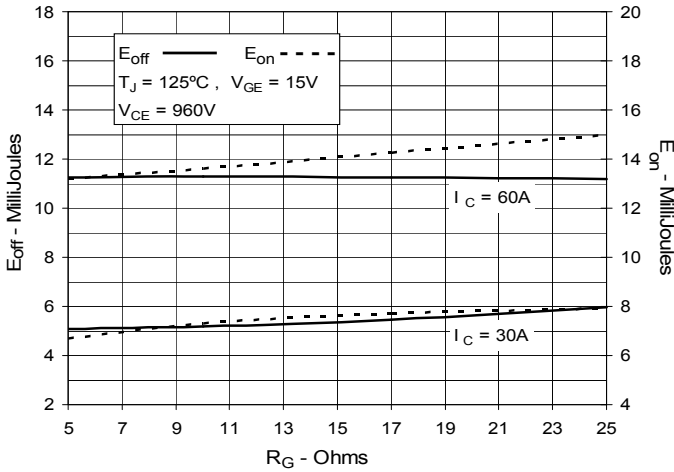

**Fig. 13. Inductive Switching Energy Loss vs. Collector Current**

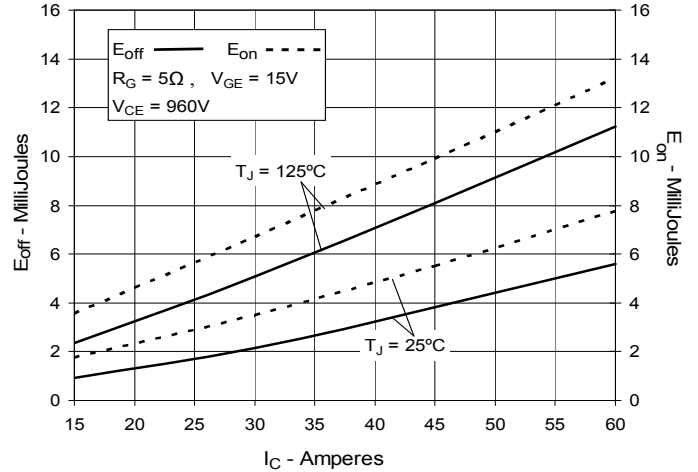

**Fig. 14. Inductive Switching Energy Loss vs. Junction Temperature**

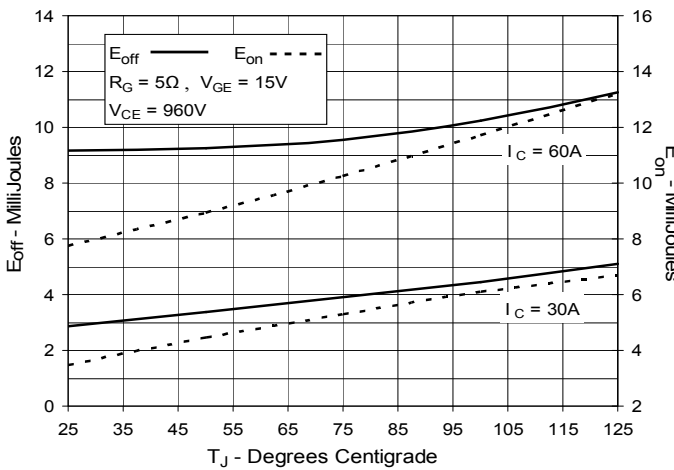

**Fig. 15. Inductive Turn-off Switching Times vs. Gate Resistance**

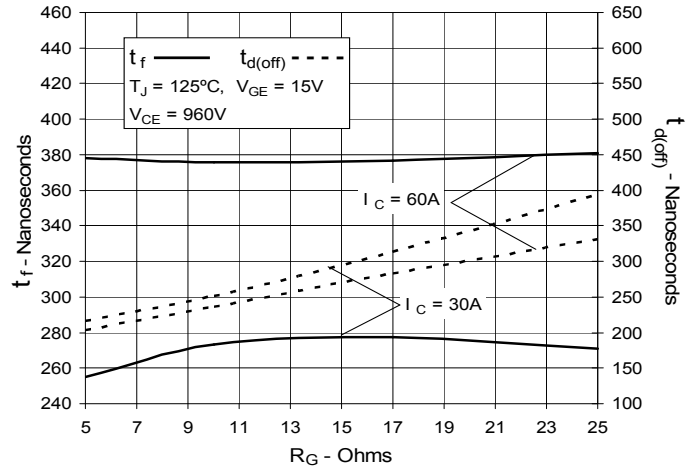

**Fig. 16. Inductive Turn-off Switching Times vs. Collector Current**

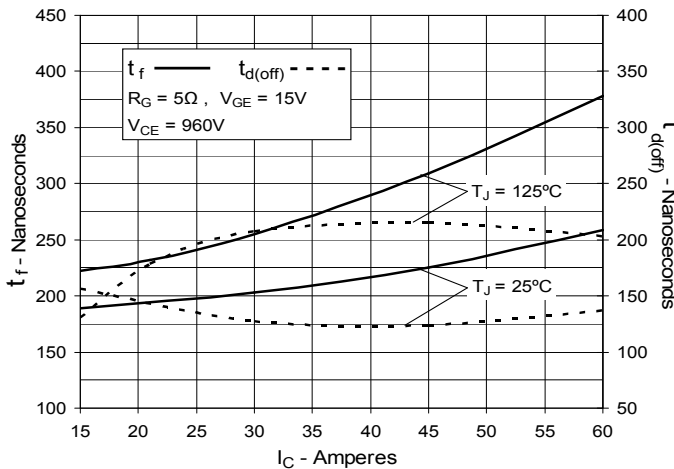

**Fig. 17. Inductive Turn-off Switching Times vs. Junction Temperature**

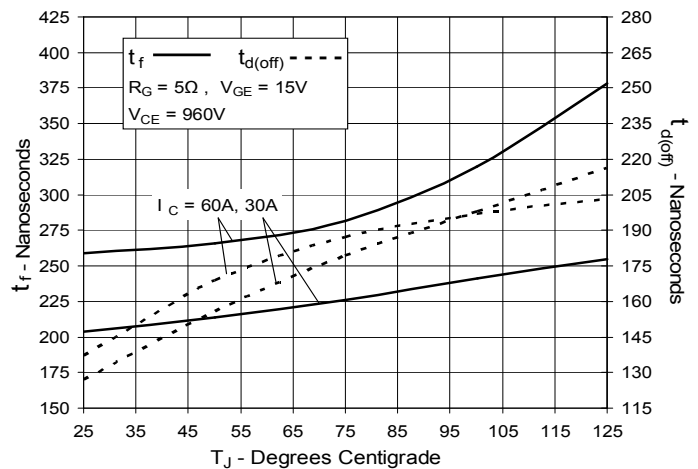

**Fig. 18. Inductive Turn-on  
Switching Times vs. Gate Resistance**

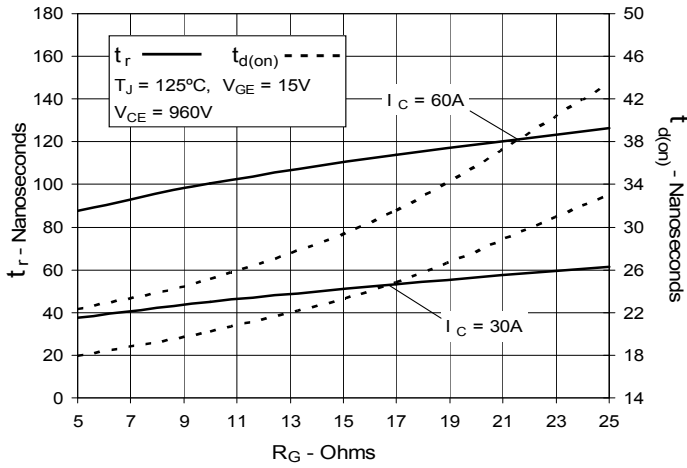

**Fig. 19. Inductive Turn-on  
Switching Times vs. Collector Current**

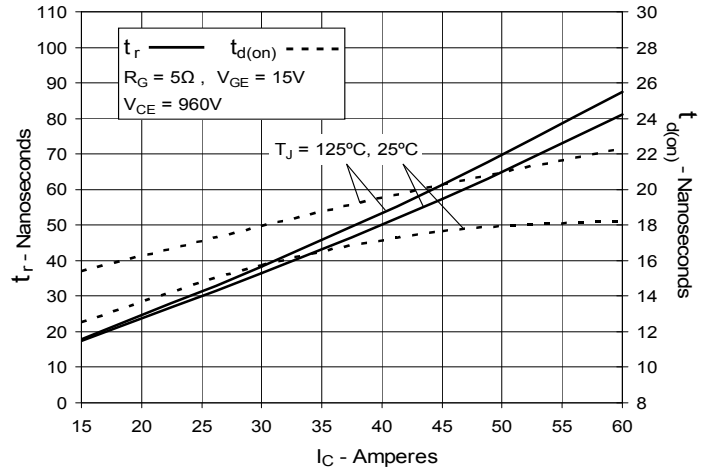

**Fig. 20. Inductive Turn-on  
Switching Times vs. Junction Temperature**

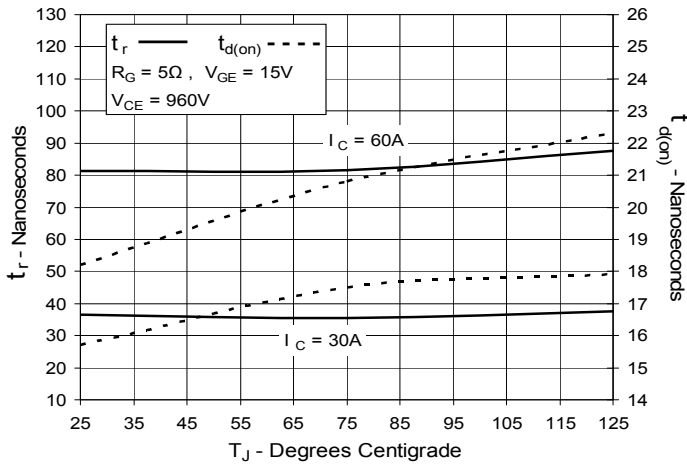

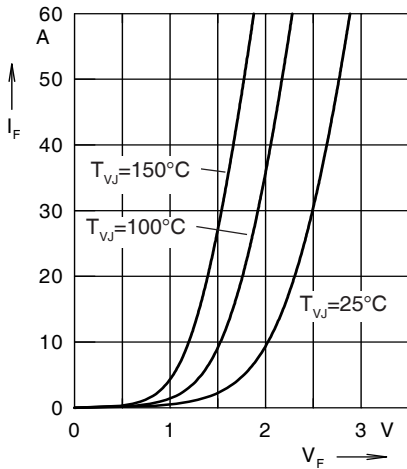

Fig. 21. Forward current  $I_F$  versus  $V_F$

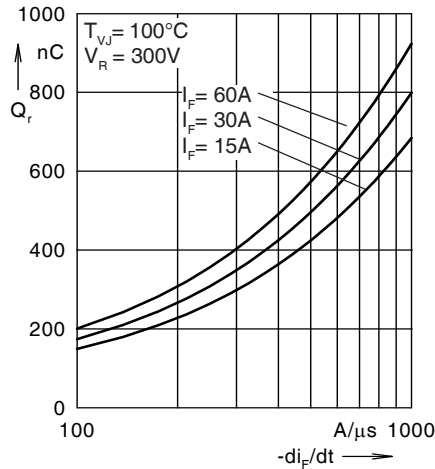

Fig. 22. Reverse recovery charge  $Q_r$  versus  $-di_F/dt$

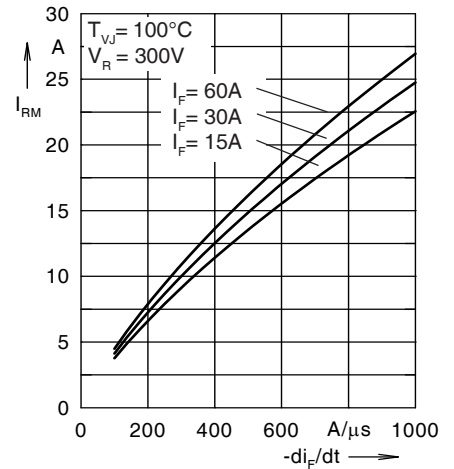

Fig. 23. Peak reverse current  $I_{RM}$  versus  $-di_F/dt$

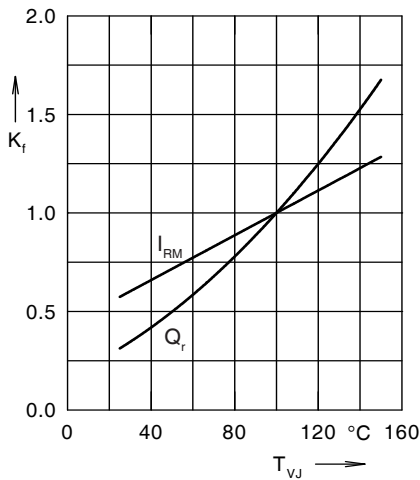

Fig. 24. Dynamic parameters  $Q_r$ ,  $I_{RM}$  versus  $T_{VJ}$

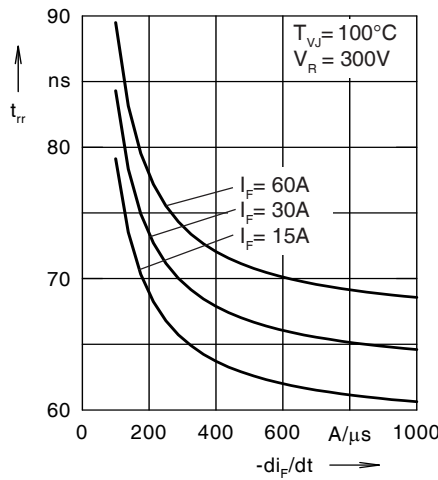

Fig. 25. Recovery time  $t_{rr}$  versus  $-di_F/dt$

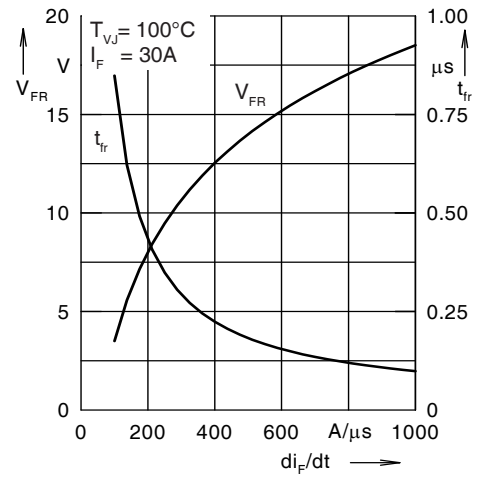

Fig. 26. Peak forward voltage  $V_{FR}$  and  $t_{fr}$  versus  $di_F/dt$

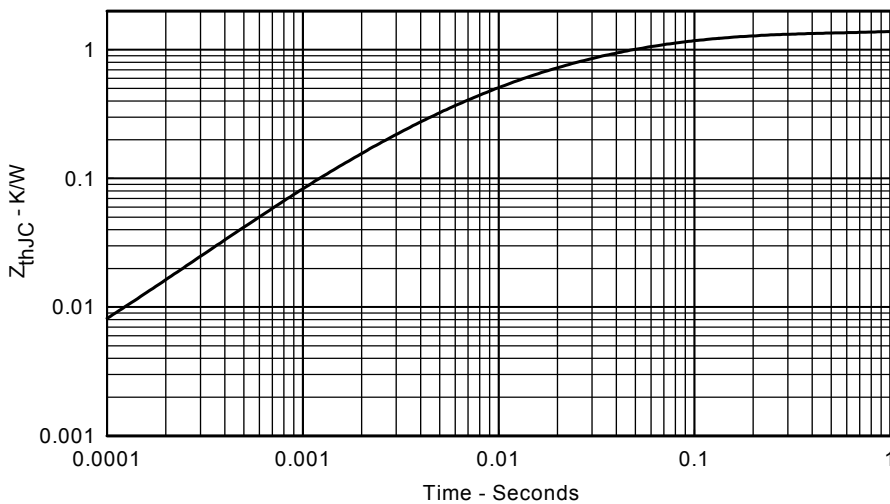

Fig. 27. Transient thermal resistance junction to case



---

Disclaimer Notice - Information furnished is believed to be accurate and reliable. However, users should independently evaluate the suitability of and test each product selected for their own applications. Littelfuse products are not designed for, and may not be used in, all applications. Read complete Disclaimer Notice at [www.littelfuse.com/disclaimer-electronics](http://www.littelfuse.com/disclaimer-electronics).