

HEXFET® Power MOSFET

Application

- Brushed motor drive applications
- BLDC motor drive applications
- Battery powered circuits
- Half-bridge and full-bridge topologies
- Synchronous rectifier applications
- Resonant mode power supplies
- OR-ing and redundant power switches
- DC/DC and AC/DC converters
- DC/AC inverters

Benefits

- Fully Characterized Capacitance and Avalanche SOA
- Enhanced body diode dV/dt and dI/dt Capability
- Lead-Free, RoHS Compliant

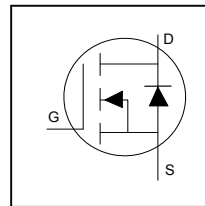

V_{DSS}	30V
R_{DS(on)} typ.	1.60mΩ
	1.95mΩ
I_D (Silicon Limited)	247A^①
I_D (Package Limited)	160A

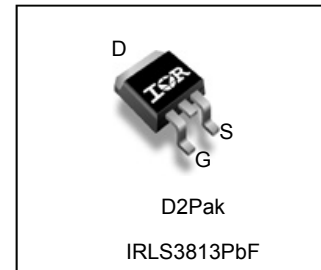

G	D	S
Gate	Drain	Source

Base part number	Package Type	Standard Pack		Orderable Part Number
		Form	Quantity	
IRLS3813PbF	D ² -Pak	Tube	50	IRLS3813PbF
		Tape and Reel Left	800	IRLS3813TRLPbF

Absolute Maximum Rating

Symbol	Parameter	Max.	Units
V _{DS}	Drain-to-Source Voltage	30	V
I _D @ T _C = 25°C	Continuous Drain Current, V _{GS} @ 10V (Silicon Limited)	247 ^①	A
I _D @ T _C = 100°C	Continuous Drain Current, V _{GS} @ 10V (Silicon Limited)	156	
I _D @ T _C = 25°C	Continuous Drain Current, V _{GS} @ 10V (Package Limited)	160	
I _{DM}	Pulsed Drain Current ^②	850 ^②	
P _D @ T _C = 25°C	Maximum Power Dissipation	195	W
	Linear Derating Factor	1.6	W/°C
V _{GS}	Gate-to-Source Voltage	± 20	V
T _J	Operating Junction and	-55 to + 150	°C
T _{STG}	Storage Temperature Range		
	Soldering Temperature, for 10 seconds (1.6mm from case)	300	

Avalanche Characteristics

Symbol	Parameter	Max.	Units
E _{AS} (Thermally limited)	Single Pulse Avalanche Energy ^③	177	mJ
I _{AR}	Avalanche Current	148	A

Thermal Resistance

Symbol	Parameter	Typ.	Max.	Units
R _{θJC}	Junction-to-Case ^④	—	0.64	°C/W
R _{θJA}	Junction-to-Ambient (PCB Mount) ^⑤	—	40	

Static @ T_J = 25°C (unless otherwise specified)

	Parameter	Min.	Typ.	Max.	Units	Conditions
V _{(BR)DSS}	Drain-to-Source Breakdown Voltage	30	—	—	V	V _{GS} = 0V, I _D = 250μA
ΔV _{(BR)DSS} /ΔT _J	Breakdown Voltage Temp. Coefficient	—	23	—	mV/°C	Reference to 25°C, I _D = 1mA ②
R _{DS(on)}	Static Drain-to-Source On-Resistance	—	1.60	1.95	mΩ	V _{GS} = 10V, I _D = 148A ⑤
V _{GS(th)}	Gate Threshold Voltage	1.35	—	2.35	V	V _{DS} = V _{GS} , I _D = 150μA
I _{DSS}	Drain-to-Source Leakage Current	—	—	1	μA	V _{DS} = 30V, V _{GS} = 0V
		—	—	100		V _{DS} = 30V, V _{GS} = 0V, T _J = 125°C
I _{GSS}	Gate-to-Source Forward Leakage	—	—	100	nA	V _{GS} = 20V
	Gate-to-Source Reverse Leakage	—	—	-100		V _{GS} = -20V
R _G	Gate Resistance	—	0.9	—	Ω	

Dynamic Electrical Characteristics @ T_J = 25°C (unless otherwise specified)

g _{fs}	Forward Transconductance	428	—	—	S	V _{DS} = 10V, I _D = 148A
Q _g	Total Gate Charge	—	55	83	nC	I _D = 148A
Q _{gs}	Gate-to-Source Charge	—	28	—		V _{DS} = 15V
Q _{gd}	Gate-to-Drain Charge	—	11	—		V _{GS} = 4.5V
t _{d(on)}	Turn-On Delay Time	—	32	—	ns	V _{DD} = 20V
t _r	Rise Time	—	202	—		I _D = 148A
t _{d(off)}	Turn-Off Delay Time	—	33	—		R _G = 4.5Ω
t _f	Fall Time	—	102	—		V _{GS} = 4.5V
C _{iss}	Input Capacitance	—	8020	—	pF	V _{GS} = 0V
C _{oss}	Output Capacitance	—	1250	—		V _{DS} = 25V
C _{rss}	Reverse Transfer Capacitance	—	570	—		f = 1.0MHz
C _{oss eff.(ER)}	Effective Output Capacitance (Energy Related)	—	1560	—		V _{GS} = 0V, V _{DS} = 0V to 24V ⑦
C _{oss eff.(TR)}	Output Capacitance (Time Related)	—	1750	—		V _{GS} = 0V, V _{DS} = 0V to 24V ⑥

Diode Characteristics

	Parameter	Min.	Typ.	Max.	Units	Conditions
I _S	Continuous Source Current (Body Diode)	—	—	247 ①	A	MOSFET symbol showing the integral reverse p-n junction diode.
I _{SM}	Pulsed Source Current (Body Diode) ②	—	—	850 ③		
V _{SD}	Diode Forward Voltage	—	—	1.3	V	T _J = 25°C, I _S = 148A, V _{GS} = 0V
dv/dt	Peak Diode Recovery dv/dt ④	—	2.2	—	V/ns	T _J = 150°C, I _S = 148A, V _{DS} = 30V
t _{rr}	Reverse Recovery Time	—	32	—	ns	T _J = 25°C V _{DD} = 26V
		—	33	—		T _J = 125°C I _F = 148A,
Q _{rr}	Reverse Recovery Charge	—	24	—	nC	T _J = 25°C di/dt = 100A/μs ⑤
		—	26	—		T _J = 125°C
I _{RRM}	Reverse Recovery Current	—	1.2	—	A	T _J = 25°C

Notes:

- ① Calculated continuous current based on maximum allowable junction temperature. Bond wire current limit is 160A by source bonding technology. Note that current limitations arising from heating of the device leads may occur with some lead mounting arrangements. (Refer to AN-1140)
- ② Repetitive rating; pulse width limited by max. junction temperature.
- ③ Limited by T_{Jmax}, starting T_J = 25°C, L = 16μH, R_G = 50Ω, I_{AS} = 148A, V_{GS} = 10V.
- ④ I_{SD} ≤ 148A, di/dt ≤ 865A/μs, V_{DD} ≤ V_{(BR)DSS}, T_J ≤ 150°C.
- ⑤ Pulse width ≤ 400μs; duty cycle ≤ 2%.
- ⑥ C_{oss eff. (TR)} is a fixed capacitance that gives the same charging time as C_{oss} while V_{DS} is rising from 0 to 80% V_{DSS}.
- ⑦ C_{oss eff. (ER)} is a fixed capacitance that gives the same energy as C_{oss} while V_{DS} is rising from 0 to 80% V_{DSS}.
- ⑧ R_θ is measured at T_J approximately 90°C.
- ⑨ When mounted on 1" square PCB (FR-4 or G-10 Material). For recommended footprint and soldering techniques refer to application note #AN-994: <http://www.irf.com/technical-info/appnotes/an-994.pdf>
- ⑩ Pulse drain current is limited at 640A by source bonding technology.

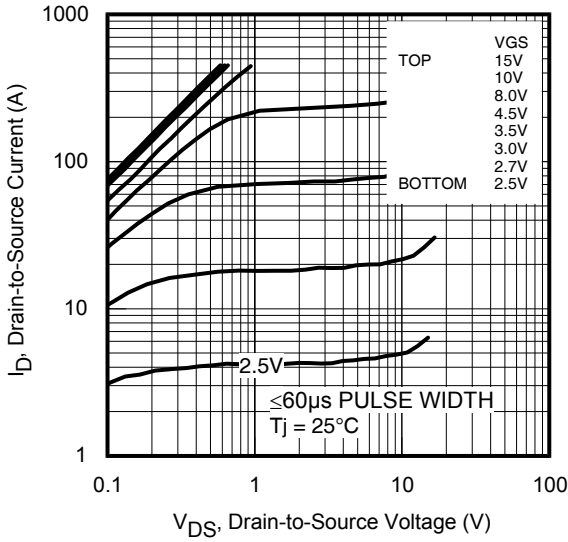

Fig 1. Typical Output Characteristics

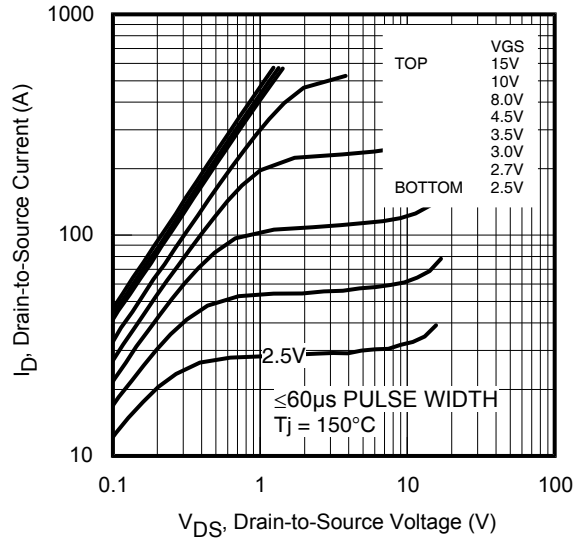

Fig 2. Typical Output Characteristics

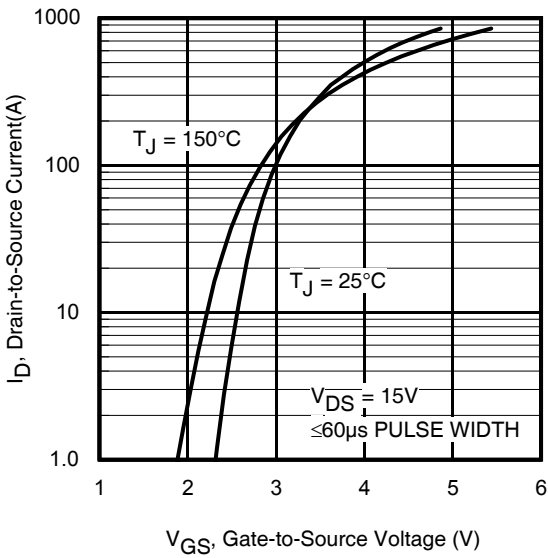

Fig 3. Typical Transfer Characteristics

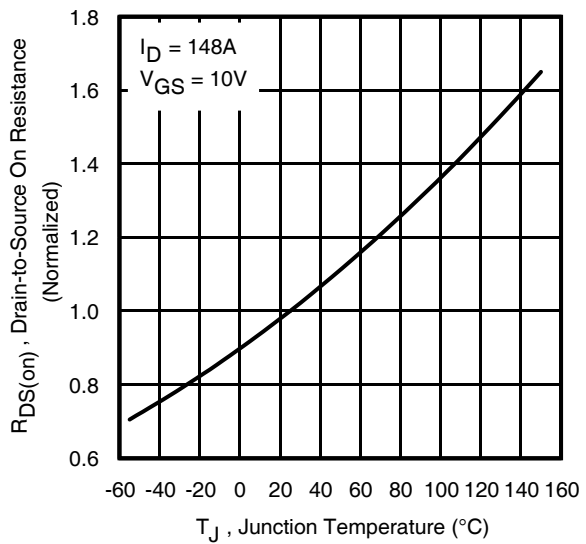

Fig 4. Normalized On-Resistance vs. Temperature

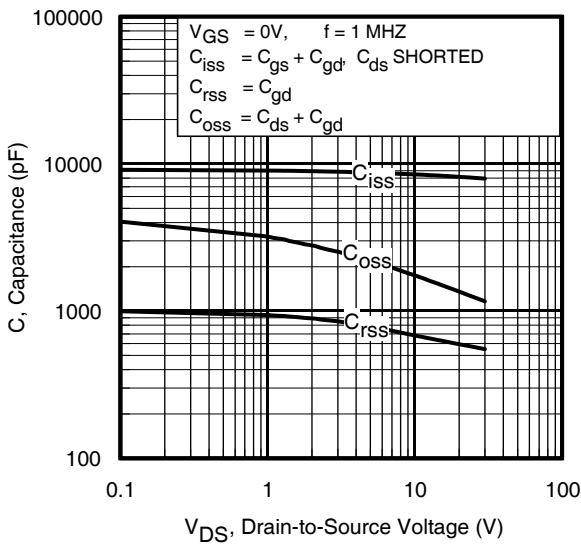

Fig 5. Typical Capacitance vs. Drain-to-Source Voltage

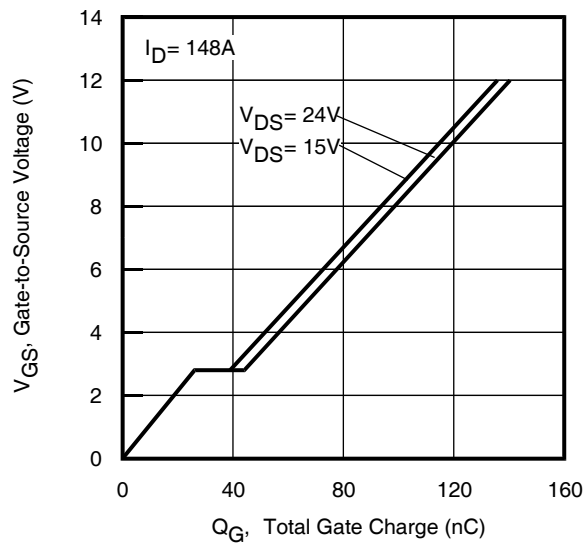

Fig 6. Typical Gate Charge vs. Gate-to-Source Voltage

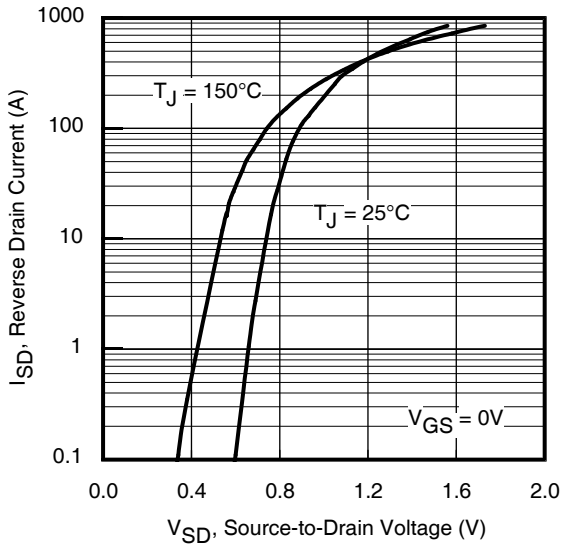

Fig 7. Typical Source-Drain Diode Forward Voltage

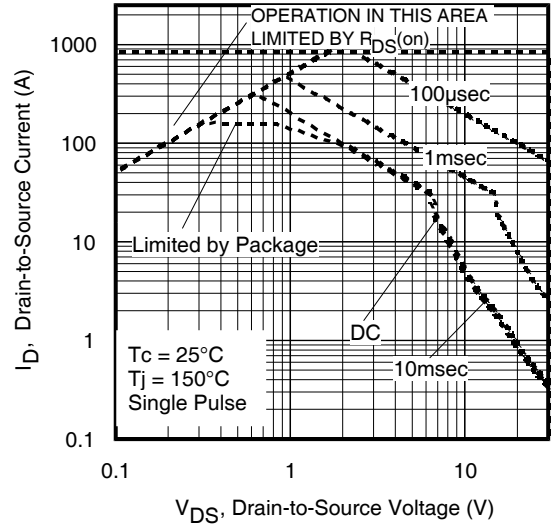

Fig 8. Maximum Safe Operating Area

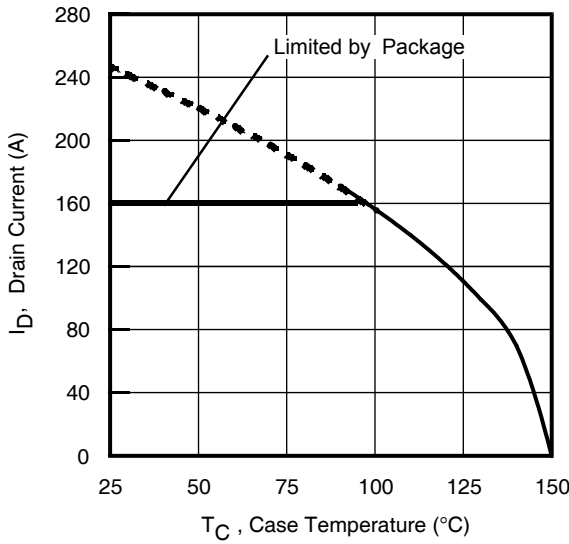

Fig 9. Maximum Drain Current vs. Case Temperature

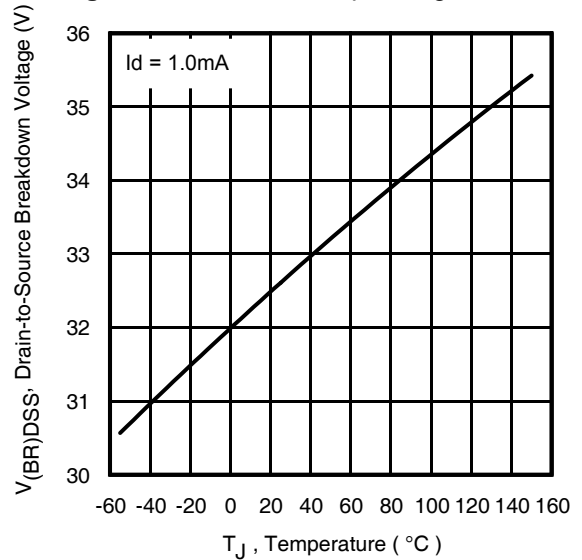

Fig 10. Drain-to-Source Breakdown Voltage

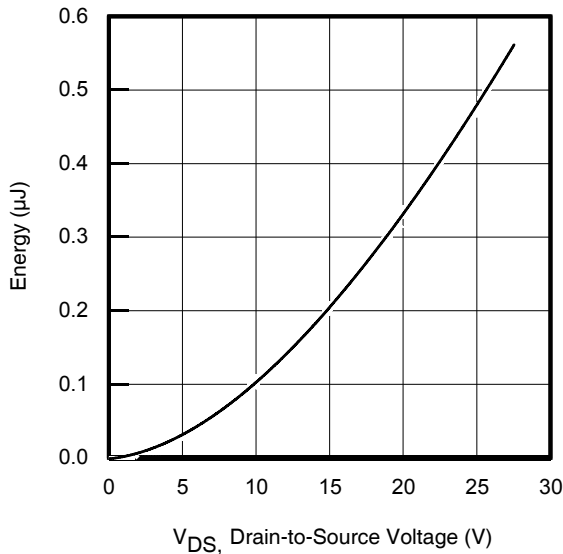

Fig 11. Typical C_{oss} Stored Energy

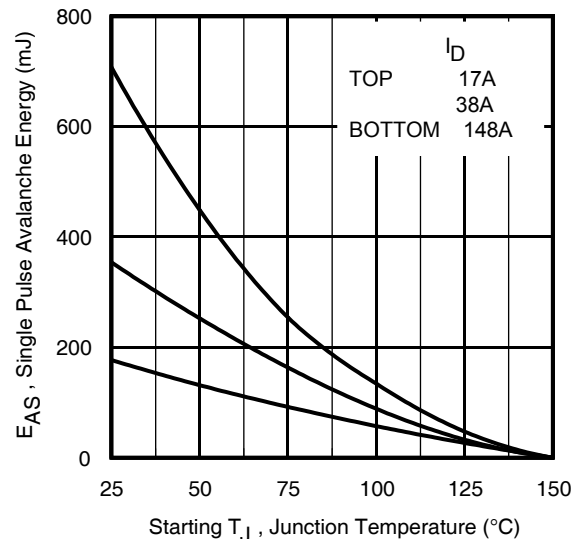

Fig 12. Maximum Avalanche Energy Vs. Drain Current

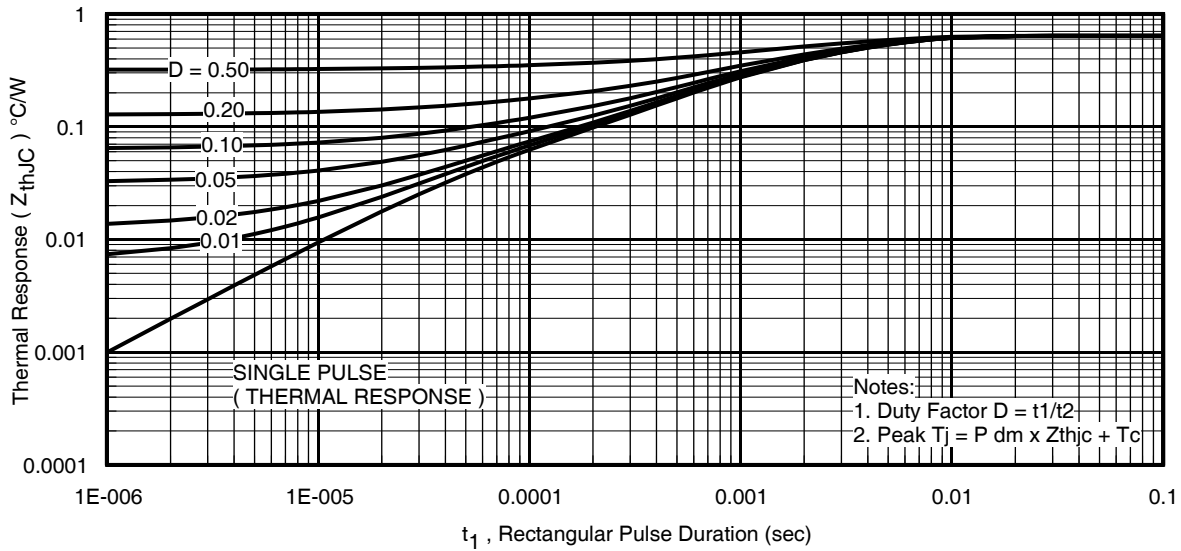

Fig 13. Maximum Effective Transient Thermal Impedance, Junction-to-Case

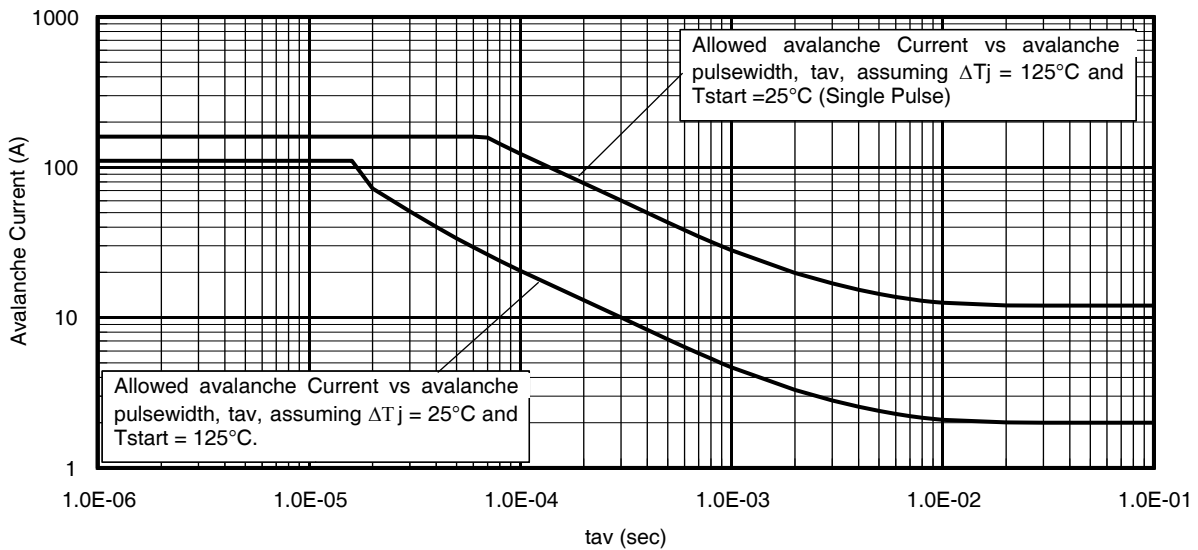

Fig 14. Single Avalanche Current vs. pulse Width

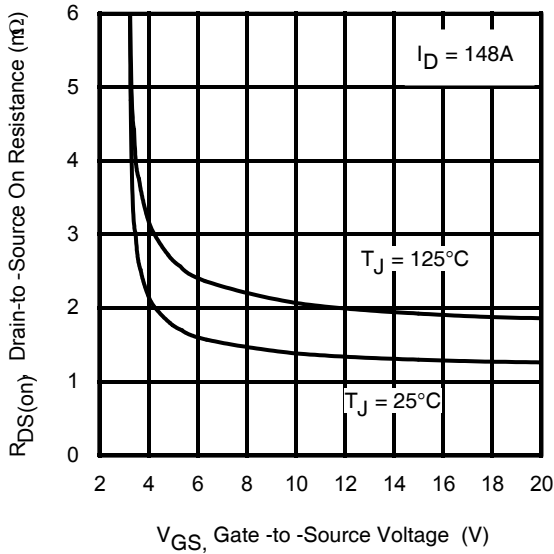

Fig 15. Typical On-Resistance vs. Gate Voltage

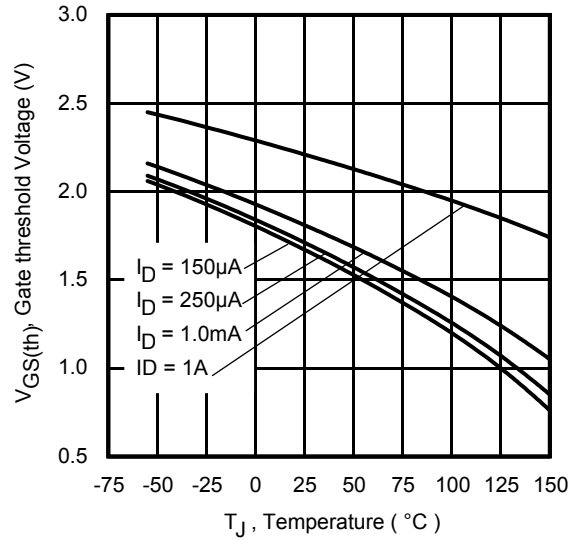

Fig 16. Threshold Voltage vs. Temperature

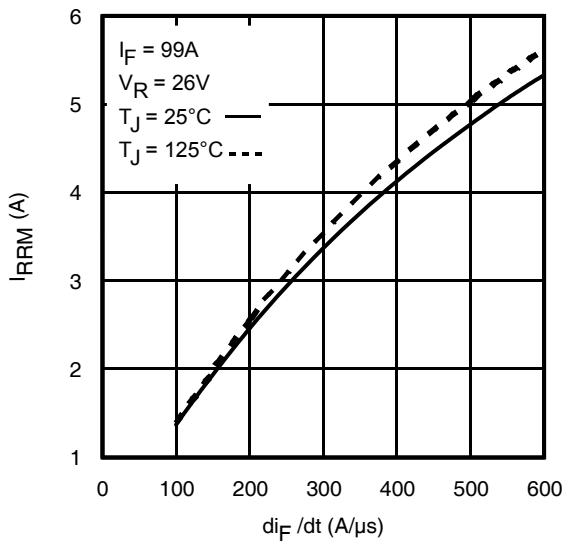

Fig 17. Typical Recovery Current vs. di/dt

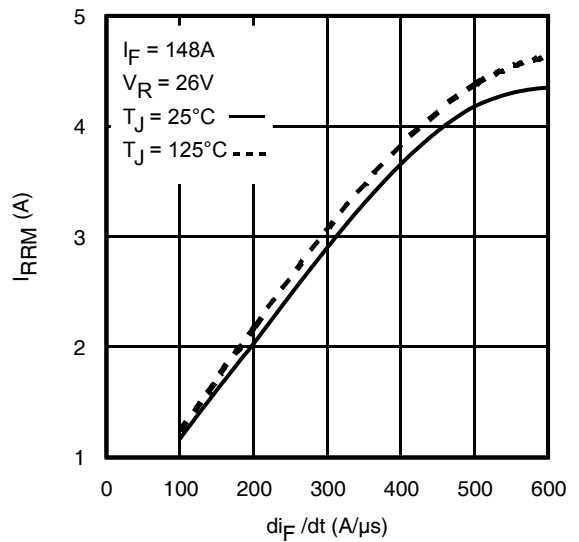

Fig 18. Typical Recovery Current vs. di/dt

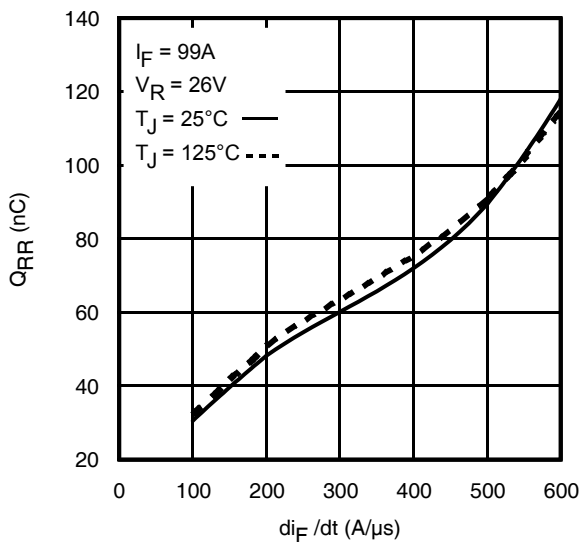

Fig 19. Typical Stored Charge vs. di/dt

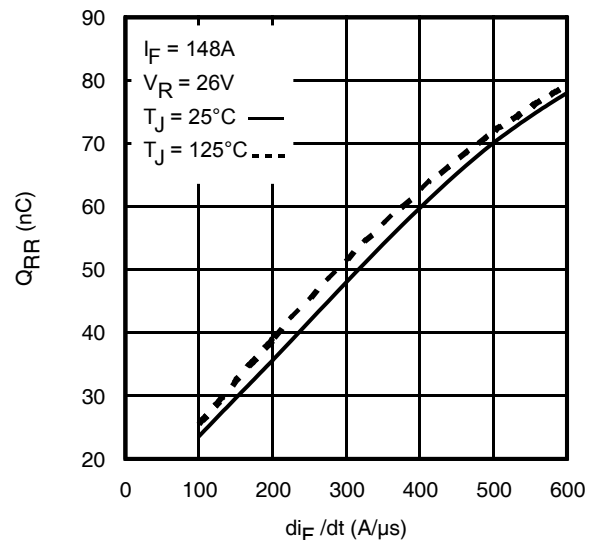

Fig 20. Typical Stored Charge vs. di/dt

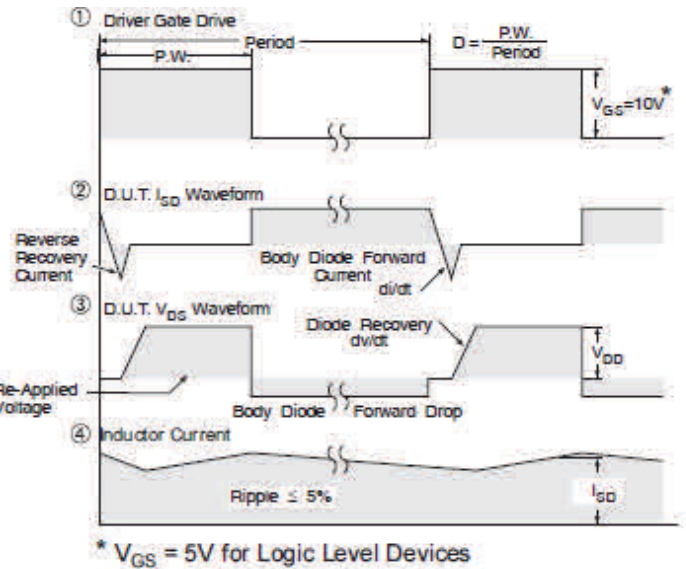
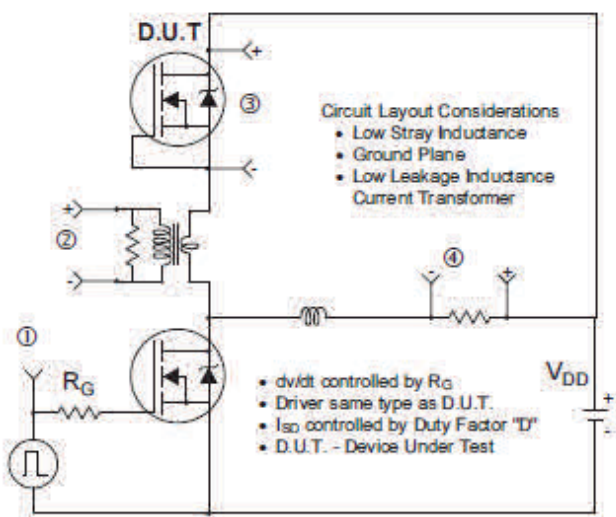

Fig 21. Peak Diode Recovery dv/dt Test Circuit for N-Channel HEXFET® Power MOSFETs

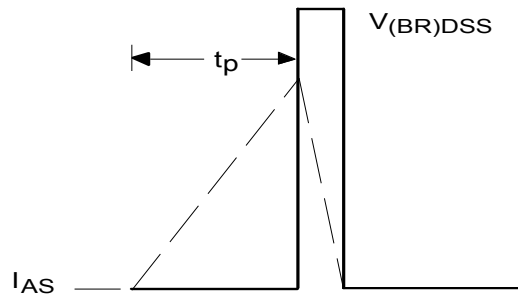
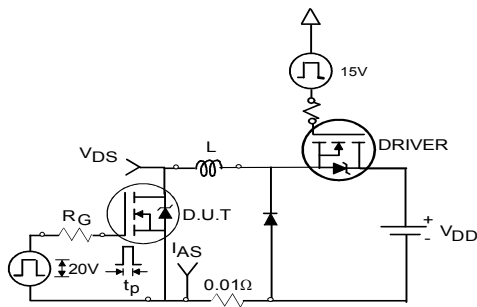

Fig 22a. Unclamped Inductive Test Circuit

Fig 22b. Unclamped Inductive Waveforms

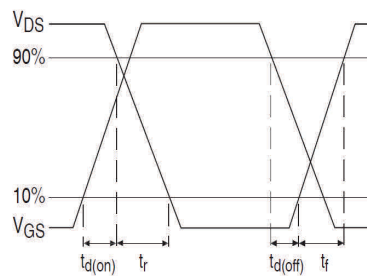
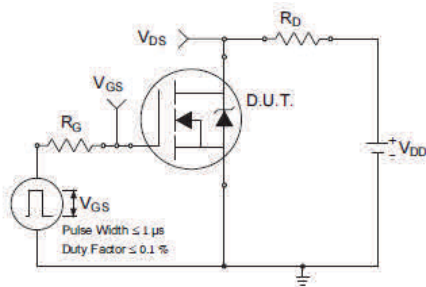

Fig 23a. Switching Time Test Circuit

Fig 23b. Switching Time Waveforms

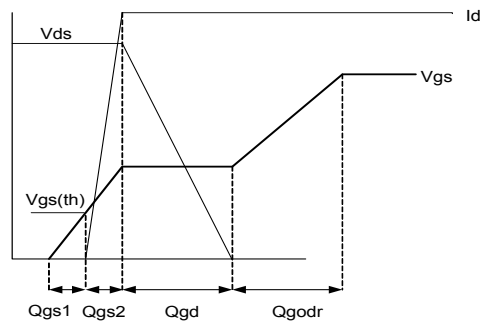
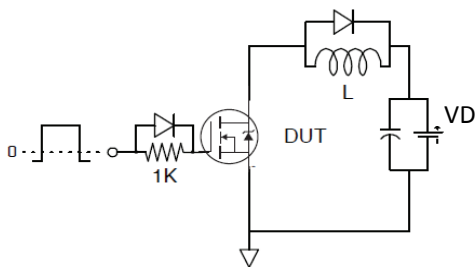
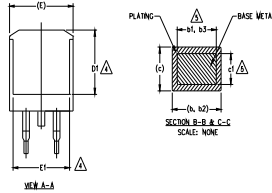
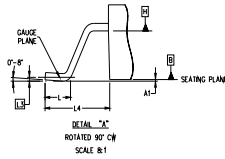
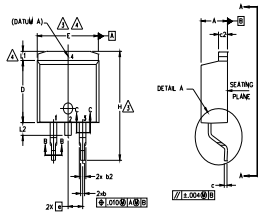

Fig 24a. Gate Charge Test Circuit

Fig 24b. Gate Charge Waveform

D²Pak (TO-263AB) Package Outline (Dimensions are shown in millimeters (inches))

NOTES:

1. DIMENSIONING AND TOLERANCING PER ASME Y14.5M-1994
2. DIMENSIONS ARE SHOWN IN MILLIMETERS [INCHES].
3. DIMENSION D & E DO NOT INCLUDE MOLD FLASH. MOLD FLASH SHALL NOT EXCEED 0.127 [.005"] PER SIDE. THESE DIMENSIONS ARE MEASURED AT THE OUTMOST EXTREMES OF THE PLASTIC BODY AT DATUM H.
4. THERMAL PAD CONTOUR OPTIONAL WITHIN DIMENSION E, L1, D1 & E1.
5. DIMENSION b1 AND c1 APPLY TO BASE METAL ONLY.
6. DATUM A & B TO BE DETERMINED AT DATUM PLANE H.
7. CONTROLLING DIMENSION: INCH.
8. OUTLINE CONFORMS TO JEDEC OUTLINE TO-263AB.

SYMBOL	DIMENSIONS				NOTES
	MILLIMETERS		INCHES		
	MIN.	MAX.	MIN.	MAX.	
A	4.06	4.83	.160	.190	
A1	0.00	0.254	.000	.010	
b	0.51	0.99	.020	.039	
b1	0.51	0.89	.020	.035	5
b2	1.14	1.78	.045	.070	
b3	1.14	1.73	.045	.068	5
c	0.38	0.74	.015	.029	
c1	0.38	0.58	.015	.023	5
c2	1.14	1.65	.045	.065	
D	8.38	9.65	.330	.380	
D1	6.86	-	.270	-	4
E	9.65	10.67	.380	.420	3,4
E1	6.22	-	.245	-	4
e	2.54 BSC		.100 BSC		
H	14.61	15.88	.575	.625	
L	1.78	2.79	.070	.110	
L1	-	1.65	-	.066	
L2	1.27	1.78	-	.070	
L3	0.25 BSC		.010 BSC		
L4	4.78	5.28	.188	.208	

LEAD ASSIGNMENTS
HEXFET

- 1.- GATE
- 2, 4.- DRAIN
- 3.- SOURCE

IGBTs, CoPACK

- 1.- GATE
- 2, 4.- COLLECTOR
- 3.- EMITTER

DIODES

- 1.- ANODE *
- 2, 4.- CATHODE
- 3.- ANODE

* PART DEPENDENT.

D²Pak (TO-263AB) Part Marking Information

EXAMPLE: THIS IS AN IRF530S WITH
LOT CODE 8024
ASSEMBLED ON WW 02, 2000
IN THE ASSEMBLY LINE "L"

Note: "P" in assembly line position
indicates "Lead - Free"

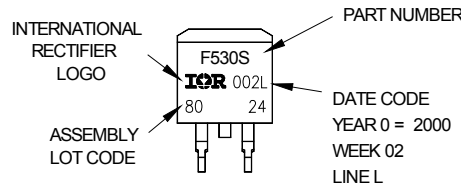

OR

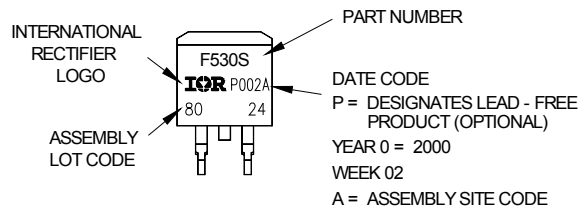

Note: For the most current drawing please refer to IR website at <http://www.irf.com/package/>

D²Pak (TO-263AB) Tape & Reel Information (Dimensions are shown in millimeters (inches))

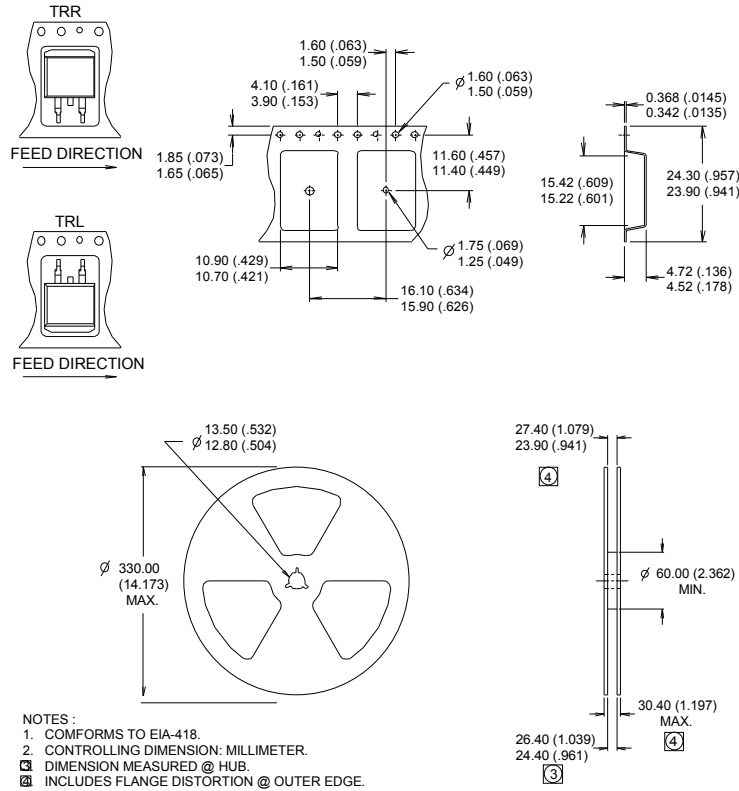

Note: For the most current drawing please refer to IR website at <http://www.irf.com/package/>

Qualification Information[†]

Qualification Level	Industrial	
RoHS Compliant	D ² Pak	MSL1
	Yes	

† Qualification standards can be found at International Rectifier's web site: <http://www.irf.com/product-info/reliability/>

†† Applicable version of JEDEC standard at the time of product release.