

MOSFET

Metal Oxide Semiconductor Field Effect Transistor

CoolMOS™ C6 650V

650V CoolMOS™ C6 Power Transistor
IPx65R099C6

Data Sheet

Rev. 2.0
Final

Industrial & Multimarket

1 Description

CoolMOS™ is a revolutionary technology for high voltage power MOSFETs, designed according to the superjunction (SJ) principle and pioneered by Infineon Technologies. CoolMOS™ C6 series combines the experience of the leading SJ MOSFET supplier with high class innovation. The resulting devices provide all benefits of a fast switching SJ MOSFET while not sacrificing ease of use. Extremely low switching and conduction losses make switching applications even more efficient, more compact, lighter and cooler.

Features

- Extremely low losses due to very low FOM $R_{ds(on)} \cdot Q_g$ and E_{oss}
- Very high commutation ruggedness
- Easy to use/drive
- Pb-free plating, Halogen free mold compound
- Qualified for industrial grade applications according to JEDEC (J-STD20 and JESD22)

Applications

PFC stages, hard switching PWM stages and resonant switching PWM stages for e.g. PC Silverbox, Adapter, LCD & PDP TV, Lighting, Server, Telecom, UPS and Solar.

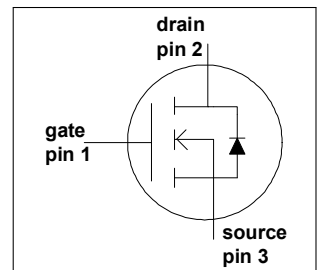
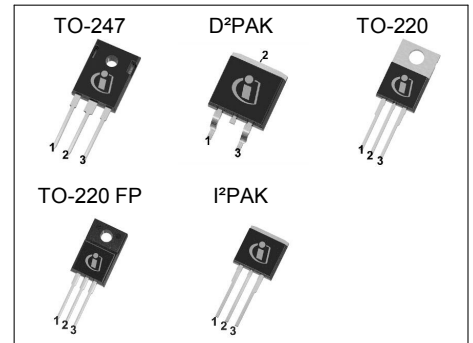

Table 1 Key Performance Parameters

Parameter	Value	Unit
$V_{DS} @ T_{j \max}$	700	V
$R_{DS(on),max}$	0.099	Ω
Q_g,typ	127	nC
$I_D,pulse$	115	A
$E_{oss} @ 400V$	10	μJ
Body diode di/dt	300	A/ μs

Type / Ordering Code	Package	Marking	Related Links
IPW65R099C6	PG-TO 247	65C6099	see Appendix A
IPB65R099C6	PG-TO 263		
IPP65R099C6	PG-TO 220		
IPA65R099C6	PG-TO 220 FullPAK		
IPI65R099C6	PG-TO 262		



Table of Contents

Description 2
Table of Contents 3
Maximum ratings 4
Thermal characteristics 5
Electrical characteristics 6
Electrical characteristics diagrams 8
Test Circuits 13
Package Outlines 14
Appendix A 19
Revision History 20
Disclaimer 20

2 Maximum ratings

at $T_j = 25^\circ\text{C}$, unless otherwise specified

Table 2 Maximum ratings

Parameter	Symbol	Values			Unit	Note / Test Condition
		Min.	Typ.	Max.		
Continuous drain current ¹⁾	I_D			38.0	A	$T_C = 25^\circ\text{C}$
				24.0		$T_C = 100^\circ\text{C}$
Pulsed drain current ²⁾	$I_{D,pulse}$			115	A	$T_C = 25^\circ\text{C}$
Avalanche energy, single pulse	E_{AS}			845	mJ	$I_D = 6.6\text{A}$, $V_{DS} = 50\text{V}$
Avalanche energy, repetitive	E_{AR}			1.28	mJ	$I_D = 6.6\text{A}$, $V_{DS} = 50\text{V}$
Avalanche current, repetitive	I_{AR}			6.6	A	
MOSFET dv/dt ruggedness	dv/dt			50	V/ns	$V_{DS} = 0 \dots 480\text{V}$
Gate source voltage	V_{GS}	-20		20	V	static
		-30		30		AC ($f > 1\text{ Hz}$)
Power dissipation (non FullPAK) TO-247, TO-220, I ² PAK	P_{tot}			278.0	W	$T_C = 25^\circ\text{C}$
Power dissipation (FullPAK) TO-220 FP	P_{tot}			35.0	W	$T_C = 25^\circ\text{C}$
Operating and storage temperature	T_j, T_{stg}	-55		150	$^\circ\text{C}$	
Mounting torque (non FullPAK) TO-247, TO-220, I ² PAK				60	Ncm	M3 and M3.5 screws
Mounting torque (FullPAK) TO-220 FP				50	Ncm	M2.5 screws
Continuous diode forward current	I_S			33.0	A	$T_C = 25^\circ\text{C}$
Diode pulse current	$I_{S,pulse}$			115	A	$T_C = 25^\circ\text{C}$
Reverse diode dv/dt ³⁾	dv/dt			15	V/ns	$V_{DS} = 0 \dots 480\text{V}$, $I_{SD} \leq I_D$, $T_j = 25^\circ\text{C}$
Maximum diode commutation speed	di_f/dt			300	A/ μs	

¹⁾ Limited by $T_{j,max}$. Maximum duty cycle $D=0.75$

²⁾ Pulse width t_p limited by $T_{j,max}$

³⁾ Identical low side and high side switch with identical R_G

3 Thermal characteristics

Table 3 Thermal characteristics TO-247, TO-220, I²PAK

Parameter	Symbol	Values			Unit	Note / Test Condition
		Min.	Typ.	Max.		
Thermal resistance, junction - case	R_{thJC}			0.45	°C/W	
Thermal resistance, junction - ambient	R_{thJA}			62	°C/W	leaded
Soldering temperature, wavesoldering only allowed at leads	T_{sold}			260	°C	1.6 mm (0.063 in.) from case for 10s

Table 4 Thermal characteristics TO-220 FP

Parameter	Symbol	Values			Unit	Note / Test Condition
		Min.	Typ.	Max.		
Thermal resistance, junction - case	R_{thJC}			3.6	°C/W	
Thermal resistance, junction - ambient	R_{thJA}			80	°C/W	leaded
Soldering temperature, wavesoldering only allowed at leads	T_{sold}			260	°C	1.6 mm (0.063 in.) from case for 10s

Table 5 Thermal characteristics D²PAK

Parameter	Symbol	Values			Unit	Note / Test Condition
		Min.	Typ.	Max.		
Thermal resistance, junction - case	R_{thJC}			0.45	°C/W	
Thermal resistance, junction - ambient ¹⁾	R_{thJA}			62	°C/W	SMD version, device on PCB, minimal footprint
			35			SMD version, device on PCB, 6cm ² cooling area
Soldering temperature, wave- & reflowsoldering allowed	T_{sold}			260	°C	reflow MSL

¹⁾ Device on 40mm*40mm*1.5mm one layer epoxy PCB FR4 with 6cm² copper area (thickness 70µm) for drain connection. PCB is vertical without air stream cooling.

4 Electrical characteristics

at $T_j = 25^\circ\text{C}$, unless otherwise specified

Table 6 Static characteristics

Parameter	Symbol	Values			Unit	Note / Test Condition
		Min.	Typ.	Max.		
Drain-source breakdown voltage	$V_{(BR)DSS}$	650			V	$V_{GS} = 0V, I_D = 1mA$
Gate threshold voltage	$V_{GS(th)}$	2.5	3	3.5	V	$V_{DS} = V_{GS}, I_D = 1.2mA$
Zero gate voltage drain current	I_{DSS}			1	μA	$V_{DS} = 650V, V_{GS} = 0V, T_j = 25^\circ C$
			10			$V_{DS} = 650V, V_{GS} = 0V, T_j = 150^\circ C$
Gate-source leakage current	I_{GSS}			100	nA	$V_{GS} = 20V, V_{DS} = 0V$
Drain-source on-state resistance	$R_{DS(on)}$		0.089	0.099	Ω	$V_{GS} = 10V, I_D = 12.8A, T_j = 25^\circ C$
			0.231			$V_{GS} = 10V, I_D = 12.8A, T_j = 150^\circ C$
Gate resistance	R_G		1.7		Ω	$f = 1MHz, \text{open drain}$

Table 7 Dynamic characteristics

Parameter	Symbol	Values			Unit	Note / Test Condition
		Min.	Typ.	Max.		
Input capacitance	C_{iss}		2780		pF	$V_{GS} = 0V, V_{DS} = 100V, f = 1MHz$
Output capacitance	C_{oss}		142		pF	
Effective output capacitance, energy related ¹⁾	$C_{o(er)}$		110		pF	$V_{GS} = 0V, V_{DS} = 0 \dots 480V$
Effective output capacitance, time related ²⁾	$C_{o(tr)}$		525		pF	$I_D = \text{constant}, V_{GS} = 0V, V_{DS} = 0 \dots 480V$
Turn-on delay time	$t_{d(on)}$		10.6		ns	$V_{DD} = 400V, V_{GS} = 13V, I_D = 19.2A, R_G = 1.7\Omega$ (see table 21)
Rise time	t_r		9		ns	
Turn-off delay time	$t_{d(off)}$		77		ns	
Fall time	t_f		6		ns	

Table 8 Gate charge characteristics

Parameter	Symbol	Values			Unit	Note / Test Condition
		Min.	Typ.	Max.		
Gate to source charge	Q_{gs}		15		nC	$V_{DD} = 480V, I_D = 19.2A, V_{GS} = 0 \text{ to } 10V$
Gate to drain charge	Q_{gd}		65		nC	
Gate charge total	Q_g		127		nC	
Gate plateau voltage	$V_{plateau}$		5.5		V	

¹⁾ $C_{o(er)}$ is a fixed capacitance that gives the same stored energy as C_{oss} while V_{DS} is rising from 0 to 80% $V_{(BR)DSS}$

²⁾ $C_{o(tr)}$ is a fixed capacitance that gives the same charging time as C_{oss} while V_{DS} is rising from 0 to 80% $V_{(BR)DSS}$



Table 9 Reverse diode characteristics

Parameter	Symbol	Values			Unit	Note / Test Condition
		Min.	Typ.	Max.		
Diode forward voltage	V_{SD}		0.9		V	$V_{GS} = 0V, I_F = 19.2A, T_j = 25^\circ C$
Reverse recovery time	t_{rr}		615		ns	$V_R = 400V, I_F = 19.2A,$ $di_F/dt = 100A/\mu s$ (see table 20)
Reverse recovery charge	Q_{rr}		14.8		μC	
Peak reverse recovery current	I_{rrm}		46		A	

5 Electrical characteristics diagrams

Table 10

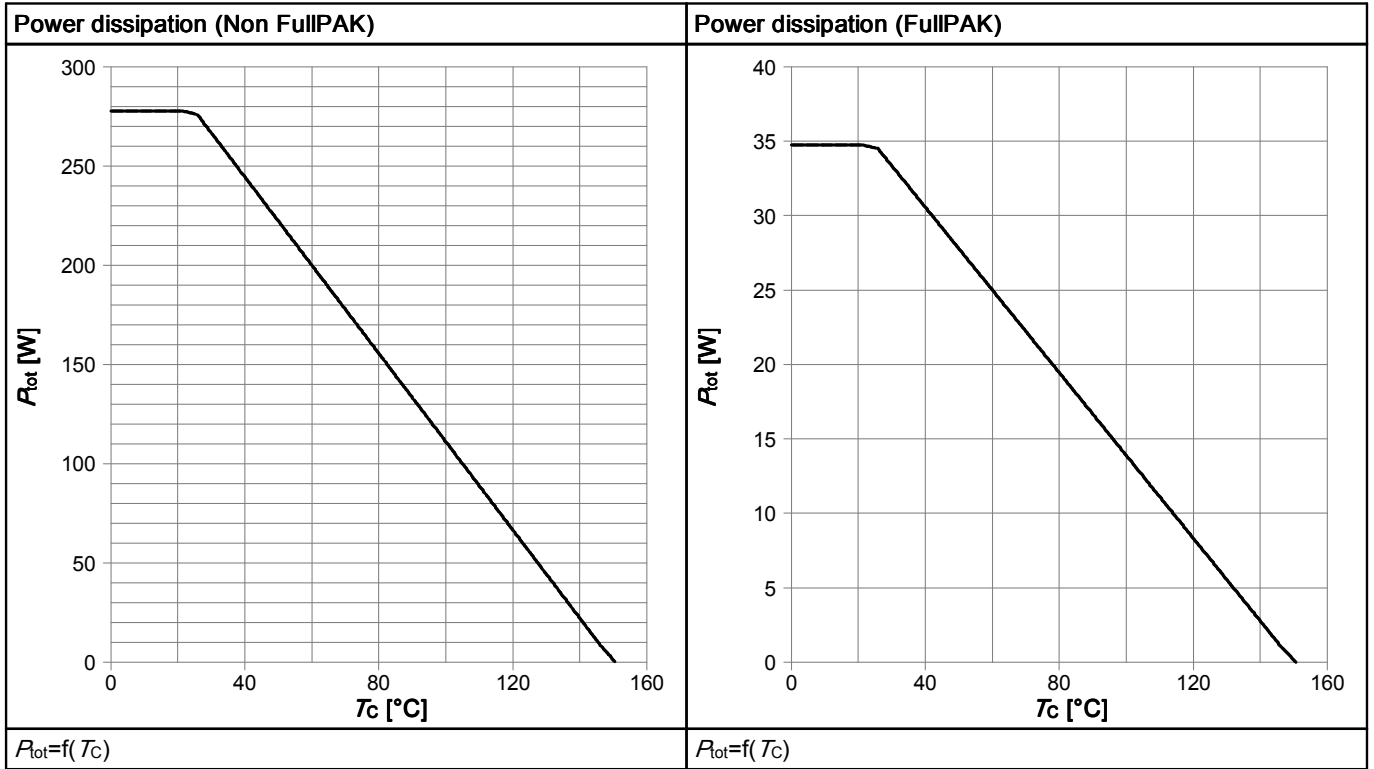

Table 11

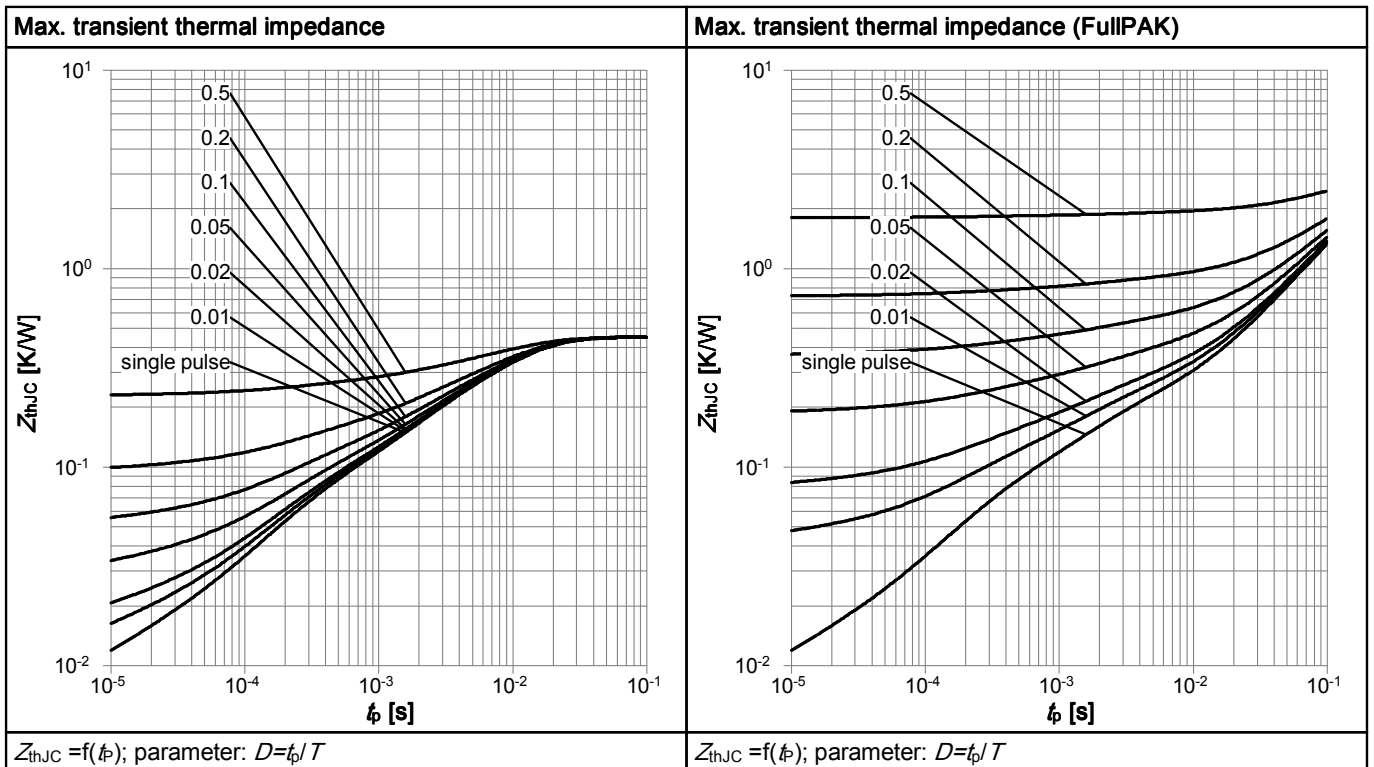

Table 12

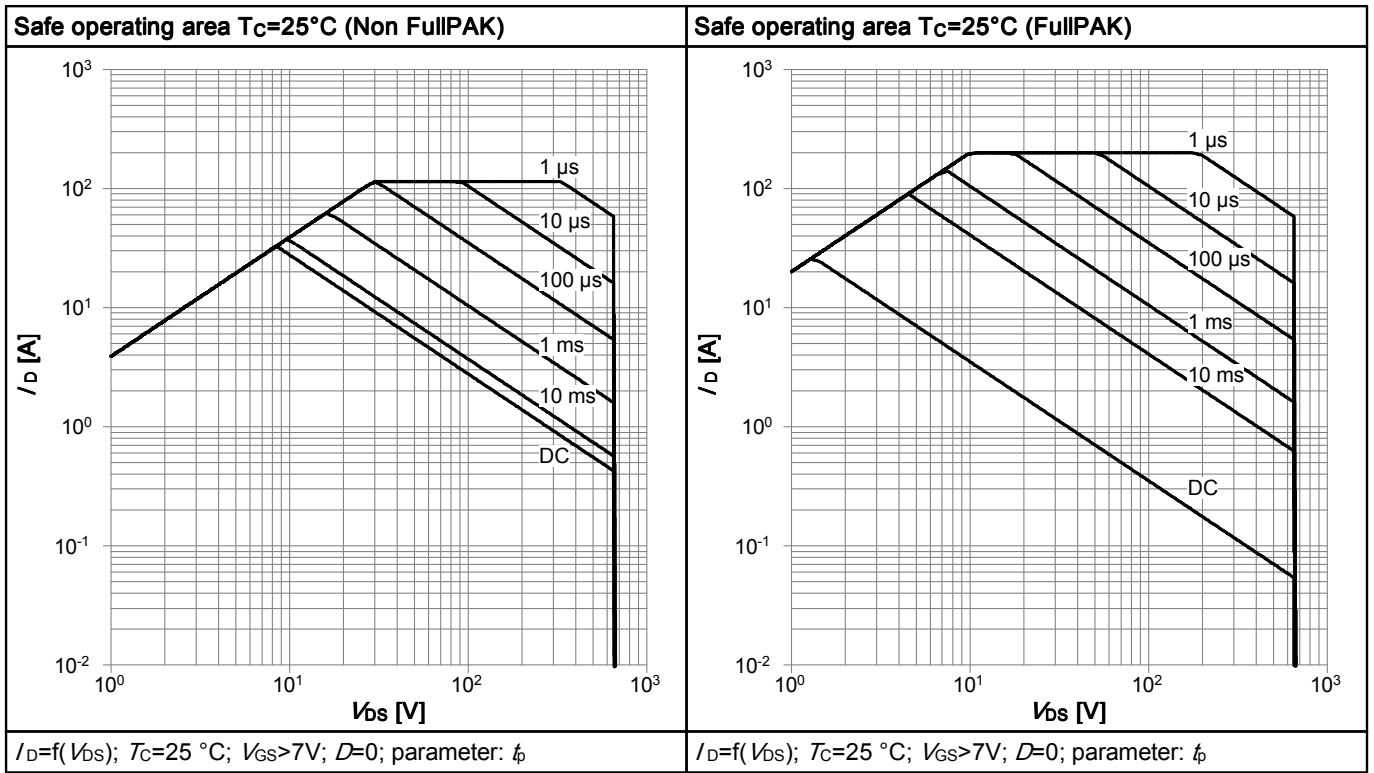

Table 13

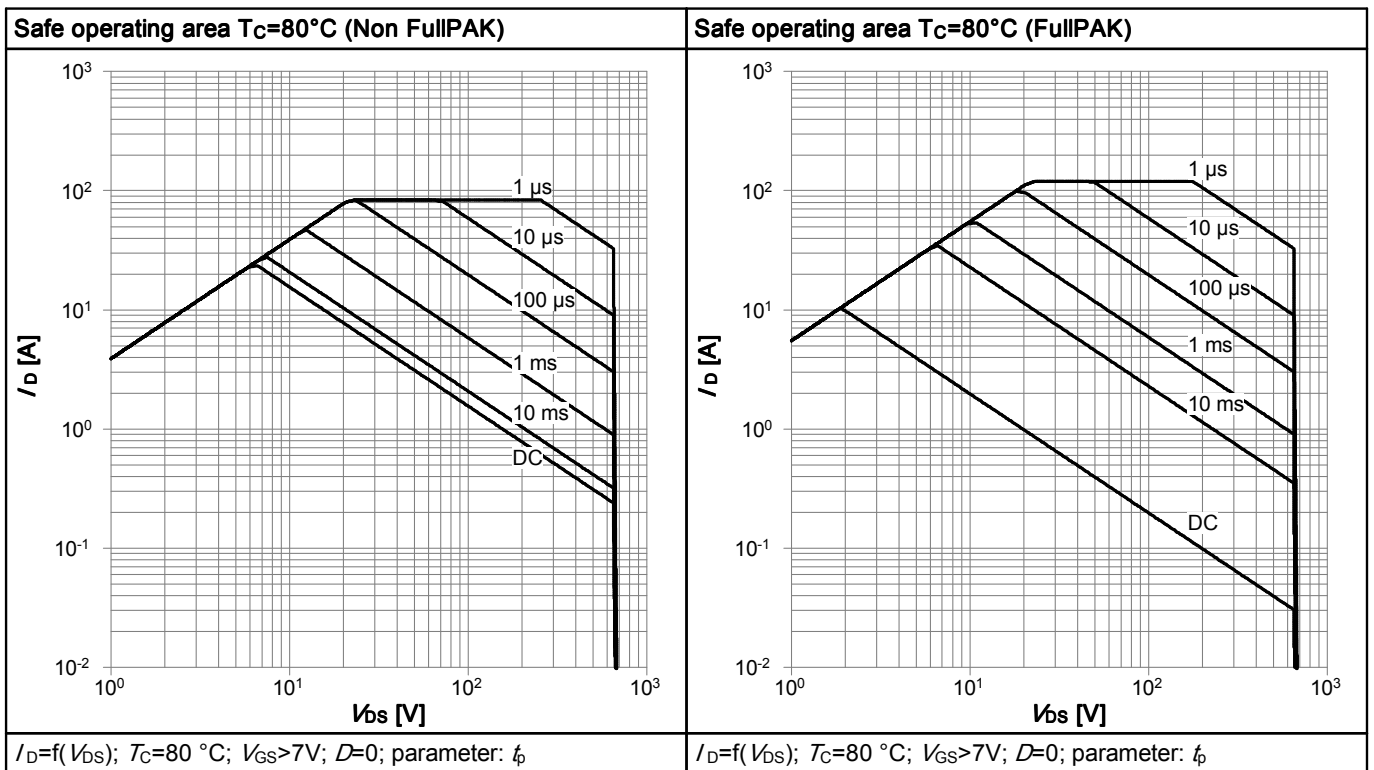

Table 14

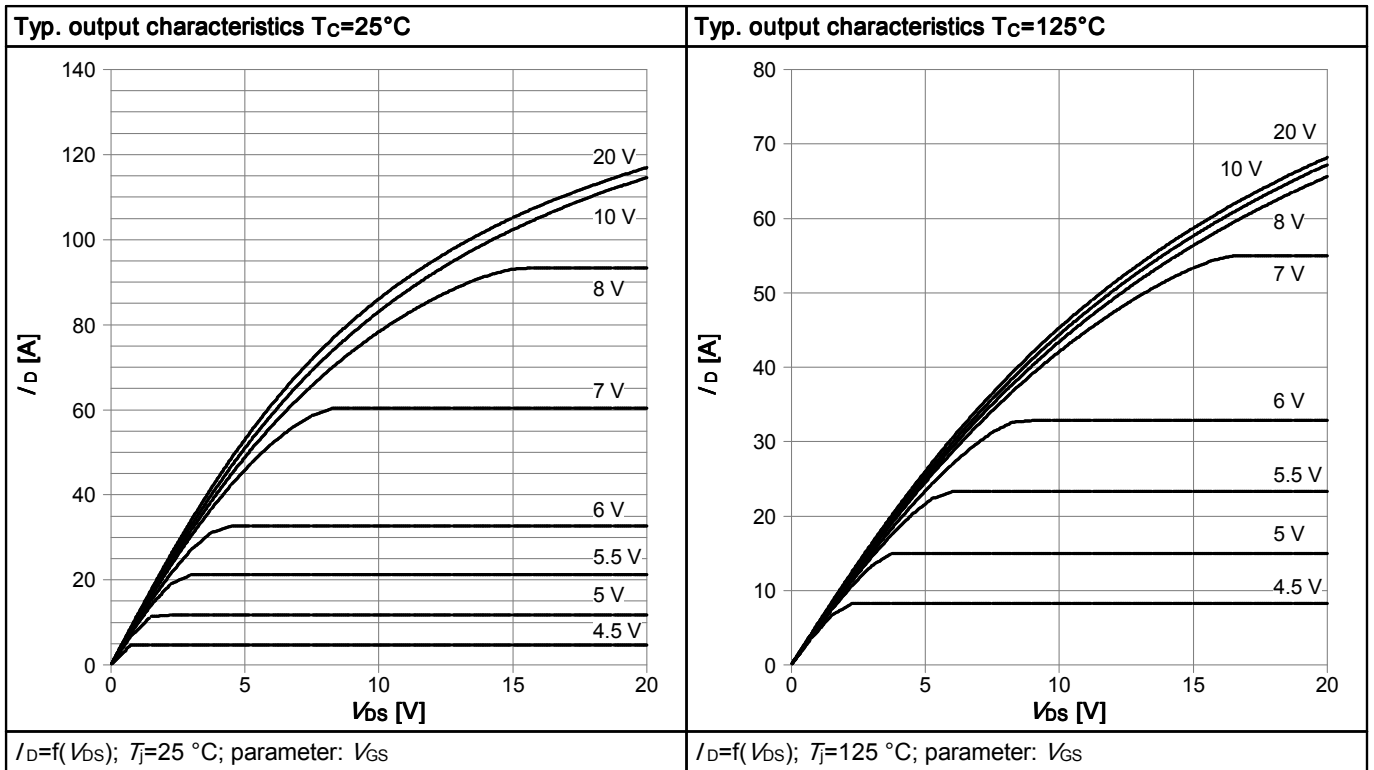

Table 15

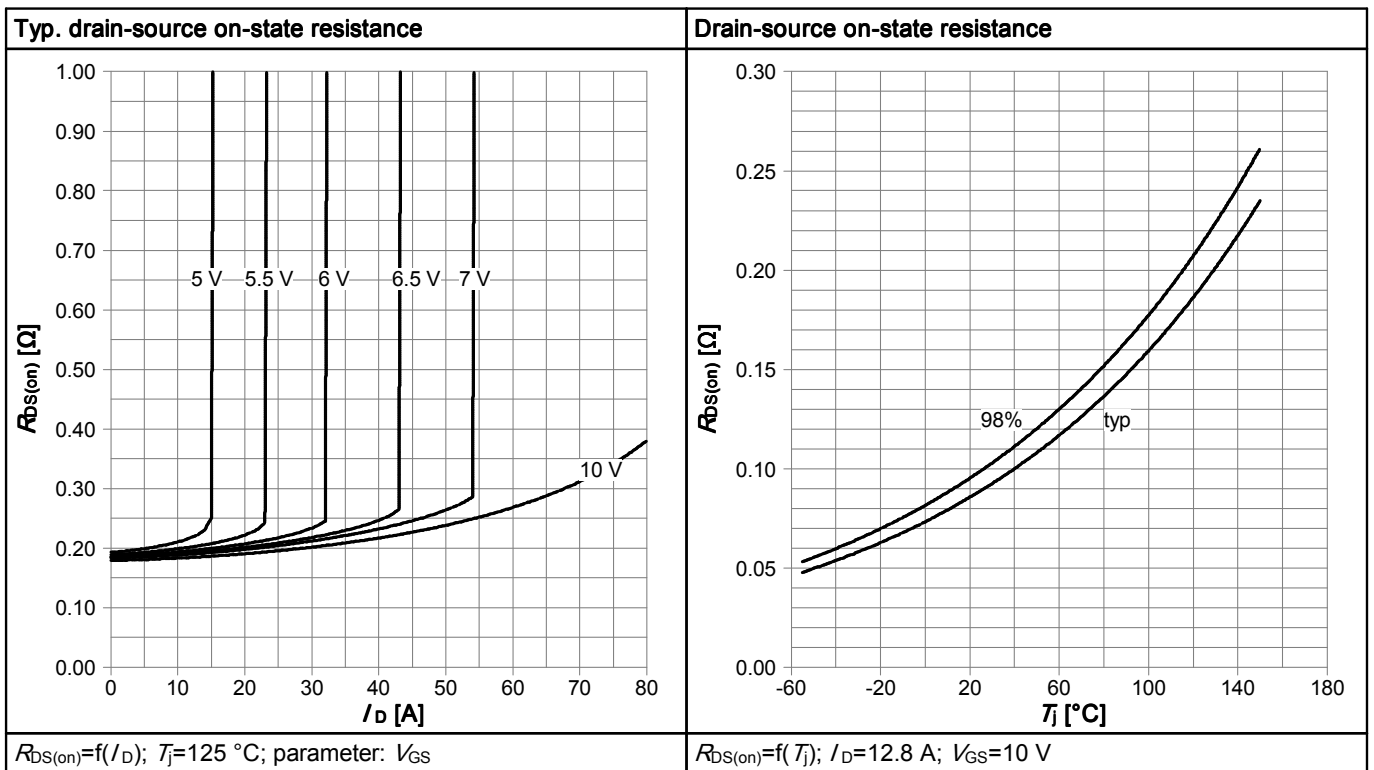

Table 16

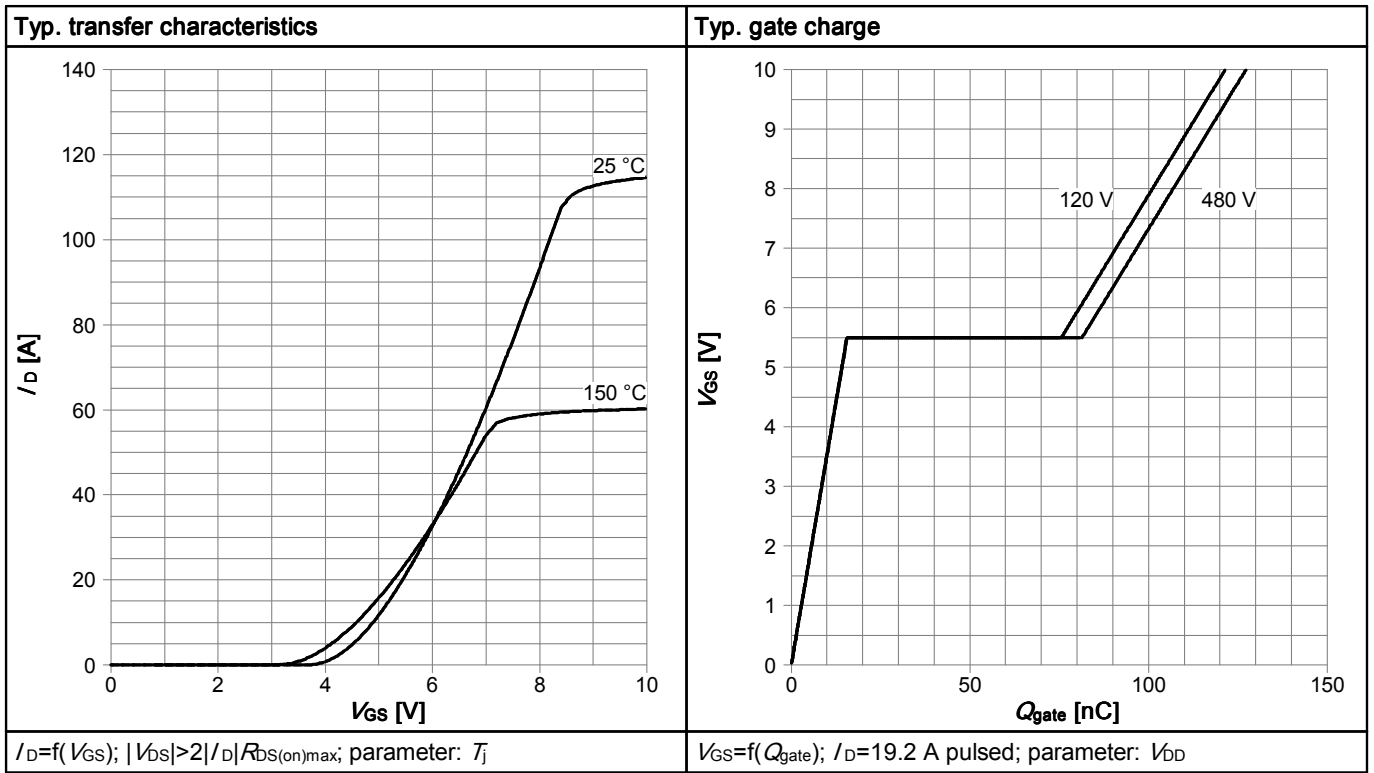

Table 17

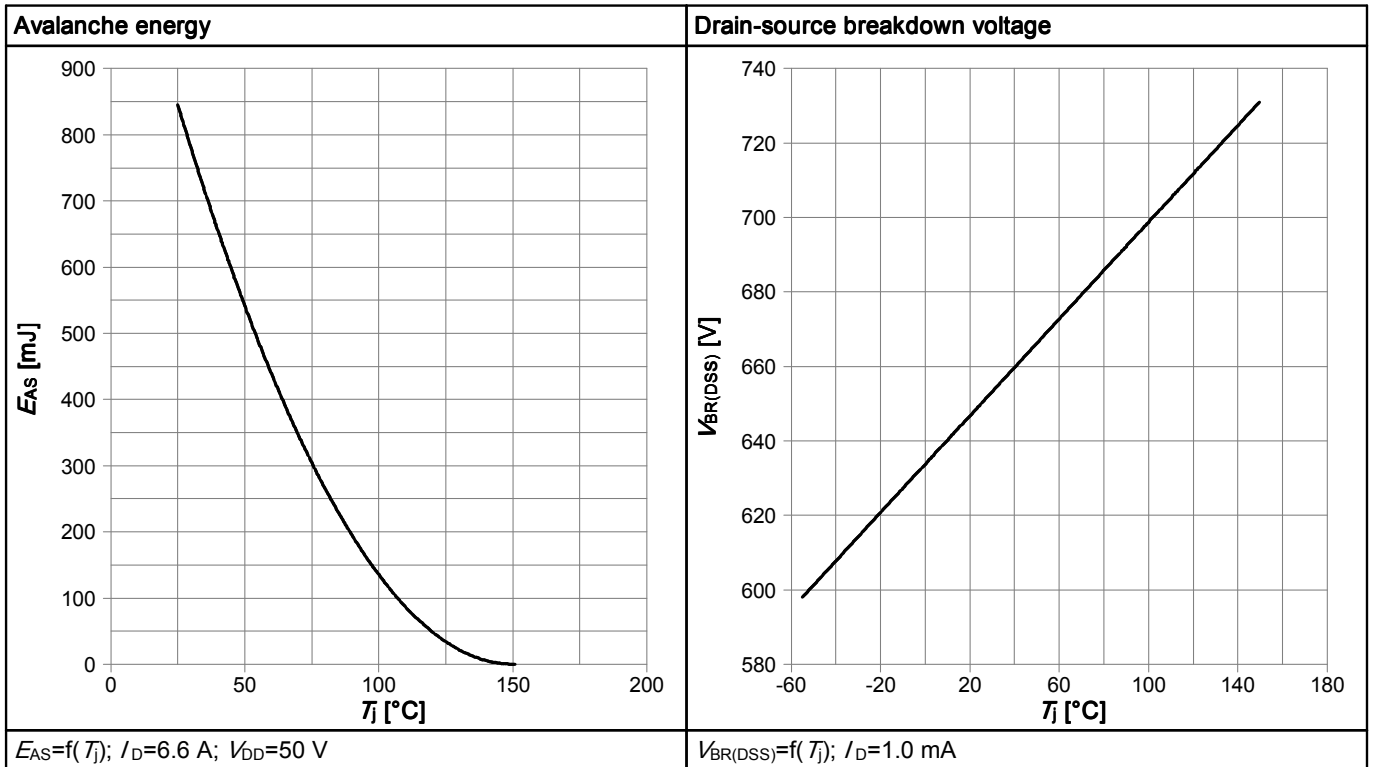

Table 18

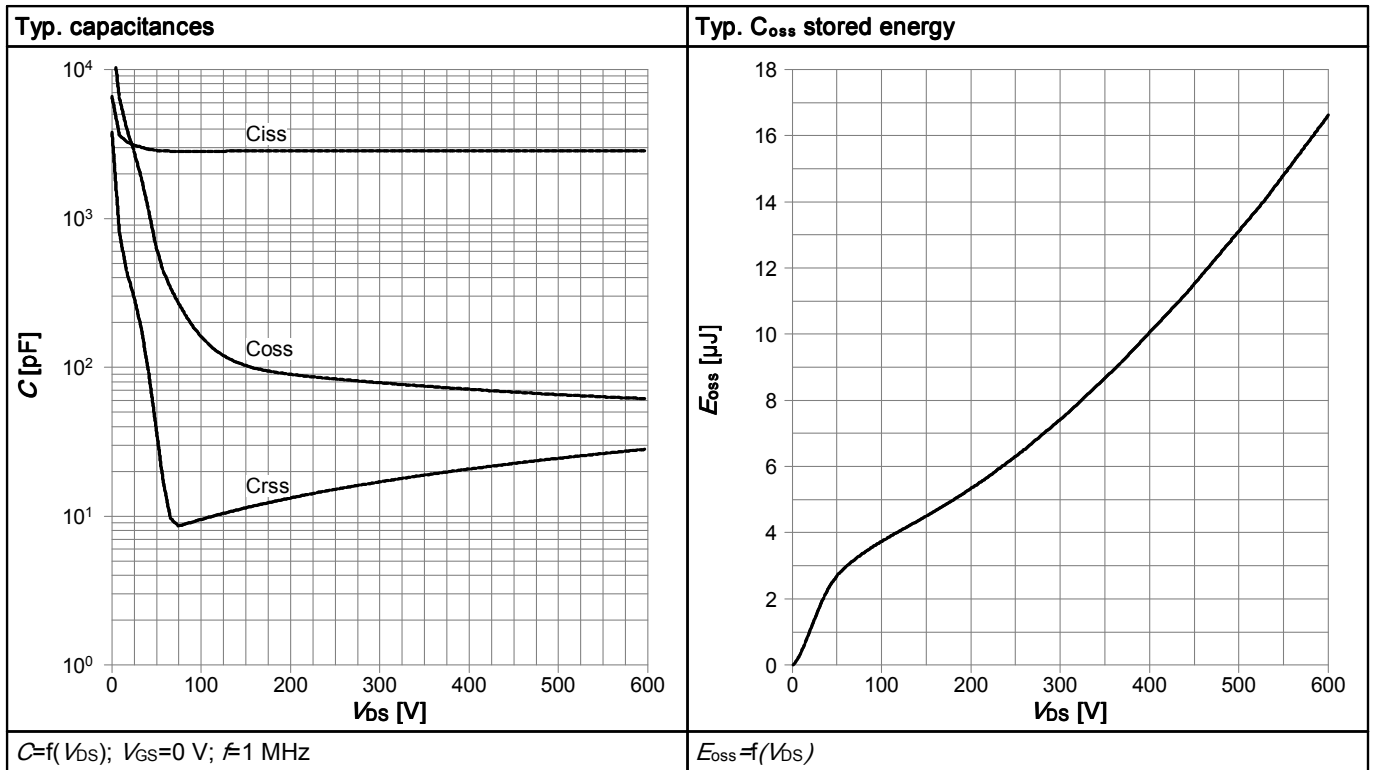
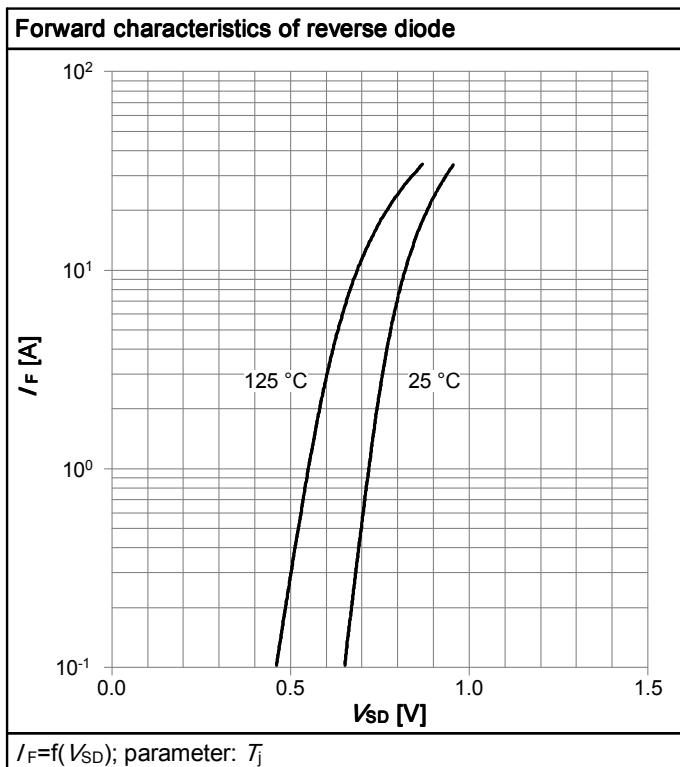

Table 19



6 Test Circuits

Table 20 Diode characteristics



Table 21 Switching times

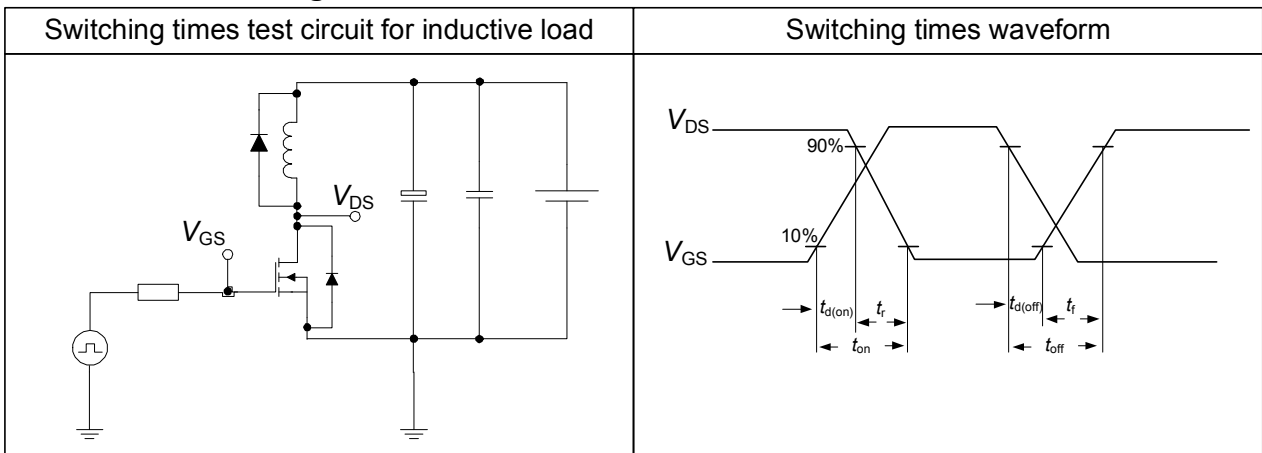
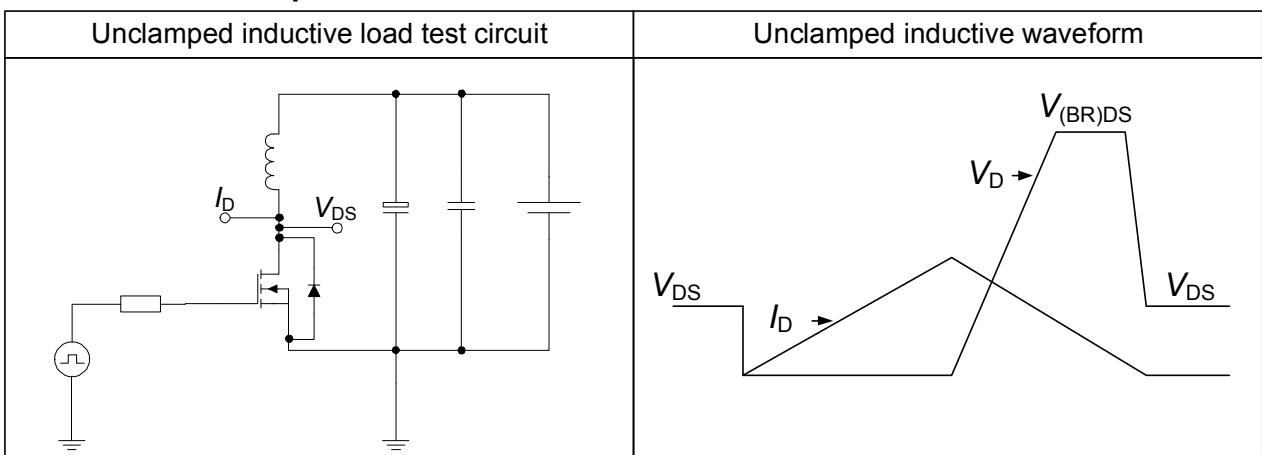

Table 22 Unclamped inductive



7 Package Outlines

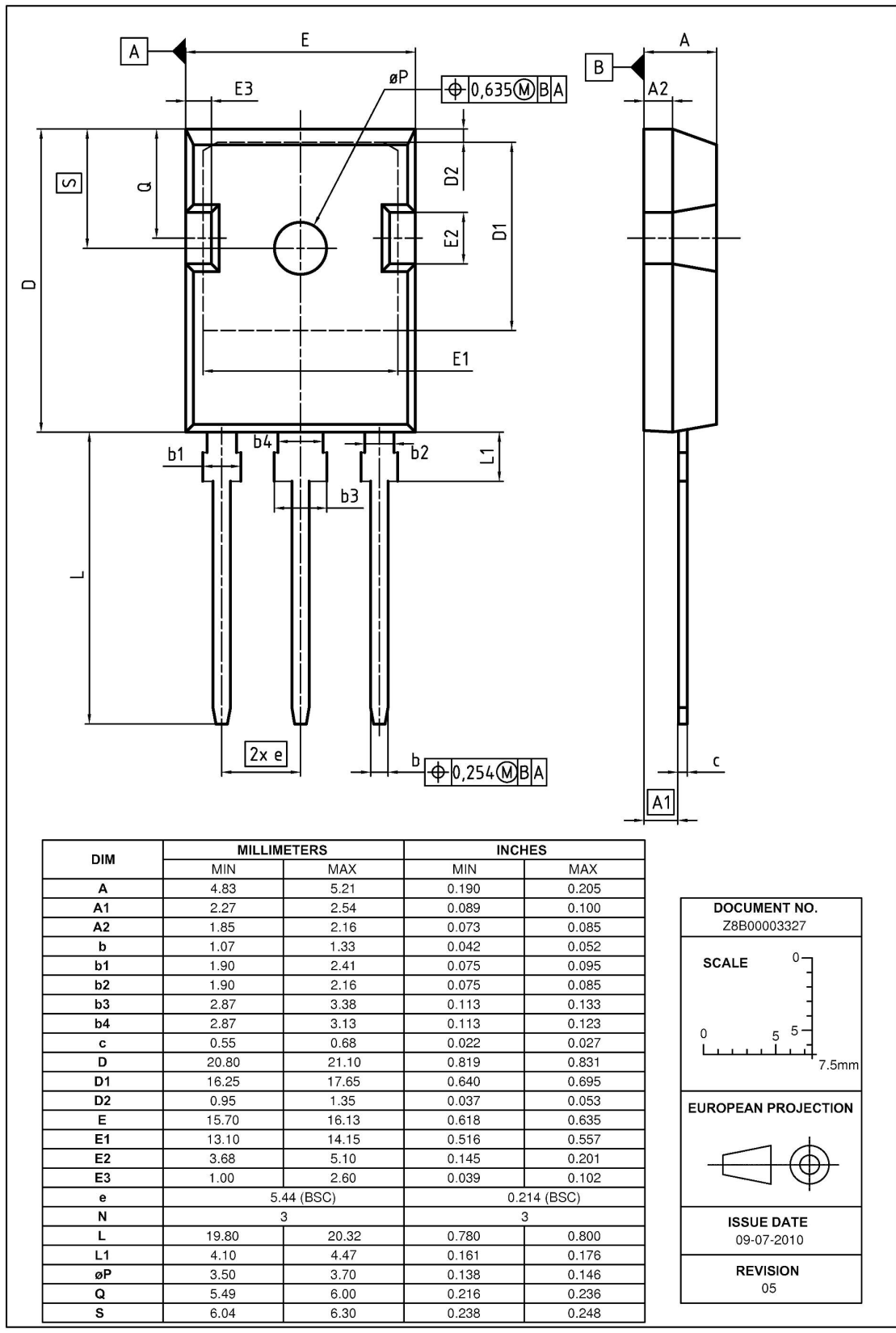

Figure 1 Outline PG-TO 247, dimensions in mm/inches



Figure 2 Outline PG-TO 263, dimensions in mm/inches



Figure 3 Outline PG-TO 220, dimensions in mm/inches

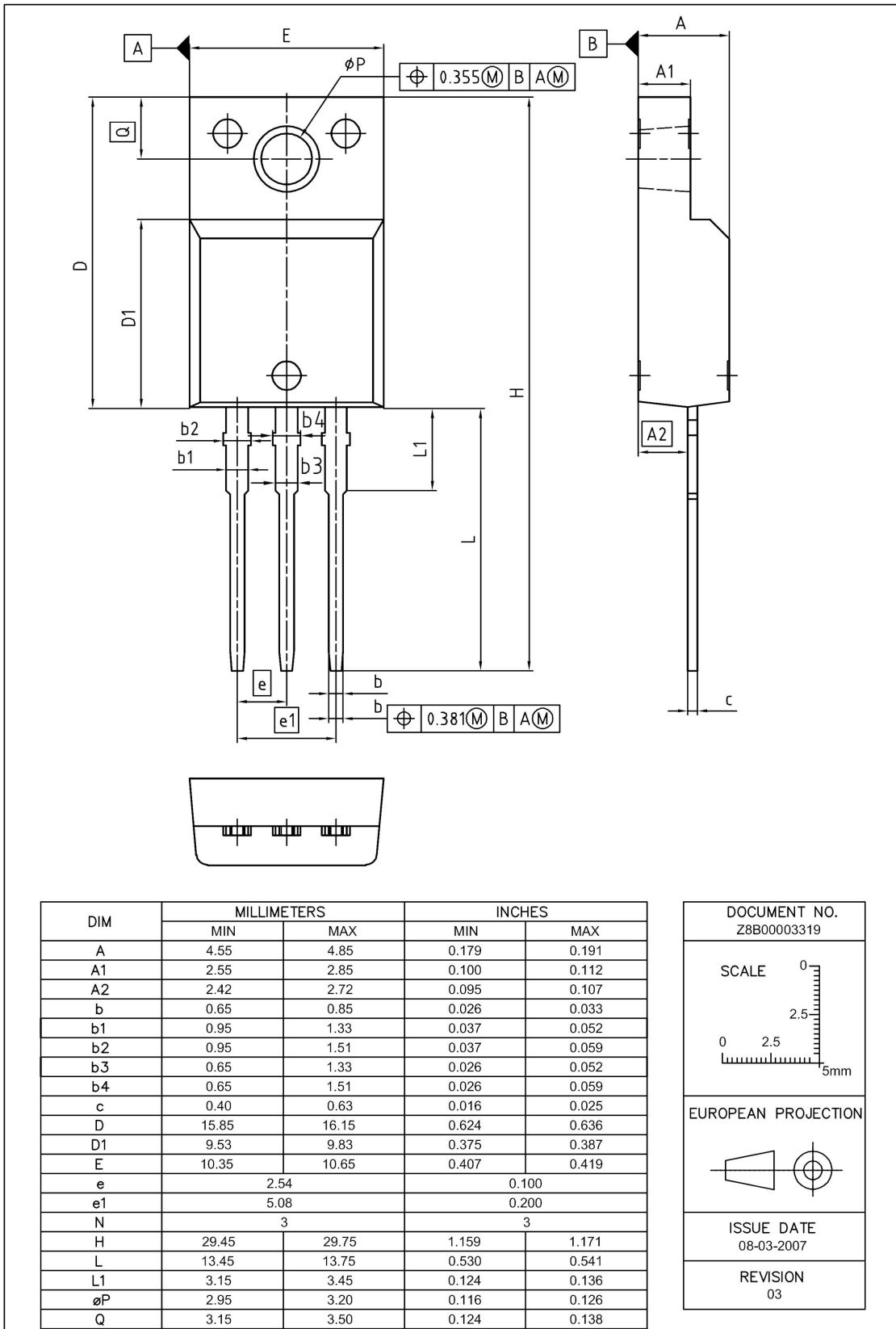

Figure 4 Outline PG-TO 220 FullPAK, dimensions in mm/inches

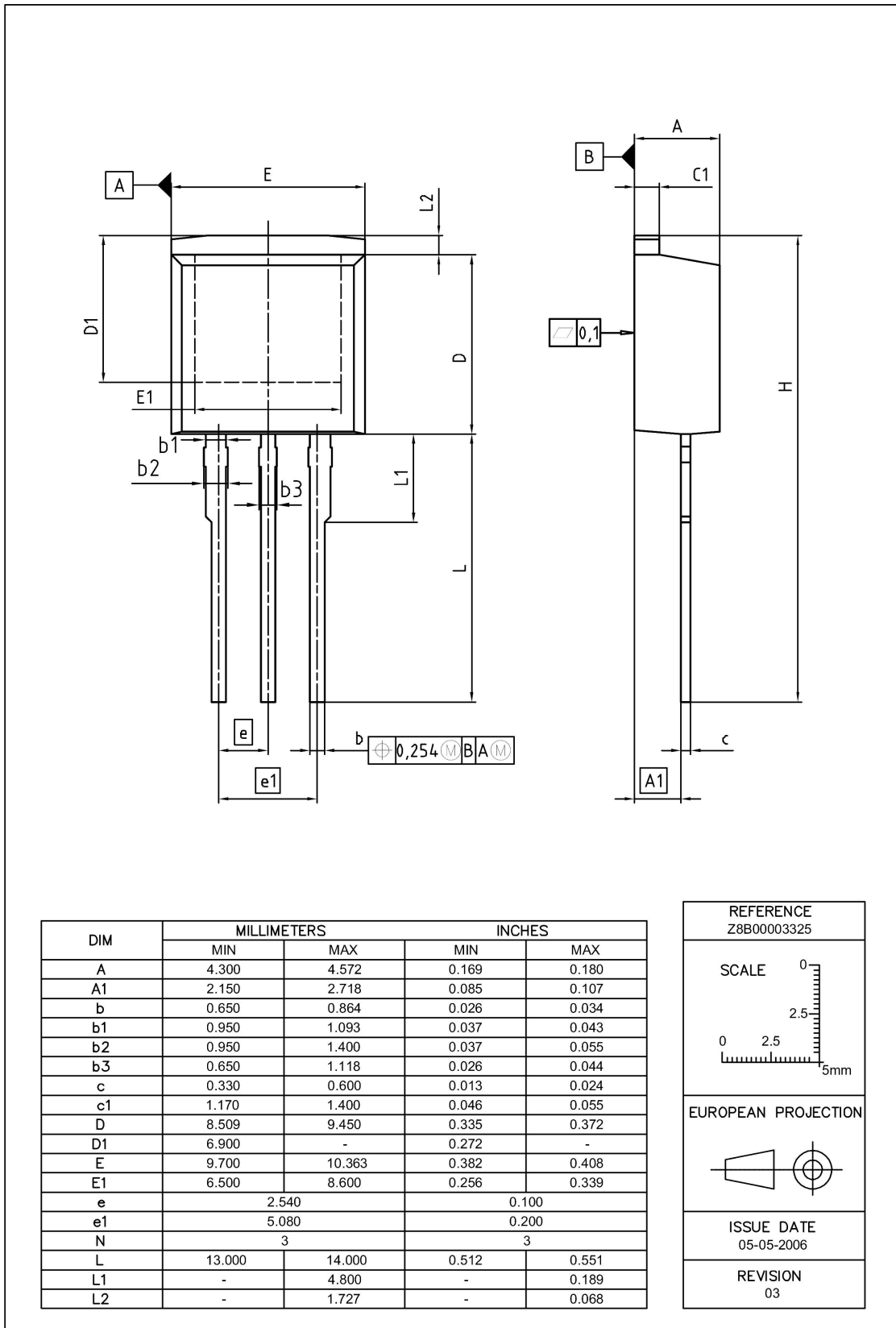

Figure 5 Outline PG-TO 262, dimensions in mm/inches

8 Appendix A

Table 23 Related Links

- **IFX C6 Product Brief:**

<http://www.infineon.com/dgdl/Product+Brief+600V+CoolMOS+C6+.pdf?folderId=db3a3043156fd5730115939eb6b506db>

- **IFX C6 Portfolio:**

http://www.infineon.com/cms/en/product/findProductTypeByName.html?q=ip*c6

- **IFX CoolMOS Webpage:**

<http://www.infineon.com/cms/en/product/channel.html?channel=ff80808112ab681d0112ab6a628704d8>

- **IFX Design Tools:**

<http://www.infineon.com/cms/en/product/promopages/designtools/index.html>



Revision History

IPW65R099C6, IPB65R099C6, IPP65R099C6, IPA65R099C6, IPI65R099C6

Revision: 2011-12-14, Rev. 2.0

Previous Revision

Revision	Date	Subjects (major changes since last revision)
1.0	2011-12-14	Release of final datasheet
2.0	2011-12-14	Release of final datasheet

We Listen to Your Comments

Any information within this document that you feel is wrong, unclear or missing at all? Your feedback will help us to continuously improve the quality of this document. Please send your proposal (including a reference to this document) to: erratum@infineon.com

Edition 2011-08-01

Published by

Infineon Technologies AG

81726 München, Germany

© 2011 Infineon Technologies AG

All Rights Reserved.

Legal Disclaimer

The information given in this document shall in no event be regarded as a guarantee of conditions or characteristics. With respect to any examples or hints given herein, any typical values stated herein and/or any information regarding the application of the device, Infineon Technologies hereby disclaims any and all warranties and liabilities of any kind, including without limitation, warranties of non-infringement of intellectual property rights of any third party.

Information

For further information on technology, delivery terms and conditions and prices please contact your nearest Infineon Technologies Office (www.infineon.com).

Warnings

Due to technical requirements, components may contain dangerous substances. For information on the types in question, please contact the nearest Infineon Technologies Office.

The Infineon Technologies component described in this Data Sheet may be used in life-support devices or systems and/or automotive, aviation and aerospace applications or systems only with the express written approval of Infineon Technologies, if a failure of such components can reasonably be expected to cause the failure of that life-support, automotive, aviation and aerospace device or system or to affect the safety or effectiveness of that device or system. Life support devices or systems are intended to be implanted in the human body or to support and/or maintain and sustain and/or protect human life. If they fail, it is reasonable to assume that the health of the user or other persons may be endangered.