

Features

- $BV_{CEO} > 300V$
- $I_C = 500mA$ high Collector Current
- 2W Power Dissipation
- Low Saturation Voltage $V_{CE(sat)} < 500mV @ 20mA$
- Complementary PNP Type: DZTA92
- **Totally Lead-Free & Fully RoHS Compliant (Notes 1 & 2)**
- **Halogen and Antimony Free. "Green" Device (Note 3)**
- **Qualified to AEC-Q101 Standards for High Reliability**
- **An Automotive-Compliant Part is Available Under Separate Datasheet ([DZTA42Q](#))**

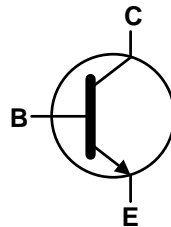

Top View



Device Symbol

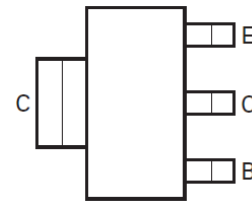

Top View
Pin-Out

Mechanical Data

- Case: SOT223
- Case Material: Molded Plastic. "Green" Molding Compound. UL Flammability Rating 94V-0
- Moisture Sensitivity: Level 1 per J-STD-020
- Terminals: Finish - Matte Tin Plated Leads, Solderable per MIL-STD-202, Method 208 @3
- Weight: 0.112 grams (Approximate)

Applications

- Switch-Mode Power Supplies (SMPS)
- Video Output Stages
- Motor Driver

Ordering Information (Note 4)

Product	Compliance	Marking	Reel Size (inches)	Tape width (mm)	Quantity per reel
DZTA42-13	AEC-Q101	K3M	13	12	2,500

- Notes:
1. No purposely added lead. Fully EU Directive 2002/95/EC (RoHS) & 2011/65/EU (RoHS 2) compliant.
 2. See http://www.diodes.com/quality/lead_free.html for more information about Diodes Incorporated's definitions of Halogen- and Antimony-free, "Green" and Lead-free.
 3. Halogen- and Antimony-free "Green" products are defined as those which contain <900ppm bromine, <900ppm chlorine (<1500ppm total Br + Cl) and <1000ppm antimony compounds.
 4. For packaging details, go to our website at <http://www.diodes.com/products/packages.html>.

Marking Information

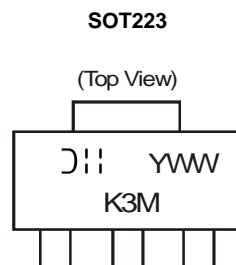

K3M = Product Type Marking Code
 YWW = Date Code Marking
 Y = Last Digit of Year ex: 6 = 2016
 WW = Week code 01 - 52

Absolute Maximum Ratings (@T_A = +25°C, unless otherwise specified.)

Characteristic	Symbol	Value	Unit
Collector-Base Voltage	V _{CBO}	300	V
Collector-Emitter Voltage	V _{CEO}	300	V
Emitter-Base Voltage	V _{EBO}	6	V
Collector Current	I _C	500	mA
Base Current	I _B	100	mA

Thermal Characteristics (@T_A = +25°C, unless otherwise specified.)

Characteristic	Symbol	Value	Unit
Power Dissipation	P _D	2	W
		1	
Thermal Resistance, Junction to Ambient	R _{θJA}	62	°C/W
		125	
Thermal Resistance, Junction to Leads	R _{θJL}	19.4	°C/W
Operating and Storage Temperature Range	T _J , T _{STG}	-65 to +150	°C

ESD Ratings (Note 8)

Characteristic	Symbol	Value	Unit	JEDEC Class
Electrostatic Discharge - Human Body Model	ESD HBM	4,000	V	3A
Electrostatic Discharge - Machine Model	ESD MM	400	V	C

- Notes:
5. For a device mounted with the collector lead on 50mm x 50mm 1oz copper that is on a single-sided 1.6mm FR4 PCB; device is measured under still air conditions whilst operating in a steady-state.
 6. Same as note (5), except mounted on minimum recommended pad (MRP) layout.
 7. Thermal resistance from junction to solder-point (at the end of the collector lead).
 8. Refer to JEDEC specification JESD22-A114 and JESD22-A115.

Thermal Characteristics and Derating Information

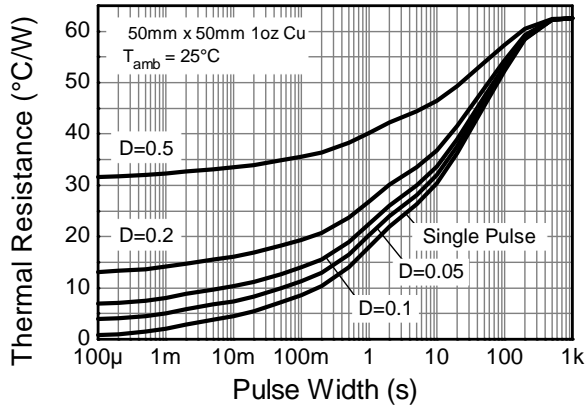

Transient Thermal Impedance

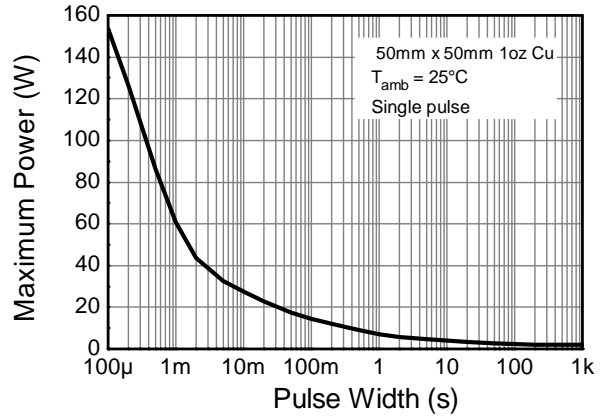

Pulse Power Dissipation

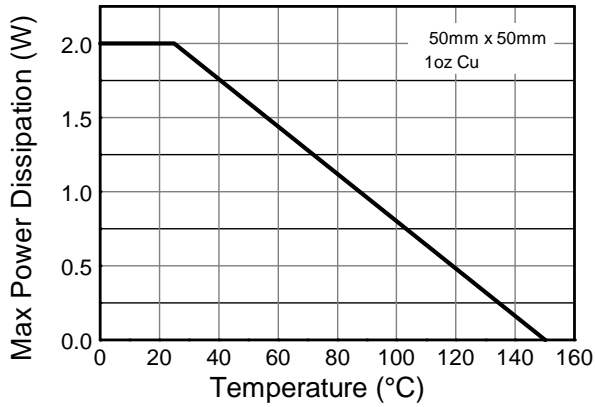

Derating Curve

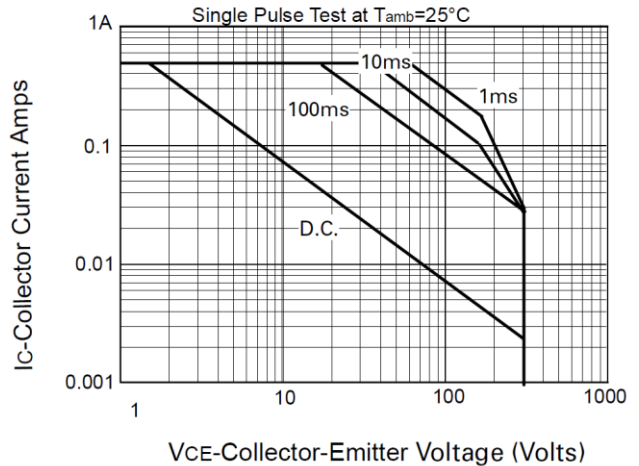

Safe operating area

Electrical Characteristics (@T_A = +25°C, unless otherwise specified.)

Characteristic	Symbol	Min	Typ	Max	Unit	Test Condition
OFF CHARACTERISTICS						
Collector-Base Breakdown Voltage	BV_{CBO}	300	—	—	V	$I_C = 100\mu A$
Collector-Emitter Breakdown Voltage (Note 9)	BV_{CEO}	300	—	—	V	$I_C = 1mA$
Emitter-Base Breakdown Voltage	BV_{EBO}	6	—	—	V	$I_E = 100\mu A$
Collector-Base Cut-off Current	I_{CBO}	—	—	0.1	μA	$V_{CB} = 200V$
Emitter-Base Cut-off Current	I_{EBO}	—	—	0.1	μA	$V_{EB} = 6V, I_C = 0$
ON CHARACTERISTICS (Note 9)						
Collector-Emitter Saturation Voltage	$V_{CE(sat)}$	—	—	0.5	V	$I_C = 20mA, I_B = 2mA$
Base-Emitter Saturation Voltage	$V_{BE(sat)}$	—	—	0.9	V	$I_C = 20mA, I_B = 2mA$
Static Forward Current Transfer Ratio	h_{FE}	25	—	—		$I_C = 1mA, V_{CE} = 10V$
		40	—	—		$I_C = 10mA, V_{CE} = 10V$
		40	—	—		$I_C = 30mA, V_{CE} = 10V$
SMALL SIGNAL CHARACTERISTICS						
Transition Frequency	f_T	50	—	—	MHz	$I_C = 10mA, V_{CE} = 20V$ $f = 100MHz$
Output Capacitance	Cobo	—	—	3	pF	$V_{CB} = 20V, f = 1MHz$

Note: 9. Measured under pulsed conditions. Pulse width $\leq 300\mu s$. Duty cycle $\leq 2\%$.

Typical Electrical Characteristics (@T_A = +25°C, unless otherwise specified.)

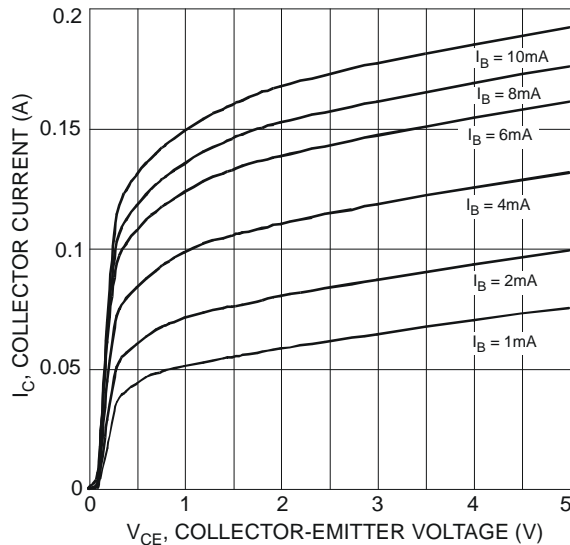

Figure 1 Typical Collector Current vs. Collector-Emitter Voltage

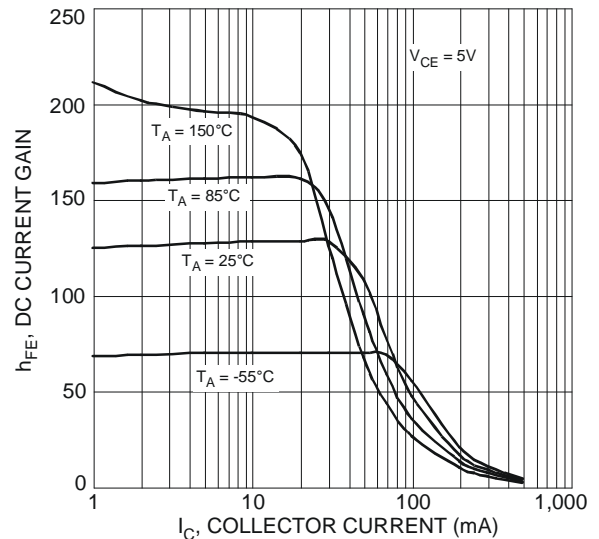

Figure 2 Typical DC Current Gain vs. Collector Current

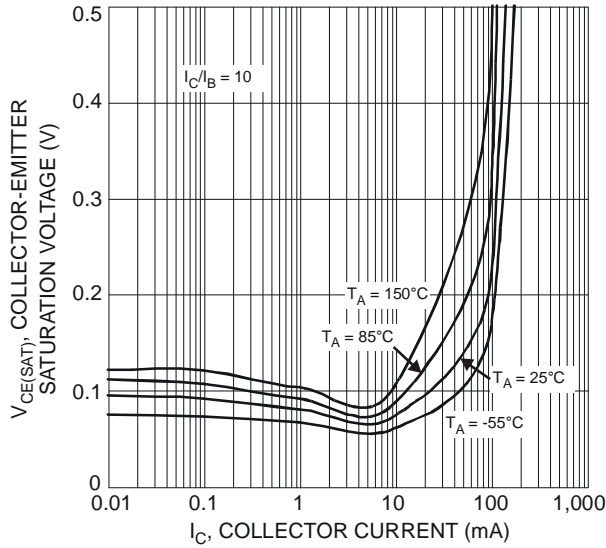

Figure 3 Typical Collector-Emitter Saturation Voltage vs. Collector Current

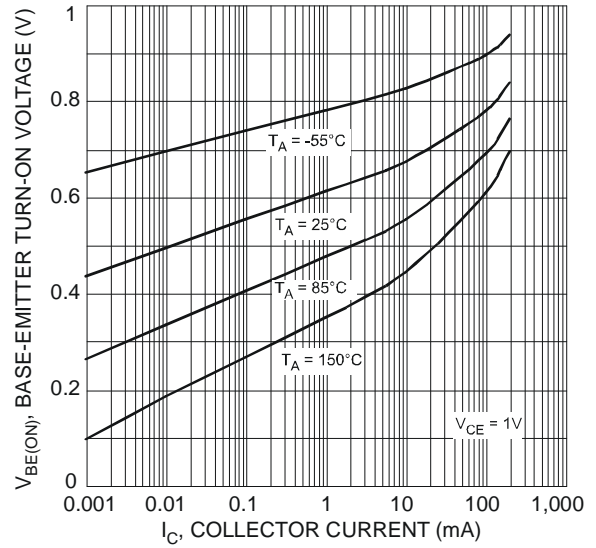

Figure 4 Typical Base-Emitter Turn-On Voltage vs. Collector Current

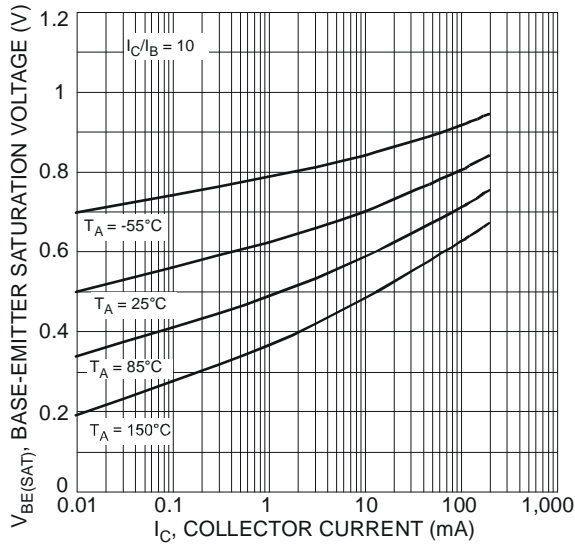

Figure 5 Typical Base-Emitter Saturation Voltage vs. Collector Current

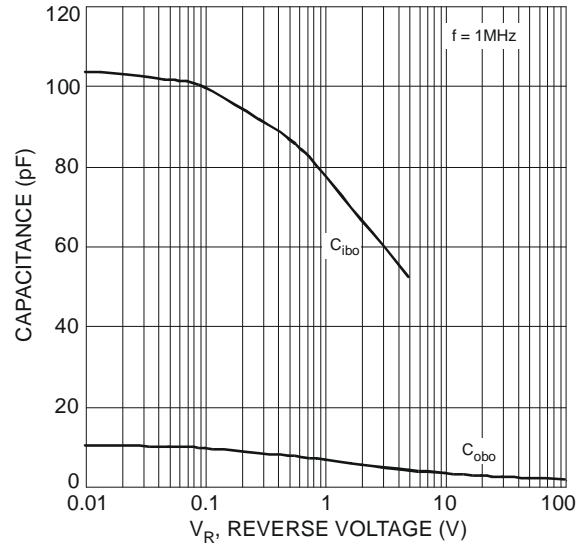

Figure 6 Typical Capacitance Characteristics

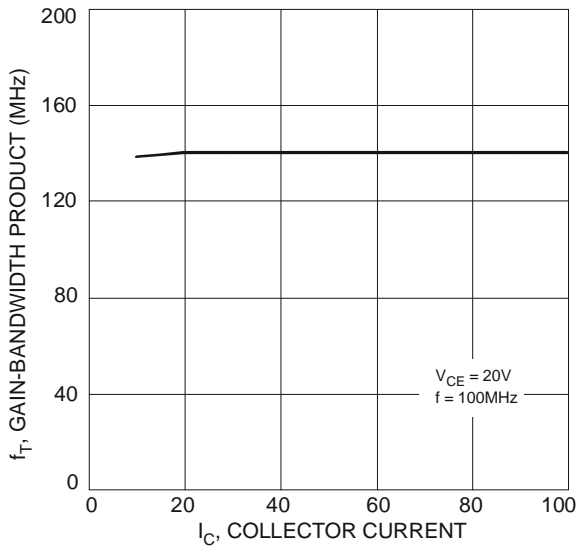
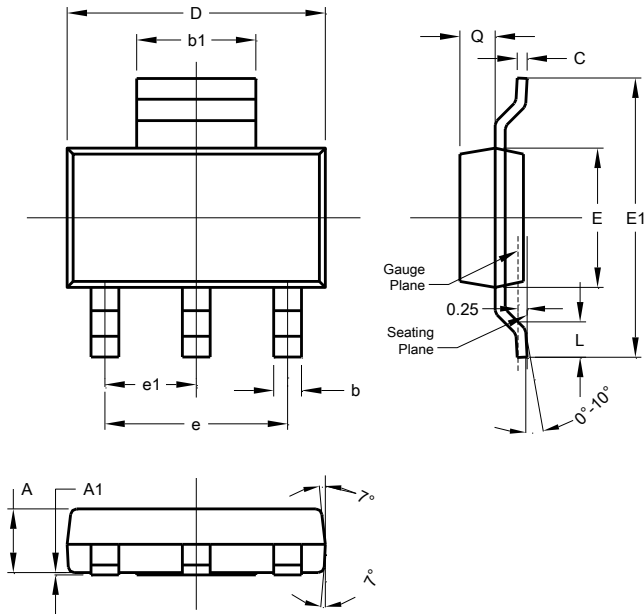

Figure 7 Typical Gain-Bandwidth Product vs. Collector Current

Package Outline Dimensions

Please see <http://www.diodes.com/package-outlines.html> for the latest version.



SOT223			
Dim	Min	Max	Typ
A	1.55	1.65	1.60
A1	0.010	0.15	0.05
b	0.60	0.80	0.70
b1	2.90	3.10	3.00
C	0.20	0.30	0.25
D	6.45	6.55	6.50
E	3.45	3.55	3.50
E1	6.90	7.10	7.00
e	-	-	4.60
e1	-	-	2.30
L	0.85	1.05	0.95
Q	0.84	0.94	0.89
All Dimensions in mm			

Suggested Pad Layout

Please see <http://www.diodes.com/package-outlines.html> for the latest version.

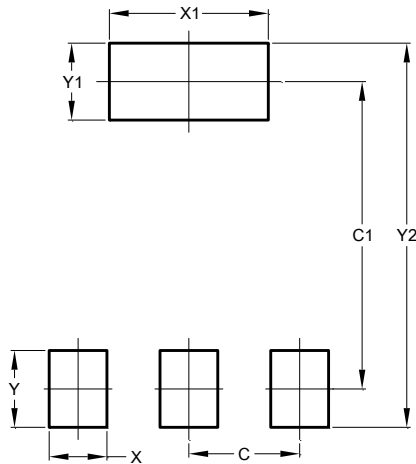

Dimensions	Value (in mm)
C	2.30
C1	6.40
X	1.20
X1	3.30
Y	1.60
Y1	1.60
Y2	8.00

Note: For high voltage applications, the appropriate industry sector guidelines should be considered with regards to creepage and clearance distances between device terminals and PCB tracking.

IMPORTANT NOTICE

DIODES INCORPORATED MAKES NO WARRANTY OF ANY KIND, EXPRESS OR IMPLIED, WITH REGARDS TO THIS DOCUMENT, INCLUDING, BUT NOT LIMITED TO, THE IMPLIED WARRANTIES OF MERCHANTABILITY AND FITNESS FOR A PARTICULAR PURPOSE (AND THEIR EQUIVALENTS UNDER THE LAWS OF ANY JURISDICTION).

Diodes Incorporated and its subsidiaries reserve the right to make modifications, enhancements, improvements, corrections or other changes without further notice to this document and any product described herein. Diodes Incorporated does not assume any liability arising out of the application or use of this document or any product described herein; neither does Diodes Incorporated convey any license under its patent or trademark rights, nor the rights of others. Any Customer or user of this document or products described herein in such applications shall assume all risks of such use and will agree to hold Diodes Incorporated and all the companies whose products are represented on Diodes Incorporated website, harmless against all damages.

Diodes Incorporated does not warrant or accept any liability whatsoever in respect of any products purchased through unauthorized sales channel. Should Customers purchase or use Diodes Incorporated products for any unintended or unauthorized application, Customers shall indemnify and hold Diodes Incorporated and its representatives harmless against all claims, damages, expenses, and attorney fees arising out of, directly or indirectly, any claim of personal injury or death associated with such unintended or unauthorized application.

Products described herein may be covered by one or more United States, international or foreign patents pending. Product names and markings noted herein may also be covered by one or more United States, international or foreign trademarks.

This document is written in English but may be translated into multiple languages for reference. Only the English version of this document is the final and determinative format released by Diodes Incorporated.

LIFE SUPPORT

Diodes Incorporated products are specifically not authorized for use as critical components in life support devices or systems without the express written approval of the Chief Executive Officer of Diodes Incorporated. As used herein:

A. Life support devices or systems are devices or systems which:

1. are intended to implant into the body, or
2. support or sustain life and whose failure to perform when properly used in accordance with instructions for use provided in the labeling can be reasonably expected to result in significant injury to the user.

B. A critical component is any component in a life support device or system whose failure to perform can be reasonably expected to cause the failure of the life support device or to affect its safety or effectiveness.

Customers represent that they have all necessary expertise in the safety and regulatory ramifications of their life support devices or systems, and acknowledge and agree that they are solely responsible for all legal, regulatory and safety-related requirements concerning their products and any use of Diodes Incorporated products in such safety-critical, life support devices or systems, notwithstanding any devices- or systems-related information or support that may be provided by Diodes Incorporated. Further, Customers must fully indemnify Diodes Incorporated and its representatives against any damages arising out of the use of Diodes Incorporated products in such safety-critical, life support devices or systems.

Copyright © 2016, Diodes Incorporated

www.diodes.com