

High Efficiency Thyristor

$$V_{RRM} = 1200 \text{ V}$$

$$I_{TAV} = 30 \text{ A}$$

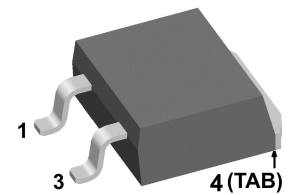
$$V_T = 1.27 \text{ V}$$

Two Quadrants Operation QI & QII
 Single Thyristor with two gate polarities

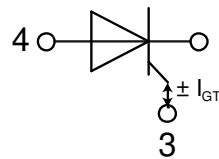
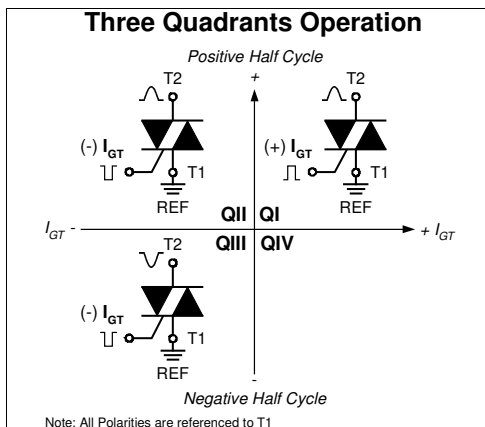
Part number

CLA30E1200NPZ

Marking on Product: CLA30E1200NPZ



Backside: anode



Features / Advantages:

- Thyristor for line frequency
- Planar passivated chip
- Long-term stability
- Two gate current polarities usable
 - positive -> quadrant I
 - negative -> quadrant II
- Thyristor can be used as Triac
 - anti-parallel combination with AGT
 - Anode-Gated-Thyristor covers quadrant III
 - AGT-counterpart: CLB30I1200PZ

Applications:

- Line rectifying 50/60 Hz
- Softstart AC motor control
- DC Motor control
- Power converter
- AC power control
- Lighting and temperature control

Package: TO-263 (D2Pak-HV)

- Industry standard outline
- RoHS compliant
- Epoxy meets UL 94V-0

Disclaimer Notice

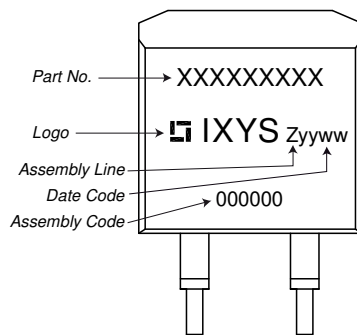
Information furnished is believed to be accurate and reliable. However, users should independently evaluate the suitability of and test each product selected for their own applications. Littelfuse products are not designed for, and may not be used in, all applications. Read complete Disclaimer Notice at www.littelfuse.com/disclaimer-electronics.

Thyristor			Ratings			
Symbol	Definition	Conditions	min.	typ.	max.	Unit
$V_{RSM/DSM}$	max. non-repetitive reverse/forward blocking voltage	$T_{VJ} = 25^{\circ}\text{C}$			1300	V
$V_{RRM/DRM}$	max. repetitive reverse/forward blocking voltage	$T_{VJ} = 25^{\circ}\text{C}$			1200	V
I_{RD}	reverse current, drain current	$V_{R/D} = 1200\text{ V}$	$T_{VJ} = 25^{\circ}\text{C}$		10	μA
		$V_{R/D} = 1200\text{ V}$	$T_{VJ} = 125^{\circ}\text{C}$		2	mA
V_T	forward voltage drop	$I_T = 30\text{ A}$	$T_{VJ} = 25^{\circ}\text{C}$		1.30	V
		$I_T = 60\text{ A}$			1.59	V
		$I_T = 30\text{ A}$	$T_{VJ} = 125^{\circ}\text{C}$		1.27	V
		$I_T = 60\text{ A}$			1.65	V
I_{TAV}	average forward current	$T_C = 115^{\circ}\text{C}$	$T_{VJ} = 150^{\circ}\text{C}$		30	A
$I_{T(RMS)}$	RMS forward current	180° sine			47	A
V_{T0}	threshold voltage	} for power loss calculation only	$T_{VJ} = 150^{\circ}\text{C}$		0.86	V
r_T	slope resistance				13.2	m Ω
R_{thJC}	thermal resistance junction to case				0.5	K/W
R_{thCH}	thermal resistance case to heatsink			0.25		K/W
P_{tot}	total power dissipation		$T_C = 25^{\circ}\text{C}$		250	W
I_{TSM}	max. forward surge current	$t = 10\text{ ms}; (50\text{ Hz}), \text{ sine}$	$T_{VJ} = 45^{\circ}\text{C}$		300	A
		$t = 8,3\text{ ms}; (60\text{ Hz}), \text{ sine}$	$V_R = 0\text{ V}$		325	A
		$t = 10\text{ ms}; (50\text{ Hz}), \text{ sine}$	$T_{VJ} = 150^{\circ}\text{C}$		255	A
		$t = 8,3\text{ ms}; (60\text{ Hz}), \text{ sine}$	$V_R = 0\text{ V}$		275	A
I^2t	value for fusing	$t = 10\text{ ms}; (50\text{ Hz}), \text{ sine}$	$T_{VJ} = 45^{\circ}\text{C}$		450	A ² s
		$t = 8,3\text{ ms}; (60\text{ Hz}), \text{ sine}$	$V_R = 0\text{ V}$		440	A ² s
		$t = 10\text{ ms}; (50\text{ Hz}), \text{ sine}$	$T_{VJ} = 150^{\circ}\text{C}$		325	A ² s
		$t = 8,3\text{ ms}; (60\text{ Hz}), \text{ sine}$	$V_R = 0\text{ V}$		315	A ² s
C_J	junction capacitance	$V_R = 400\text{ V } f = 1\text{ MHz}$	$T_{VJ} = 25^{\circ}\text{C}$		13	pF
P_{GM}	max. gate power dissipation	$t_p = 30\text{ }\mu\text{s}$	$T_C = 150^{\circ}\text{C}$		10	W
		$t_p = 300\text{ }\mu\text{s}$			5	W
P_{GAV}	average gate power dissipation				0.5	W
$(di/dt)_{cr}$	critical rate of rise of current	$T_{VJ} = 150^{\circ}\text{C}; f = 50\text{ Hz}$ repetitive, $I_T = 90\text{ A}$			150	A/ μs
		$t_p = 200\text{ }\mu\text{s}; di_G/dt = 0.3\text{ A}/\mu\text{s};$ $I_G = 0.3\text{ A}; V = \frac{2}{3} V_{DRM}$ non-repet., $I_T = 30\text{ A}$			500	A/ μs
$(dv/dt)_{cr}$	critical rate of rise of voltage	$V = \frac{2}{3} V_{DRM}$	$T_{VJ} = 150^{\circ}\text{C}$		500	V/ μs
		$R_{GK} = \infty$; method 1 (linear voltage rise)				
V_{GT}	gate trigger voltage	$V_D = 6\text{ V}$	$T_{VJ} = 25^{\circ}\text{C}$		1.3	V
			$T_{VJ} = -40^{\circ}\text{C}$		1.6	V
I_{GT}	gate trigger current	$V_D = 6\text{ V}$	$T_{VJ} = 25^{\circ}\text{C}$		± 30	mA
			$T_{VJ} = -40^{\circ}\text{C}$		± 50	mA
V_{GD}	gate non-trigger voltage	$V_D = \frac{2}{3} V_{DRM}$	$T_{VJ} = 150^{\circ}\text{C}$		0.2	V
I_{GD}	gate non-trigger current				± 1	mA
I_L	latching current	$t_p = 10\text{ }\mu\text{s}$	$T_{VJ} = 25^{\circ}\text{C}$		90	mA
		$I_G = 0.3\text{ A}; di_G/dt = 0.3\text{ A}/\mu\text{s}$				
I_H	holding current	$V_D = 6\text{ V } R_{GK} = \infty$	$T_{VJ} = 25^{\circ}\text{C}$		60	mA
t_{gd}	gate controlled delay time	$V_D = \frac{1}{2} V_{DRM}$	$T_{VJ} = 25^{\circ}\text{C}$		2	μs
		$I_G = 0.3\text{ A}; di_G/dt = 0.3\text{ A}/\mu\text{s}$				
t_q	turn-off time	$V_R = 100\text{ V}; I_T = 30\text{ A}; V = \frac{2}{3} V_{DRM}$ $di/dt = 10\text{ A}/\mu\text{s } dv/dt = 20\text{ V}/\mu\text{s } t_p = 200\text{ }\mu\text{s}$	$T_{VJ} = 125^{\circ}\text{C}$		150	μs



Package TO-263 (D2Pak-HV)		Ratings				
Symbol	Definition	Conditions	min.	typ.	max.	Unit
I_{RMS}	RMS current	per terminal			35	A
T_{VJ}	virtual junction temperature		-40		150	°C
T_{op}	operation temperature		-40		125	°C
T_{stg}	storage temperature		-40		150	°C
Weight				1.5		g
F_C	mounting force with clip		20		60	N
$d_{Spp/App}$	creepage distance on surface / striking distance through air	terminal to terminal	4.2			mm
$d_{Spb/Apb}$		terminal to backside	4.7			mm

Product Marking



Part description

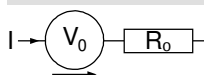
- C = Thyristor (SCR)
- L = High Efficiency Thyristor
- A = (up to 1200V)
- 30 = Current Rating [A]
- E = Single Thyristor with two gate polarities
- 1200 = Reverse Voltage [V]
- N = Three Quadrants operation: QI - QIII
- PZ = TO-263AB (D2Pak) (2HV)

Ordering	Ordering Number	Marking on Product	Delivery Mode	Quantity	Code No.
Standard	CLA30E1200NPZ-TRL	CLA30E1200NPZ	Tape & Reel	800	516330
Alternative	CLA30E1200NPZ-TUB	CLA30E1200NPZ	Tube	50	525248

Equivalent Circuits for Simulation

* on die level

$T_{VJ} = 150\text{ °C}$

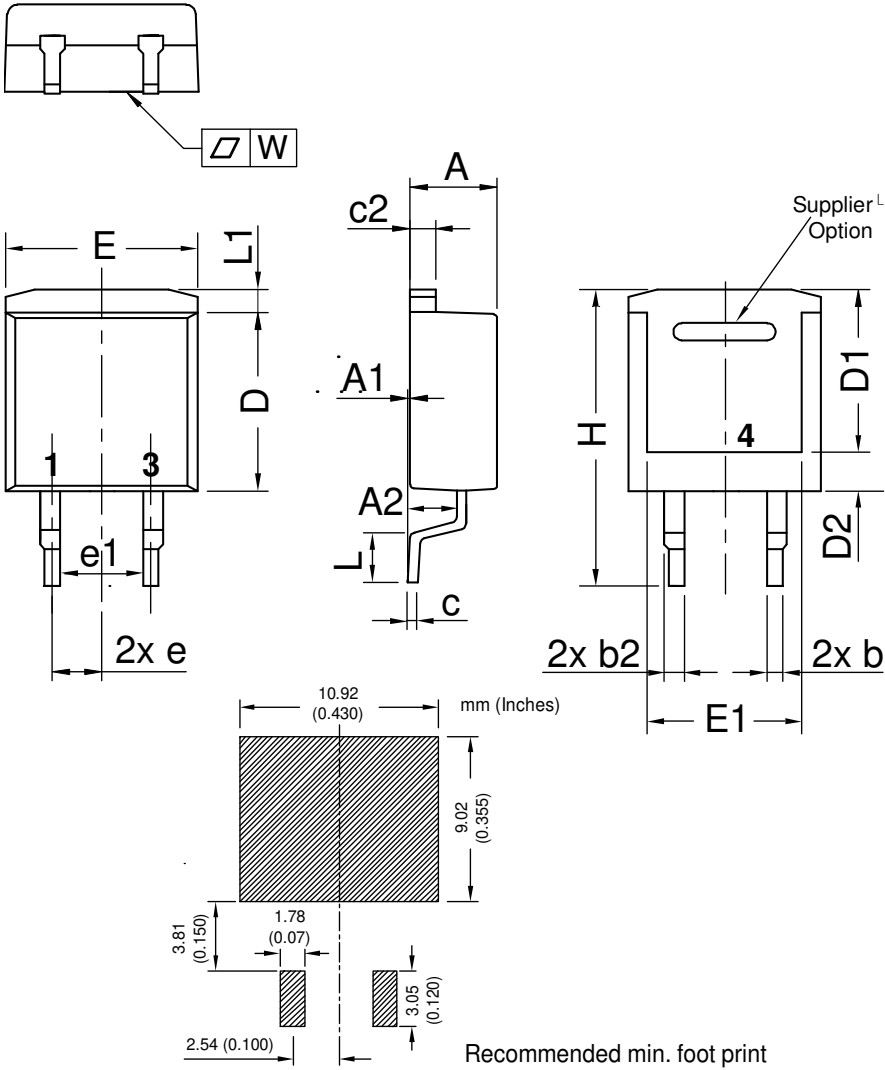


Thyristor

$V_{0\ max}$	threshold voltage	0.86	V
$R_{0\ max}$	slope resistance *	10	mΩ

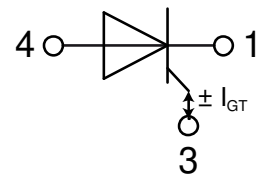


Outlines TO-263 (D2Pak-HV)



Dim.	Millimeter		Inches	
	min	max	min	max
A	4.06	4.83	0.160	0.190
A1	typ. 0.10		typ. 0.004	
A2	2.41		0.095	
b	0.51	0.99	0.020	0.039
b2	1.14	1.40	0.045	0.055
c	0.40	0.74	0.016	0.029
c2	1.14	1.40	0.045	0.055
D	8.38	9.40	0.330	0.370
D1	8.00	8.89	0.315	0.350
D2	2.3		0.091	
E	9.65	10.41	0.380	0.410
E1	6.22	8.50	0.245	0.335
e	2,54 BSC		0,100 BSC	
e1	4.28		0.169	
H	14.61	15.88	0.575	0.625
L	1.78	2.79	0.070	0.110
L1	1.02	1.68	0.040	0.066
W	typ. 0.02	0.040	typ. 0.0008	0.002

All dimensions conform with and/or within JEDEC standard.



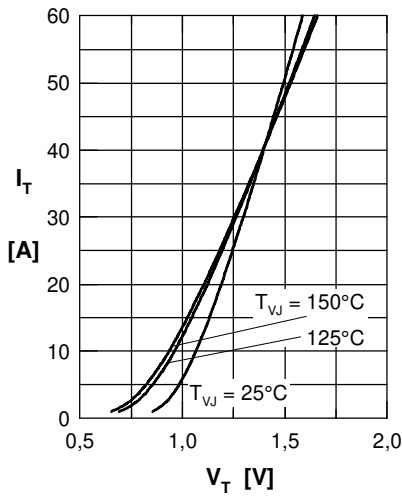
Thyristor


Fig. 1 Forward characteristics

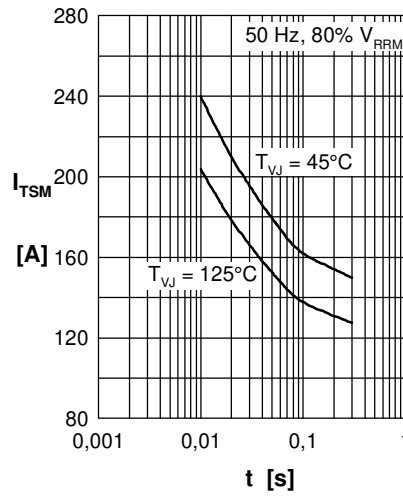
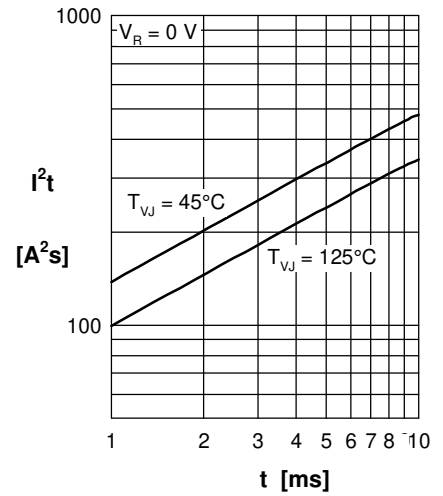
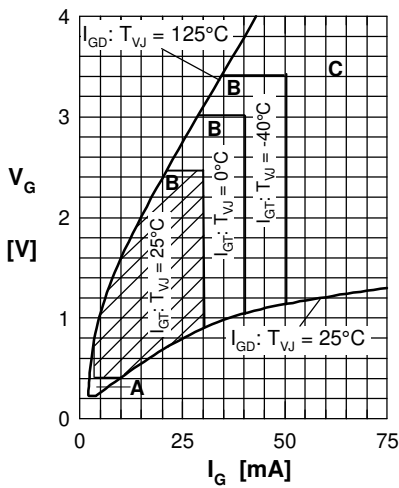
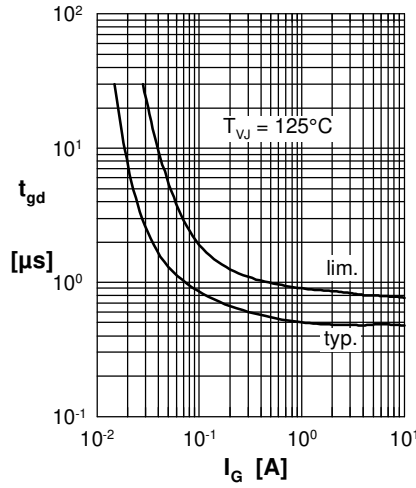
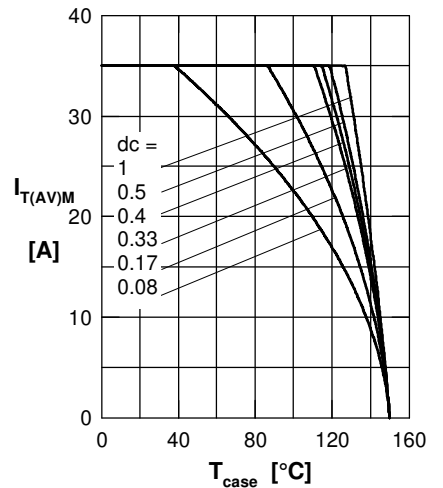

 Fig. 2 Surge overload current
 I_{TSM} : crest value, t : duration

 Fig. 3 I^2t versus time (1-10 s)

 Fig. 4 Gate voltage & gate current
 Triggering: A = no; B = possible; C = safe

 Fig. 5 Gate controlled delay time t_{gd}


Fig. 6 Max. forward current at case temperature

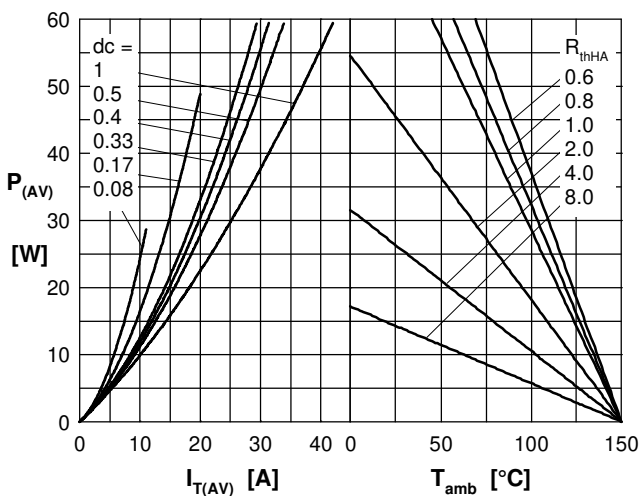
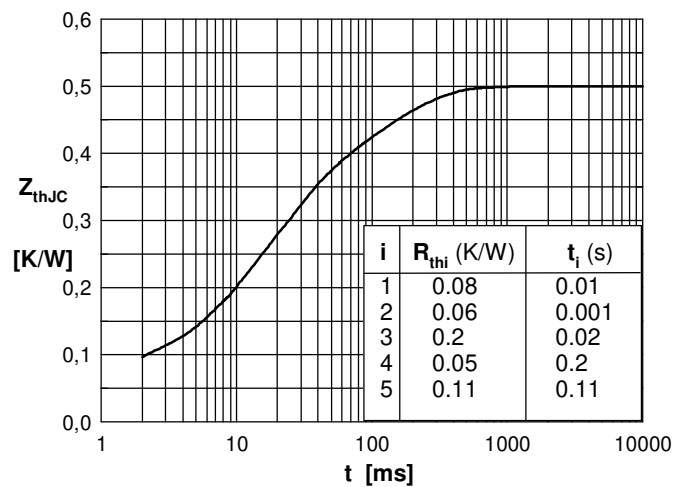

 Fig. 7a Power dissipation versus direct output current
 Fig. 7b and ambient temperature


Fig. 7 Transient thermal impedance junction to case