STLINK-V3SET debugger/programmer for STM8 and STM32

Introduction

The STLINK-V3SET is a stand-alone modular debugging and programming probe for the STM8 and STM32 microcontrollers. This product is composed of a main module and a complementary adapter board. It supports the SWIM and JTAG/SWD interfaces for the communication with any STM8 or STM32 microcontroller located on an application board.

The STLINK-V3SET provides a Virtual COM port interface allowing the host PC to communicate with the target microcontroller through one UART. It also provides bridge interfaces to several communication protocols allowing for instance the programming of the target through bootloader.

The modular architecture of STLINK-V3SET enables to extend its main features through additional modules such as the adapter board.

Figure 1. STLINK-V3SET product top view

Picture is not contractual.

Contents

- 1 Features 6**
- 2 General information 6**
- 3 System requirements 7**
- 4 Development toolchains 7**
- 5 Ordering information 7**
- 6 Conventions 7**
- 7 Quick start 8**
- 8 STLINK-V3SET functional description 9**
 - 8.1 STLINK-V3SET overview 9
 - 8.1.1 Main module for high performance 9
 - 8.1.2 Adapter configuration for added functions 10
 - 8.1.3 How to build the adapter configuration for added functions 11
 - 8.2 Hardware layout 12
 - 8.3 STLINK-V3SET functions 16
 - 8.3.1 SWD with SWV 16
 - 8.3.2 JTAG 17
 - 8.3.3 SWIM 17
 - 8.3.4 Virtual COM port (VCP) 17
 - 8.3.5 Bridge functions 17
 - 8.3.6 LEDs 18
 - 8.4 Jumper configuration 18
- 9 Board connectors 20**
 - 9.1 Connectors on MB1441 board 20
 - 9.1.1 USB Micro-B 20
 - 9.1.2 STDC14 (STM32 JTAG/SWD and VCP) 21
 - 9.2 Connectors on MB1440 board 21

9.2.1	STDC14 (STM32 JTAG/SWD and VCP)	21
9.2.2	Legacy Arm 20-pin JTAG/SWD IDC connector	21
9.2.3	Virtual COM port connector	22
9.2.4	SWIM connector	22
9.2.5	CAN connector	23
9.2.6	SWD connector	23
9.2.7	UART bridge connector	23
9.2.8	SPI bridge connector	24
9.2.9	Bridge 20-pins connector	24
10	Flat ribbons	25
11	Software configuration	26
11.1	Supporting toolchains (not exhaustive)	26
11.2	Drivers and firmware upgrade	26
11.3	STLINK-V3SET frequency selection	26
11.4	Mass storage interface	26
11.5	Bridge interface	27
12	Product STLINK-V3SET revision history and limitations	28
Appendix A	Federal Communications Commission (FCC).....	29
15.3	FCC Compliance Statement	29
15.3.1	Part 15.19	29
	Revision history	30

List of tables

Table 1.	Ordering information	7
Table 2.	ON/OFF convention	7
Table 3.	MB1441 jumper configuration	18
Table 4.	MB1440 jumper configuration	18
Table 5.	USB Micro-B connector pinout CN5	20
Table 6.	STDC14 connector pinout CN1	21
Table 7.	Legacy Arm 20-pin JTAG/SWD IDC connector CN2	22
Table 8.	Virtual COM port connector CN3	22
Table 9.	SWIM connector CN4	22
Table 10.	CAN connector CN5	23
Table 11.	SWD (wires) connector CN6	23
Table 12.	UART bridge connector CN7	23
Table 13.	SPI bridge connector CN8	24
Table 14.	Bridge connector CN9	24
Table 15.	ARM10-compatible connector pinout (target side)	25
Table 16.	ARM20-compatible connector pinout (target side)	25
Table 17.	Toolchain versions supporting STLINK-V3SET	26
Table 18.	Product STLINK-V3SET revision history and limitations	28
Table 19.	Document revision history	30

List of figures

Figure 1.	STLINK-V3SET product top view	1
Figure 2.	Probe top side.	9
Figure 3.	Connections	10
Figure 4.	Probe with adapter	10
Figure 5.	Operating mode to change the configuration	11
Figure 6.	Hardware board MB1441	12
Figure 7.	Hardware board MB1440	13
Figure 8.	MB1441 top layout	14
Figure 9.	MB1441 bottom layout	14
Figure 10.	MB1440 top layout	15
Figure 11.	MB1441 mechanical drawing	15
Figure 12.	MB1441 mechanical drawing	16
Figure 13.	USB Micro-B connector CN5 (front view)	20

1 Features

- Stand-alone probe with modular extensions
- Self-powered through a USB connector (Micro-B)
- USB 2.0 high-speed compatible interface
- Direct firmware update support (DFU)
- JTAG / serial wire debugging (SWD) specific features:
 - 3 V to 3.6 V application voltage support and 5 V tolerant inputs
 - Flat cables STDC14 to MIPI10 / STDC14 / MIPI20 (connectors with 1.27 mm pitch)
 - JTAG communication support
 - SWD and serial wire viewer (SWV) communication support
- SWIM specific features (only available with adapter board MB1440):
 - 1.65 V to 5.5 V application voltage support
 - SWIM header (2.54 mm pitch)
 - SWIM low-speed and high-speed modes support
- Virtual COM port (VCP) specific features:
 - 3 V to 3.6 V application voltage support on the UART interface and 5 V tolerant inputs
 - VCP frequency up to 15 MHz
 - Available on STDC14 debug connector (not available on MIPI10)
- Multi-path bridge USB to SPI/UART/I²C/CAN/GPIOs specific features:
 - 3 V to 3.6 V application voltage support and 5 V tolerant inputs
 - Signals available on adapter board only (MB1440)
- Drag-and-drop Flash programming
- Two color LEDs: communication, power

Note: The STLINK-V3SET product does not provide power supply to the target application.

2 General information

The STLINK-V3SET embeds an STM32 32-bit microcontroller based on the Arm^{®(a)} Cortex[®]-M processor.



a. Arm is a registered trademark of Arm Limited (or its subsidiaries) in the US and or elsewhere.

3 System requirements

- Windows® OS (7, 8 and 10), Linux® 64-bit, or macOS®(a)
- USB Type-A to Micro-B cable

4 Development toolchains

- Keil® MDK-ARM(b)
- IAR™ EWARM(b)
- GCC-based IDEs

5 Ordering information

To order the STLINK-V3SET, refer to [Table 1](#).

Table 1. Ordering information

Order code	Description
STLINK-V3SET	STLINK-V3 modular in-circuit debugger and programmer for STM8 and STM32.

6 Conventions

[Table 2](#) provides the conventions used for the ON and OFF settings in the present document.

Table 2. ON/OFF convention

Convention	Definition
Jumper JPx ON	Jumper fitted
Jumper JPx OFF	Jumper not fitted
Jumper JPx [1-2]	Jumper should be fitted between Pin 1 and Pin 2
Solder bridge SBx ON	SBx connections closed by 0 ohm resistor
Solder bridge SBx OFF	SBx connections left open

a. macOS® is a trademark of Apple Inc. registered in the U.S. and other countries.

b. On Windows® only.

7 Quick start

This section describes how to start a development quickly using the STLINK-V3SET.

Before installing and using the product, accept the Evaluation Product License Agreement from the www.st.com/epla web page.

The STLINK-V3SET is a stand-alone modular debugging and programming probe for STM8 and STM32 microcontrollers.

- It support protocols SWIM, JTAG and SWD to communicate with any STM8 or STM32 microcontroller.
- It provides a Virtual COM port interface allowing the host PC to communicate with the target microcontroller through one UART
- It provides bridge interfaces to several communication protocols allowing for instance the programming of the target through bootloader.

To start using this board, follow the steps below:

1. Check that all items are available inside the box (V3S + 3 flat cables + adapter board and its guide).
2. Install/update the IDE/STM32CubeProgrammer to support the STLINK-V3SET (drivers).
3. Choose a flat cable and connect it between the STLINK-V3SET and the application.
4. Connect a USB Type-A to Micro-B cable between the STLINK-V3SET and the PC.
5. Check that the PWR LED is green and the COM LED is red.
6. Open the development toolchain or STM32CubeProgrammer software utility.

For more details, refer to the www.st.com/stlink-v3set web site.

8 STLINK-V3SET functional description

8.1 STLINK-V3SET overview

The STLINK-V3SET is a stand-alone modular debugging and programming probe for the STM8 and STM32 microcontrollers. This product supports many functions and protocols for debugging, programming or communicating with one or several targets. The STLINK-V3SET package includes complete hardware with a main module for high performance and an adapter board for added functions to connect with wires or flat cables anywhere into the application.

This module is fully powered by the PC. If the COM LED blinks red, refer to the *Overview of ST-LINK derivatives* technical note (TN1235) for details.

8.1.1 Main module for high performance

This configuration is the preferred one for high performance. It only supports STM32 microcontrollers. The working voltage range is from 3 V to 3.6 V.

Figure 2. Probe top side



The protocols and functions supported are:

- SWD with SWO (up to 24 MHz)
- JTAG (up to 21 MHz)
- VCP (from 720 bps to 15 Mbps)

A 2x7-pin male connector with 1.27 mm pitch is located in the STLINK-V3SET for connection to the application target. Three different flat cables are included in the packaging

to connect with standard connectors MIPI10/ARM10, STDC14 and ARM20 (refer to [Chapter 10: Flat ribbons on page 25](#)).

See [Figure 3](#) for connections:

Figure 3. Connections

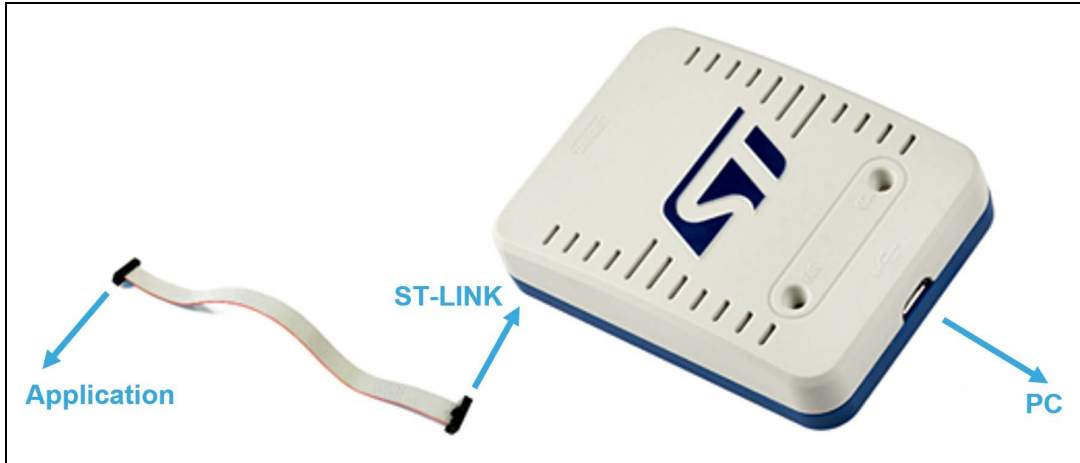

8.1.2 Adapter configuration for added functions

This configuration favors the connection to targets using wires or flat cables. It is composed of MB1441 and MB1440. It supports debugging, programming and communicating with STM32 and STM8 microcontrollers.

Figure 4. Probe with adapter

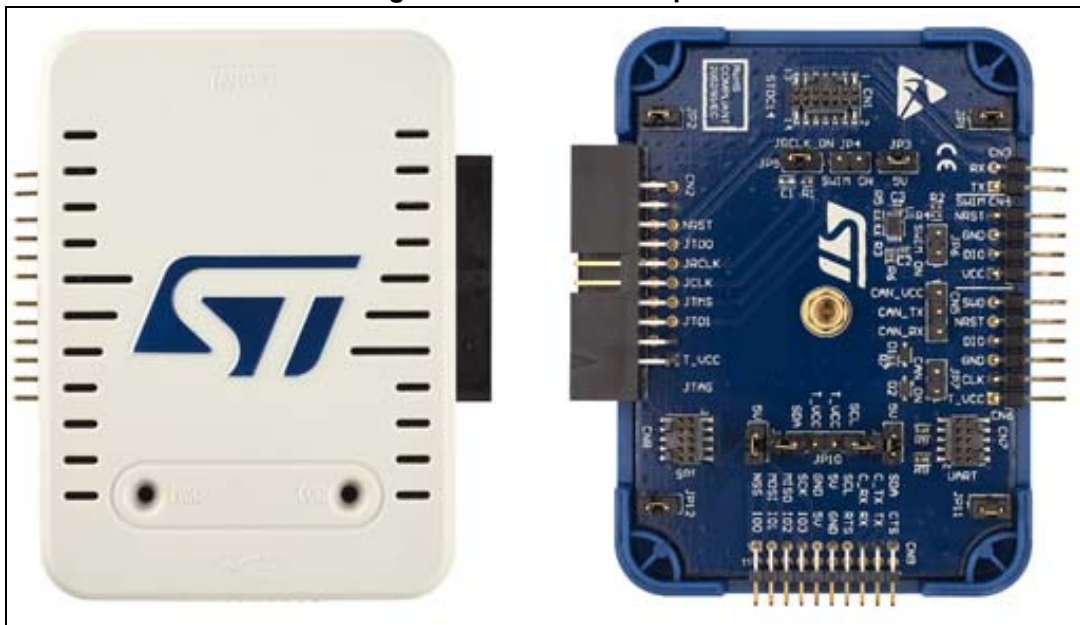

8.1.3 How to build the adapter configuration for added functions

See the operating mode below to build the adapter configuration from the main module configuration and back.

Figure 5. Operating mode to change the configuration

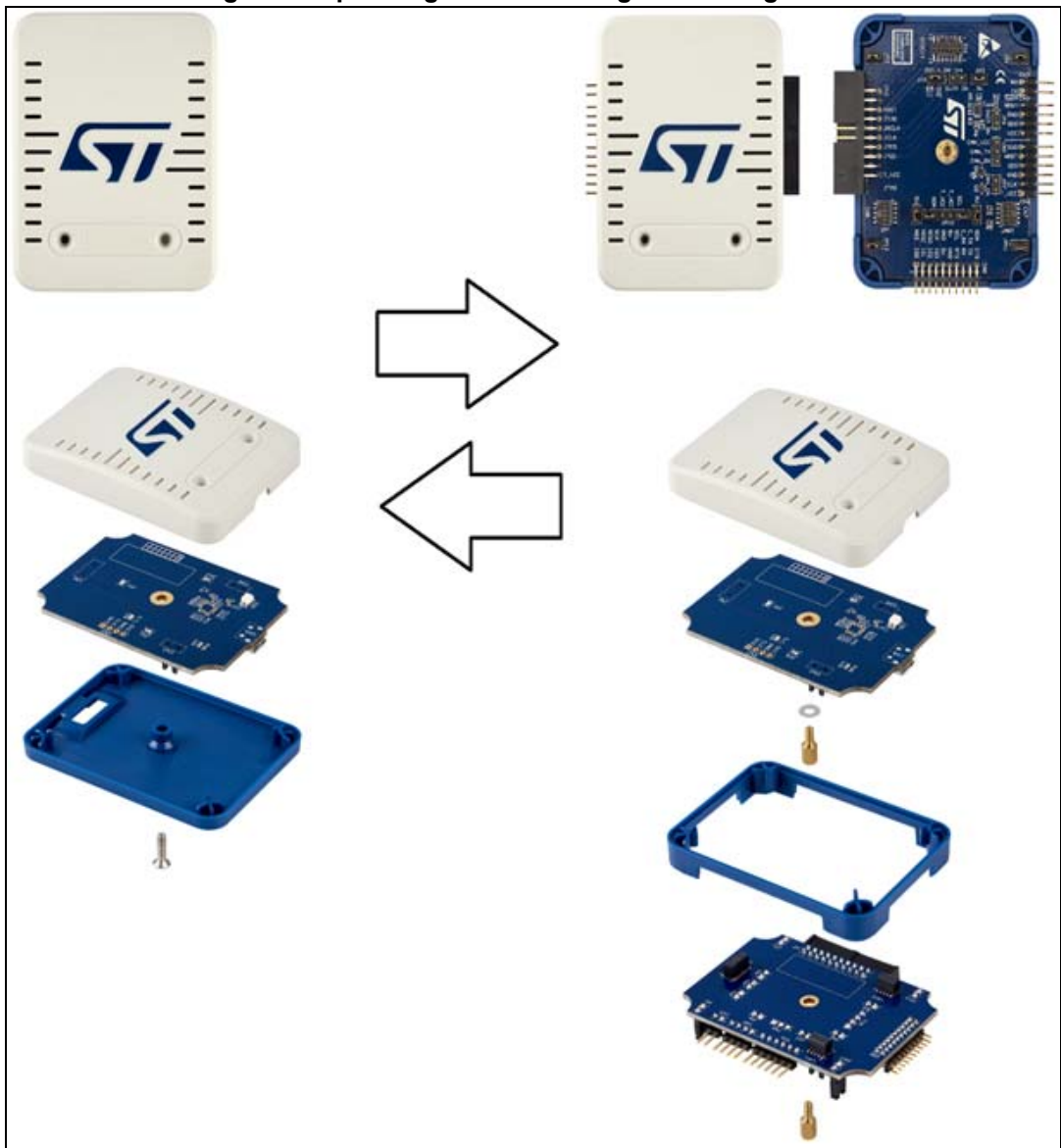

8.2 Hardware layout

The STLINK-V3SET product is designed around the STM32F723 microcontroller (176-pin in UFBGA package). The hardware board pictures ([Figure 6](#) and [Figure 7](#)) show the two boards included into the package in their standard configurations (components and jumpers). [Figure 8](#), [Figure 9](#) and [Figure 10](#) help users locate the features on the boards. The mechanical dimensions of the STLINK-V3SET product are shown in [Figure 11](#) and [Figure 12](#).

Figure 6. Hardware board MB1441

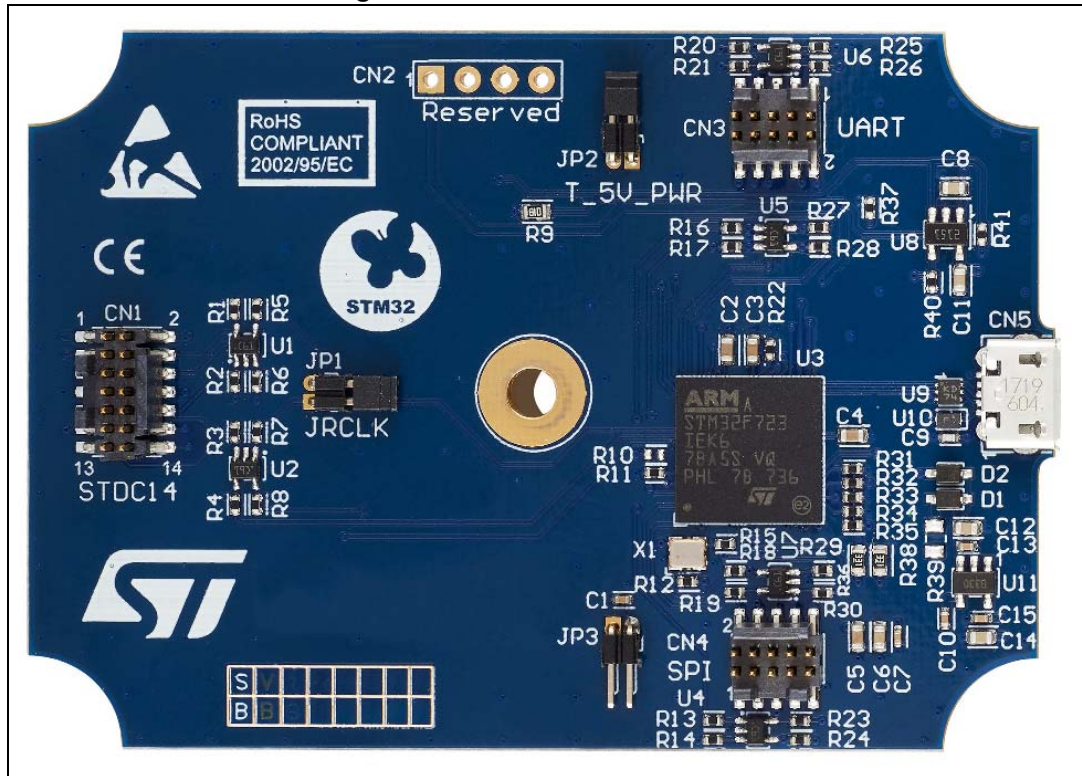

Figure 7. Hardware board MB1440

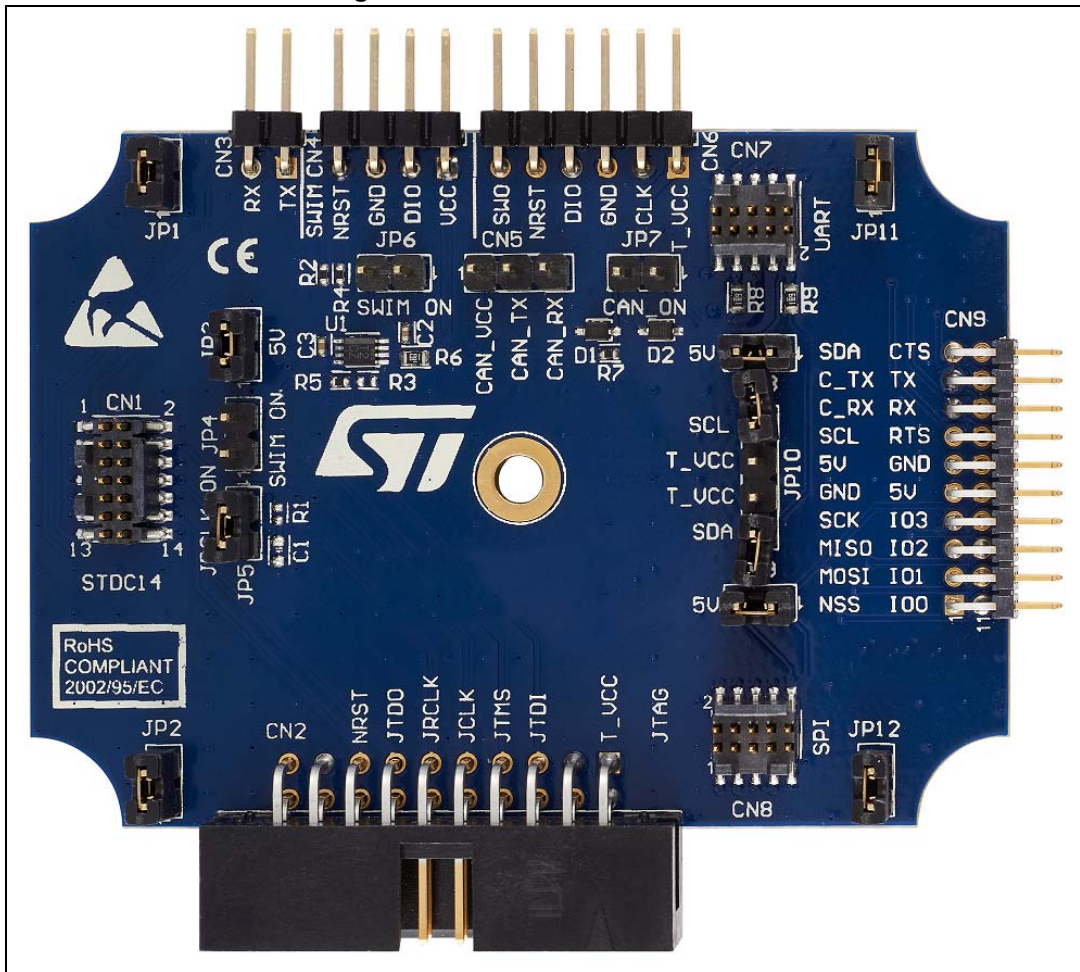

Figure 8. MB1441 top layout

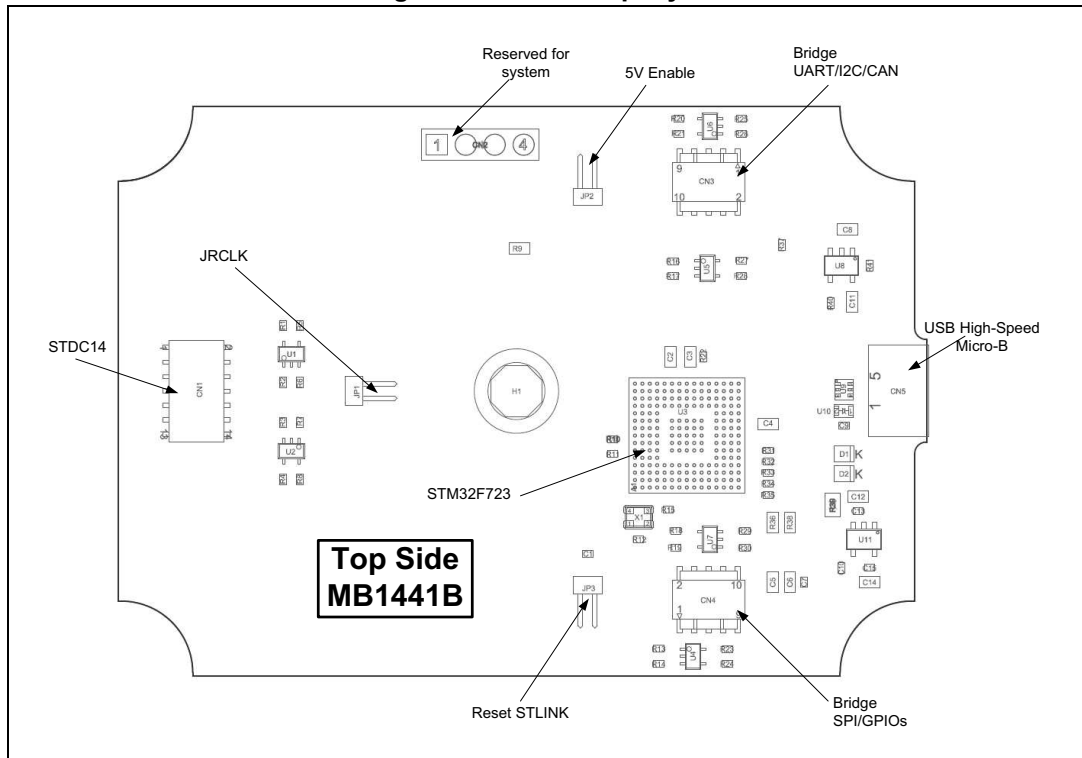

Figure 9. MB1441 bottom layout

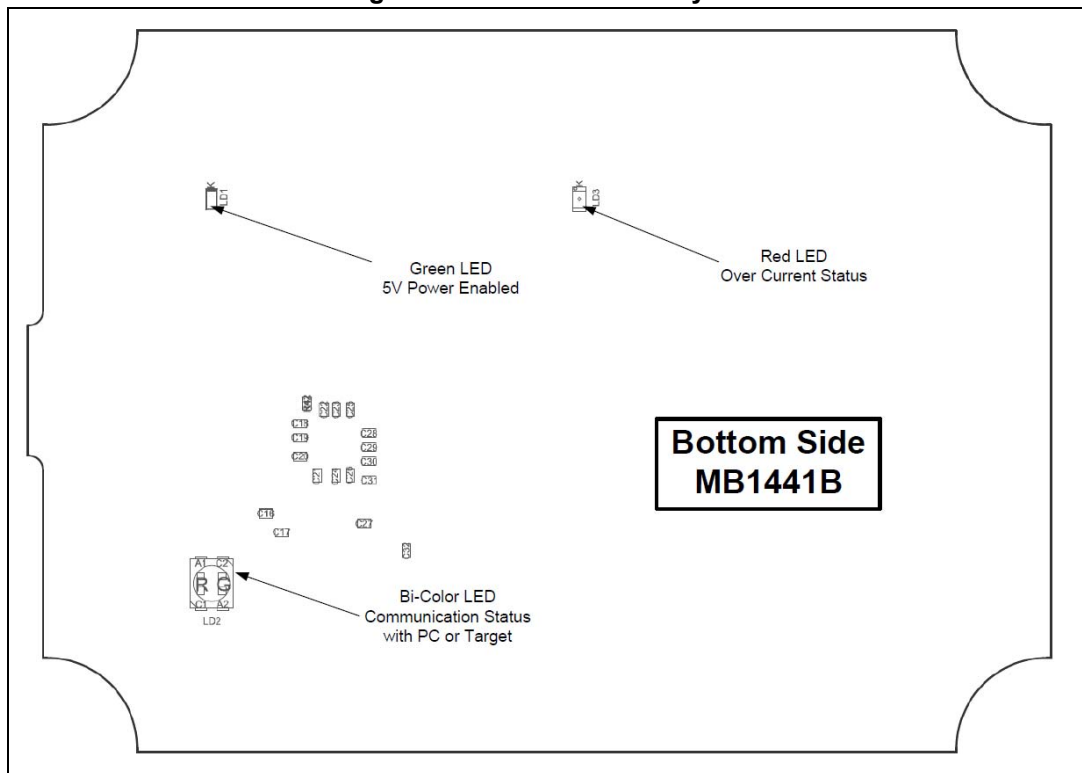

Figure 10. MB1440 top layout

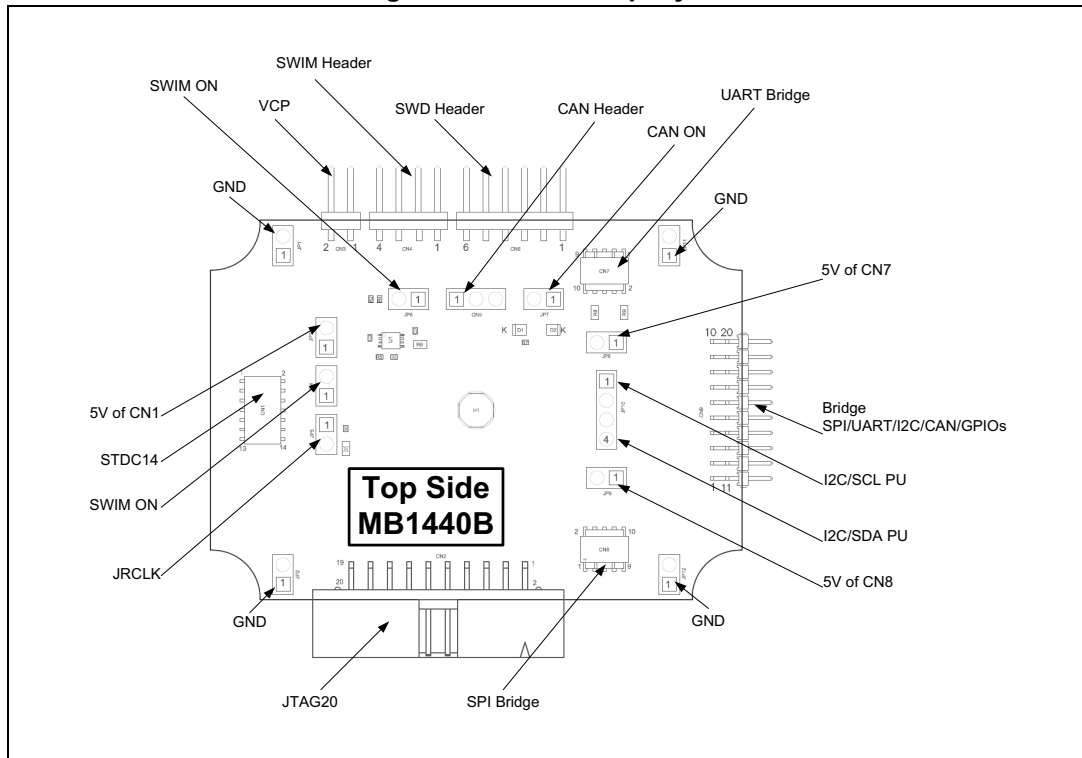

Figure 11. MB1441 mechanical drawing

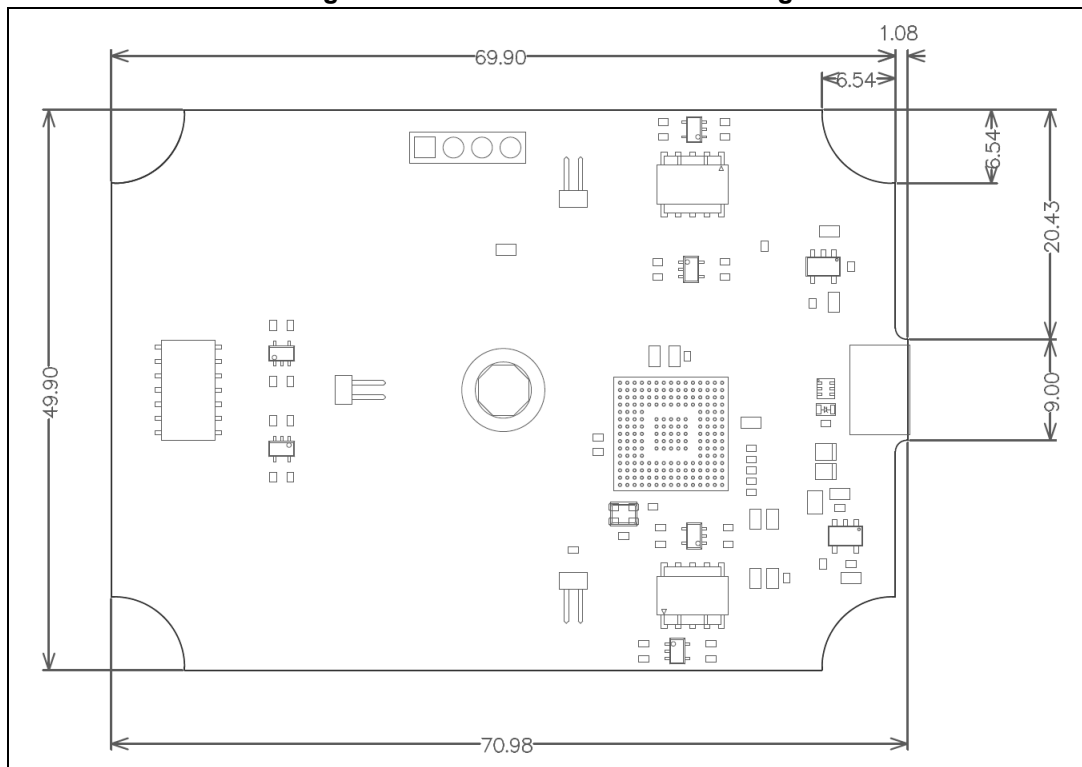
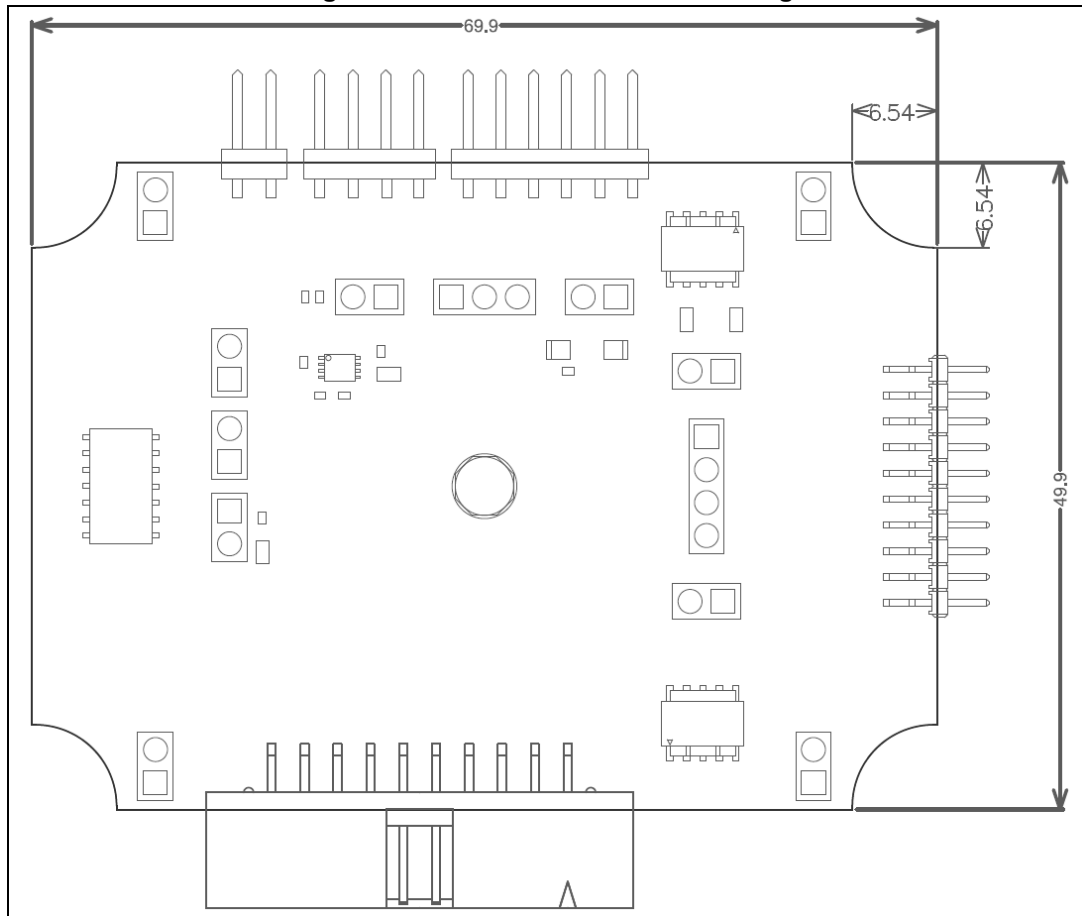

Figure 12. MB1441 mechanical drawing



8.3 STLINK-V3SET functions

All functions have been designed for high performance: all signals are 3.3-volt compatible except the SWIM protocol, which supports a voltage range from 1.65 V to 5.5 V. The following description concerns the two boards MB1441 and MB1440 and indicates where to find the functions on the boards and connectors. The main module for high performance only includes the MB1441 board. The adapter configuration for added functions includes both the MB1441 and MB1440 boards.

8.3.1 SWD with SWV

SWD protocol is a Debug/Program protocol used for STM32 microcontrollers with SWV as a trace. The signals are 3.3-volt compatible and can perform up to 24 MHz. This function is available on MB1441.CN1 and MB1440.CN1.CN2.CN6

8.3.2 JTAG

JTAG protocol is a Debug/Program protocol used for STM32 microcontrollers. The signals are 3.3-volt compatible and can perform up to 21 MHz. This function is available on MB1441.CN1 and MB1440.CN1.CN2.

8.3.3 SWIM

SWIM protocol is a Debug/Program protocol used for STM8 microcontrollers. JP4 and JP6 on the MB1440 board must be ON in order to activate the SWIM protocol. The signals are available on the MB1440.CN4 connector and a voltage range from 1.65 V to 5.5 V is supported.

8.3.4 Virtual COM port (VCP)

The serial interface VCP is directly available as a Virtual COM port of the PC, connected to STLINK-V3SET USB connector CN5. This function can be used for STM32 and STM8 microcontrollers. The signals are 3.3-volt compatible and can perform from 720 bps to 15 Mbps. This function is available on MB1441.CN1 and MB1440.CN1.CN3.

8.3.5 Bridge functions

The STLINK-V3SET provides a proprietary USB interface allowing the communication with an STM8 or STM32 target with several protocols: SPI, I²C, CAN, UART and GPIOs. This interface may be used to communicate with the target bootloader, but may also be used for customized needs through its public software interface.

All bridge signals can be accessed on CN9 in a simple and easy way by means of wire clips, with the risk that signal quality and performance are lowered, especially for SPI and UART. This depends for instance on the quality of the wires used, on the fact that the wires are shielded or not, and on the layout of the application board.

Bridge SPI

SPI signals are available on MB1440.CN9 and MB1440.CN8. In order to reach high SPI frequency, it is recommended to use a flat ribbon on MB1440.CN8 with all unused signals tied to ground on target side.

Bridge I²C

I²C signals are available on MB1440.CN9 and MB1440.CN7. The adapter module also provides optional 680-ohm pull-ups, which can be activated by closing JP10 jumpers. In that case, the target voltage (T_VCC) must be provided to any of the MB1440 connector accepting it (CN1, CN2, CN6, or JP10 jumpers).

Bridge CAN

CAN logic signals (Rx/Tx) are available on MB1440.CN9, they can be used as input for an external CAN transceiver. It is also possible to connect directly the CAN target signals to MB1440.CN5 (target Tx to CN5.Tx, target Rx to CN5.Rx), provided that:

1. JP7 (CAN ON) is closed
2. CAN voltage is provided to CN5.CAN_VCC

Bridge UART

UART signals with hardware flow control (CTS/RTS) are available on MB1440.CN9 and MB1440.CN7. They need a dedicated firmware to be programmed on the main module before being used. Without this firmware, the Virtual COM port function must be used instead (no hardware flow control).

In order to reach high UART frequency, it is recommended to use a flat ribbon on MB1440.CN7 with all unused signals tied to ground on target side.

Bridge GPIOs

Four GPIO signals are available on MB1440.CN9 and MB1440.CN8. Basic management is provided by the public ST bridge software interface.

8.3.6 LEDs

PWR LED: red light indicates that 5 V is enabled (only used when a daughter board is plugged).

COM LED: refer to the *Overview of ST-LINK derivatives* technical note (TN1235) for details.

8.4 Jumper configuration

Table 3. MB1441 jumper configuration

Jumper	State	Description
JP1	ON	JTAG clock loopback done on board
JP2	ON	Provide 5V power on connectors (internal use)
JP3	OFF	STLINK-V3SET reset. Can be used to enforce STLINK-V3SET UsbLoader mode

Table 4. MB1440 jumper configuration

Jumper	State	Description
JP1	Not used	GND
JP2	Not used	GND
JP3	ON	Get 5V power from CN12 (internal use)
JP4	OFF	Disable SWIM input
JP5	ON	JTAG clock loopback done on board
JP6	OFF	Disable SWIM output
JP7	OFF	Close in order to use CAN through CN5

Table 4. MB1440 jumper configuration (continued)

Jumper	State	Description
JP8	ON	Provide 5V power to CN7 (internal use)
JP9	ON	Provide 5V power to CN10 (internal use)
JP10	OFF	Close in order to enable I ² C pull-ups
JP11	Not used	GND
JP12	Not used	GND

9 Board connectors

11 user connectors are implemented on the STLINK-V3SET product and are described in this paragraph:

- 2 user connectors are available on the MB1441 board:
 - CN1: STDC14 (STM32 JTAG/SWD and VCP)
 - CN5: USB Micro-B (connection to the host)
- 9 user connectors are available on the MB1440 board:
 - CN1: STDC14 (STM32 JTAG/SWD and VCP)
 - CN2: Legacy Arm 20-pin JTAG/SWD IDC connector
 - CN3: VCP
 - CN4: SWIM
 - CN5: bridge CAN
 - CN6: SWD
 - CN7, CN8, CN9: bridge

Other connectors are reserved for internal use and are not described here.

9.1 Connectors on MB1441 board

9.1.1 USB Micro-B

The USB connector CN5 is used to connect the embedded STLINK-V3SET to the PC.

Figure 13. USB Micro-B connector CN5 (front view)

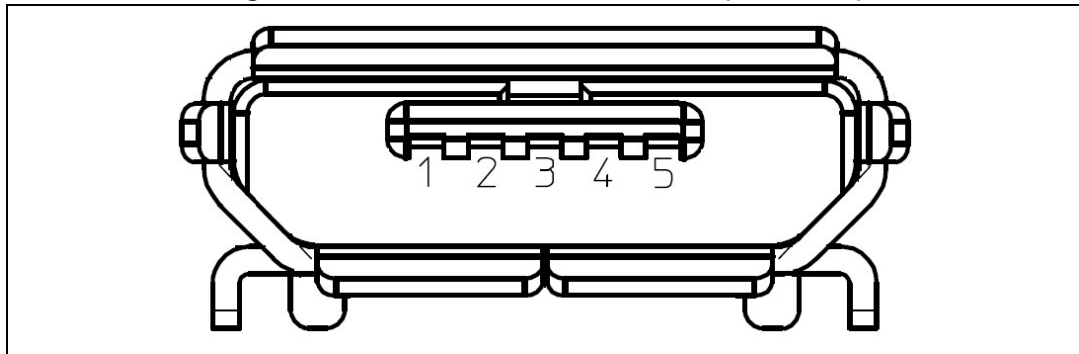

The related pinout for the USB ST-LINK connector is listed in [Table 5](#).

Table 5. USB Micro-B connector pinout CN5

Pin number	Pin name	Function
1	VBUS	5 V power
2	DM (D-)	USB differential pair M
3	DP (D+)	USB differential pair P

Table 5. USB Micro-B connector pinout CN5 (continued)

Pin number	Pin name	Function
4	ID	-
5	GND	GND

9.1.2 STDC14 (STM32 JTAG/SWD and VCP)

The STDC14 CN1 connector allows the connection to a STM32 target by means of the JTAG or SWD protocol, respecting (from pin 3 to pin 12) the ARM10 pinout (Arm Cortex Debug connector). But it also advantageously provides two UART signals for the Virtual COM port. The related pinout for the STDC14 connector is listed in [Table 6](#).

Table 6. STDC14 connector pinout CN1

Pin No.	Description	Pin No.	Description
1	Reserved ⁽¹⁾	2	Reserved ⁽¹⁾
3	T_VCC ⁽²⁾	4	T_JTMS/T_SWDIO
5	GND	6	T_JCLK/T_SWCLK
7	GND	8	T_JTDO/T_SWO ⁽³⁾
9	T_JRCLK ⁽⁴⁾ /NC ⁽⁵⁾	10	T_JTDI/NC ⁽⁵⁾
11	GNDDetect ⁽⁶⁾	12	T_NRST
13	T_VCP_RX	14	T_VCP_TX

1. Do not connect on target.
2. Input for STLINK-V3SET.
3. SWO is optional, required only for Serial Wire Viewer (SWV) trace.
4. Optional loopback of T_JCLK on target side, required if loopback removed on STLINK-V3SET side.
5. NC means not required for SWD connection.
6. Connect to GND on target, may be used by STLINK-V3SET for detection of connection.

9.2 Connectors on MB1440 board

9.2.1 STDC14 (STM32 JTAG/SWD and VCP)

The STDC14 CN1 connector on MB1440 replicates the STDC14 CN1 connector from MB1441 board. Refer to 11.1.2 for details.

9.2.2 Legacy Arm 20-pin JTAG/SWD IDC connector

The CN2 connector allows the connection to an STM32 target in the JTAG or SWD mode. Its pinout is listed in [Table 7](#). It is compatible with the pinout of ST-LINK/V2.

Table 7. Legacy Arm 20-pin JTAG/SWD IDC connector CN2

Pin number	Description	Pin number	Description
1	T_VCC ⁽¹⁾	2	NC
3	NC	4	GND ⁽²⁾
5	T_JTDI/NC ⁽³⁾	6	GND ⁽²⁾
7	T_JTMS/T_SWDIO	8	GND ⁽²⁾
9	T_JCLK/T_SWCLK	10	GND ⁽²⁾
11	T_JRCLK ⁽⁴⁾ /NC ⁽³⁾	12	GND ⁽²⁾
13	T_JTDO/T_SWO ⁽⁵⁾	14	GND ⁽²⁾
15	T_NRST	16	GND ⁽²⁾
17	NC	18	GND ⁽²⁾
19	NC	20	GND ⁽²⁾

1. Input for STLINK-V3SET.
2. At least one of these pins must be connected to the ground on target side for correct behavior (connecting all is recommended for noise reduction on the ribbon).
3. NC means not required for SWD connection.
4. Optional loopback of T_JCLK on target side, required if loopback removed on STLINK-V3SET side.
5. SWO is optional, required only for Serial Wire Viewer (SWV) trace.

9.2.3 Virtual COM port connector

The CN3 connector allows the connection of a target UART for Virtual COM port function. The debug connection (through JTAG/SWD or SWIM) is not required in the same time; however a GND connection between STLINK-V3SET and target is required and must be ensured in some other way in case no debug cable is plugged. The related pinout for the VCP connector is listed in [Table 8](#).

Table 8. Virtual COM port connector CN3

Pin number	Description	Pin number	Description
1	T_VCP_TX	2	T_VCP_RX

9.2.4 SWIM connector

The CN4 connector allows the connection to an STM8 SWIM target. The related pinout for the SWIM connector is listed in [Table 9](#).

Table 9. SWIM connector CN4

Pin number	Description
1	T_VCC ⁽¹⁾
2	SWIM_DATA
3	GND
4	T_NRST

1. Input for STLINK-V3SET.

9.2.5 CAN connector

The CN5 connector allows the connection to a CAN target without a CAN transceiver. The related pinout for this connector is listed in [Table 10](#).

Table 10. CAN connector CN5

Pin number	Description
1	T_CAN_VCC ⁽¹⁾
2	T_CAN_TX
3	T_CAN_RX

1. Input for STLINK-V3SET.

9.2.6 SWD connector

The CN6 connector allows the connection to an STM32 target in SWD mode through wires. It is not recommended for high performance. The related pinout for this connector is listed in [Table 11](#).

Table 11. SWD (wires) connector CN6

Pin number	Description
1	T_VCC ⁽¹⁾
2	T_SWCLK
3	GND
4	T_SWDIO
5	T_NRST
6	T_SWO ⁽²⁾

1. Input for STLINK-V3SET.

2. Optional, required only for Serial Wire Viewer (SWV) trace.

9.2.7 UART bridge connector

Some bridge functions are provided on a 2x5-pin connector with 1.27 mm pitch CN7. The related pinout is listed in [Table 12](#).

Table 12. UART bridge connector CN7

Pin number	Description	Pin number	Description
1	UART_CTS	2	I2C_SDA
3	UART_TX ⁽¹⁾	4	CAN_TX ⁽¹⁾
5	UART_RX ⁽²⁾	6	CAN_RX ⁽²⁾
7	UART_RTS	8	I2C_SCL
9	GND	10	Reserved ⁽³⁾

1. TX signals are outputs for STLINK-V3SET, inputs for target.

2. RX signals are inputs for STLINK-V3SET, outputs for target.

- Do not connect on target

9.2.8 SPI bridge connector

Some bridge functions are provided on a 2x5-pin connector with 1.27 mm pitch CN8. The related pinout is listed in [Table 13](#).

Table 13. SPI bridge connector CN8

Pin number	Description	Pin number	Description
1	SPI_NSS	2	Bridge_GPIO0
3	SPI_MOSI	4	Bridge_GPIO1
5	SPI_MISO	6	Bridge_GPIO2
7	SPI_SCK	8	Bridge_GPIO3
9	GND	10	Reserved ⁽¹⁾

- Do not connect on target.

9.2.9 Bridge 20-pins connector

All bridge functions are provided on a 2x10-pin connector with 2.0 mm pitch CN9. The related pinout is listed in [Table 14](#).

Table 14. Bridge connector CN9

Pin number	Description	Pin number	Description
1	SPI_NSS	11	Bridge_GPIO0
2	SPI_MOSI	12	Bridge_GPIO1
3	SPI_MISO	13	Bridge_GPIO2
4	SPI_SCK	14	Bridge_GPIO3
5	GND	15	Reserved ⁽¹⁾
6	Reserved ⁽¹⁾	16	GND
7	I2C_SCL	17	UART_RTS
8	CAN_RX ⁽²⁾	18	UART_RX ⁽²⁾
9	CAN_TX ⁽³⁾	19	UART_TX ⁽³⁾
10	I2C_SDA	20	UART_CTS

- Do not connect on target.
- RX signals are inputs for STLINK-V3SET, outputs for target.
- TX signals are outputs for STLINK-V3SET, inputs for target.

10 Flat ribbons

The STLINK-V3SET provides three flat cables allowing the connection from the STDC14 output to:

- STDC14 connector (1.27 mm pitch) on target application: pinout detailed in [Table 6](#)
- ARM10-compatible connector (1.27 mm pitch) on target application: pinout detailed in [Table 15](#)
- ARM20-compatible connector (1.27 mm pitch) on target application: pinout detailed in [Table 16](#)

Table 15. ARM10-compatible connector pinout (target side)

Pin No.	Description	Pin No.	Description
1	T_VCC ⁽¹⁾	2	T_JTMS/T_SWDIO
3	GND	4	T_JCLK/T_SWCLK
5	GND	6	T_JTDO/T_SWO ⁽²⁾
7	T_JRCLK ⁽³⁾ /NC ⁽⁴⁾	8	T_JTDI/NC ⁽⁴⁾
9	GNDDetect ⁽⁵⁾	10	T_NRST

1. Input for STLINK-V3SET.
2. SWO is optional, required only for Serial Wire Viewer (SWV) trace.
3. Optional loopback of T_JCLK on target side, required if loopback removed on STLINK-V3SET side.
4. NC means not required for SWD connection.
5. Connect to GND on target, may be used by STLINK-V3SET for detection of connection.

Table 16. ARM20-compatible connector pinout (target side)

Pin No.	Description	Pin No.	Description
1	T_VCC ⁽¹⁾	2	T_JTMS/T_SWDIO
3	GND	4	T_JCLK/T_SWCLK
5	GND	6	T_JTDO/T_SWO ⁽²⁾
7	T_JRCLK ⁽³⁾ /NC ⁽⁴⁾	8	T_JTDI/NC ⁽⁴⁾
9	GNDDetect ⁽⁵⁾	10	T_NRST
11	NC	12	NC
13	NC	14	NC
15	NC	16	NC
17	NC	18	NC
19	NC	20	NC

1. Input for STLINK-V3SET.
2. SWO is optional, required only for Serial Wire Viewer (SWV) trace.
3. Optional loopback of T_JCLK on target side, required if loopback removed on STLINK-V3SET side.
4. NC means not required for SWD connection.
5. Connect to GND on target, may be used by STLINK-V3SET for detection of connection.

11 Software configuration

11.1 Supporting toolchains (not exhaustive)

[Table 17](#) gives a list of the first toolchain version supporting the STLINK-V3SET product.

Table 17. Toolchain versions supporting STLINK-V3SET

Toolchain	Description	Minimum Version
STM32CubeProgrammer	ST Programming tool for ST microcontrollers	1.1.0
SW4STM32	Free IDE on Windows, Linux and macOS	2.4.0
IAR EWARM	Third party debugger for STM32	8.20
Keil MDK-ARM	Third party debugger for STM32	5.26
STVP	ST Programming tool for ST microcontrollers	3.4.1
STVD	ST Debugging tool for STM8	4.3.12

Note: Some of the very first toolchain versions supporting the STLINK-V3SET (in runtime) might not install the complete USB driver for STLINK-V3SET (especially the STLINK-V3SET bridge USB interface description might miss). In that case, either use a more recent version of the toolchain, or update the ST-LINK driver from www.st.com (see [Section 11.2](#)).

11.2 Drivers and firmware upgrade

The STLINK-V3SET requires drivers to be installed on Windows, and embeds a firmware which needs to be updated from time to time in order to benefit from new functionality or corrections. Refer to the *Overview of ST-LINK derivatives* technical note (TN1235) for details.

11.3 STLINK-V3SET frequency selection

The STLINK-V3SET can run internally at 3 different frequencies:

- high-performance frequency
- standard frequency, compromising between performance and consumption
- low-consumption frequency

By default, the STLINK-V3SET starts in high-performance frequency. It is the responsibility of the toolchain provider to propose or not the frequency selection at user's level.

11.4 Mass storage interface

The STLINK-V3SET implements a virtual mass storage interface allowing the programming of an STM32 target flash memory with drag-and-drop action of a binary file from a file explorer. This ability requires the STLINK-V3SET to identify the connected target before enumerating on the USB host. As a consequence, this functionality is available only if the

target is connected to the STLINK-V3SET before the STLINK-V3SET is plugged to the host. This functionality is not available for STM8 targets.

11.5 Bridge interface

The STLINK-V3SET implements an USB interface dedicated to bridge functions from USB to SPI/I²C/CAN/UART/GPIOs of ST microcontroller target. This interface is firstly used by STM32CubeProgrammer in order to allow target programming through SPI/I²C/CAN bootloader.

A host software API is provided in order to extend the use cases.

12 Product STLINK-V3SET revision history and limitations

[Table 18](#) presents the history and limitations of the product.

Table 18. Product STLINK-V3SET revision history and limitations

Product finish good	Product version	Board	Version	Revision details	Known limitations
LKV3SET\$AT1	1	MB1440 MB1441	B-01 B-01	-	-

Appendix A Federal Communications Commission (FCC)

15.3 FCC Compliance Statement

15.3.1 Part 15.19

Part 15.19

This device complies with Part 15 of the FCC Rules. Operation is subject to the following two conditions: (1) this device may not cause harmful interference, and (2) this device must accept any interference received, including interference that may cause undesired operation.

Part 15.21

Any changes or modifications to this equipment not expressly approved by STMicroelectronics may cause harmful interference and void the user's authority to operate this equipment.

Part 15.105

This equipment has been tested and found to comply with the limits for a Class B digital device, pursuant to part 15 of the FCC Rules. These limits are designed to provide reasonable protection against harmful interference in a residential installation. This equipment generates uses and can radiate radio frequency energy and, if not installed and used in accordance with the instruction, may cause harmful interference to radio communications. However, there is no guarantee that interference will not occur in a particular installation. If this equipment does cause harmful interference to radio or television reception which can be determined by turning the equipment off and on, the user is encouraged to try to correct interference by one or more of the following measures:

- Reorient or relocate the receiving antenna.
- Increase the separation between the equipment and receiver.
- Connect the equipment into an outlet on circuit different from that to which the receiver is connected.
- Consult the dealer or an experienced radio/TV technician for help.

Note: Use USB cable with length lower than 0.5m and added ferrite on PC's side.

Other certifications

- EN 55032 (2012) / EN 55024 (2010)
- CFR 47, FCC Part 15, Subpart B (Class B Digital Device) and Industry Canada ICES-003 (Issue 6/2016)
- Electrical Safety qualification for CE marking: EN 60950-1 (2006+A11/2009+A1/2010+A12/2011+A2/2013)
- IEC 60650-1 (2005+A1/2009+A2/2013)

Note: The sample examined must be powered by a power supply unit or auxiliary equipment complying with standard EN 60950-1: 2006+A11/2009+A1/2010+A12/2011+A2/2013, and must be Safety Extra Low Voltage (SELV) with limited power capability.

Revision history

Table 19. Document revision history

Date	Revision	Changes
6-Sep-2018	1	Initial release.

IMPORTANT NOTICE – PLEASE READ CAREFULLY

STMicroelectronics NV and its subsidiaries ("ST") reserve the right to make changes, corrections, enhancements, modifications, and improvements to ST products and/or to this document at any time without notice. Purchasers should obtain the latest relevant information on ST products before placing orders. ST products are sold pursuant to ST's terms and conditions of sale in place at the time of order acknowledgement.

Purchasers are solely responsible for the choice, selection, and use of ST products and ST assumes no liability for application assistance or the design of Purchasers' products.

No license, express or implied, to any intellectual property right is granted by ST herein.

Resale of ST products with provisions different from the information set forth herein shall void any warranty granted by ST for such product.

ST and the ST logo are trademarks of ST. All other product or service names are the property of their respective owners.

Information in this document supersedes and replaces information previously supplied in any prior versions of this document.

© 2018 STMicroelectronics – All rights reserved