

GPS Passive Antenna

Model : GPS-ANT043



1 Part Number

GPS-ANT043

2 Dimension (Unit : mm)

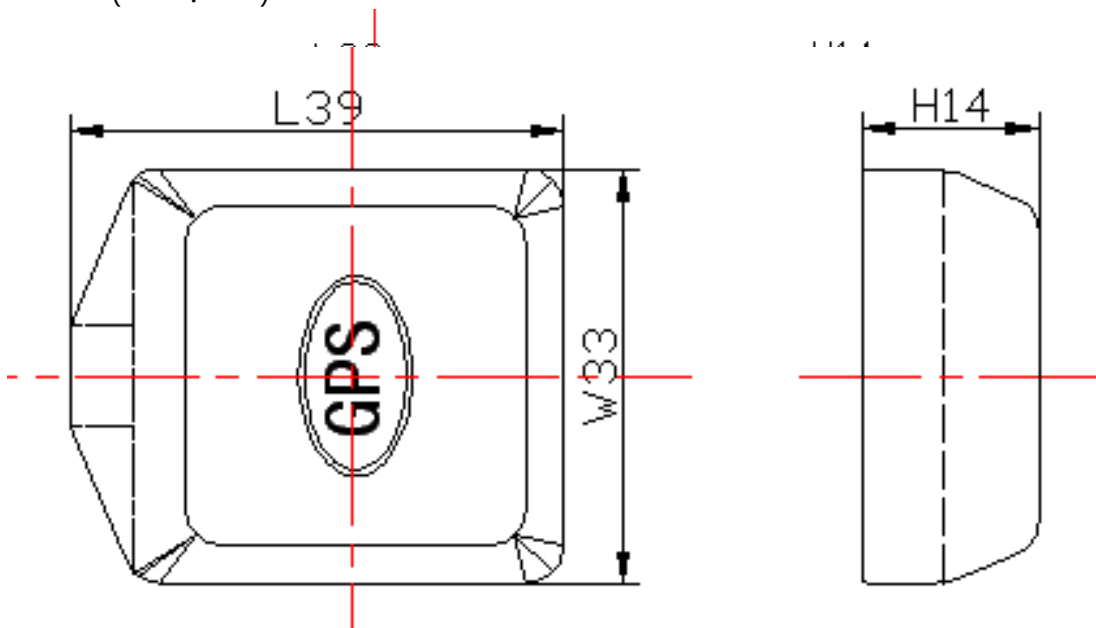

3 Electrical Characteristics

3.1 Dielectric Antenna

Form 1

No.	Item	Specifications	Post Environmental Tolerance
1	Center Frequency (MHz)	1575.42 MHz	± 3 MHz
2	Band Width (MHz)	± 5 MHz	± 1 MHz
3	V.S.W.R (in BW)	1.5 : 1	—
4	Gain (Zenith)	3 dB	± 0.5 dB
5	Polarization	RHCP	—
6	Impedance	50 Ω	—

3.2 Mechanical

Form 2

No.	Item	Specification
1	Cable	RG174 3m/5m or others
2	Connector	SMA/SMB/MCX or others
3	Plastic Housing	Black
4	Mounting	Magnet/Adhesive

4 Reliability

Condition : Temperature: $40 \pm 5^\circ\text{C}$

Load: DC= $5\text{V} \pm 0.5\text{V}$

Quantity: 2000pcs

Sustained Time: 480h

5 Environmental Specifications

Post Environmental Tolerance (Refer to the form 1)

Condition : Temperature range $25 \pm 3^\circ\text{C}$

Relative Humidity range 55~75%RH

Operating Temperature range $-40^\circ\text{C} \sim +85^\circ\text{C}$

Storage Temperature range $-40^\circ\text{C} \sim +100^\circ\text{C}$

5.1 Moisture Proof

The device should satisfy the electrical characteristics specified in form 1 after exposed to the temperature $40 \pm 2^\circ\text{C}$ and the relative humidity 90~95% RH for 96 hours and 1~2 hours recovery time under normal condition.

5.2 Vibration Resist

The device should satisfy the electrical characteristics specified in form 1 after applied to the vibration of 10 to 55Hz with amplitude of 1.5mm for 2 hours each in X , Y and Z directions.

5.3 Drop Shock

The device should satisfy the electrical characteristics specified in form 1 after dropping onto the hard wooden board from the height of 30cm for 3 times each facet of the 3 dimensions of the device.

5.4 High Temperature Endurance

The device should satisfy the electrical characteristics specified in form 1 after exposed to temperature $80 \pm 5^{\circ}\text{C}$ for 24 ± 2 hours and 1~2 hours recovery time under normal temperature.

5.5 Low Temperature Endurance

The device should also satisfy the electrical characteristics specified in form 1 after exposed to the temperature $-40^{\circ}\text{C} \pm 5^{\circ}\text{C}$ for 24 ± 2 hours and to 2 hours recovery time under normal temperature.

5.6 Temperature Cycle Test

The device should also satisfy the electrical characteristics specified in form 1 after exposed to the low temperature -25°C and high temperature $+85^{\circ}\text{C}$ for 30 ± 2 min each by 5 cycles and 1 to 2 hours recovery time under normal temperature.

6 Weatherproof

Put the antennas in 1m deep water for 12h, and find 100% waterproof.