

Synchronous Buck Regulators 28 V Input, 12 A (SiC437) and 8 A (SiC438)

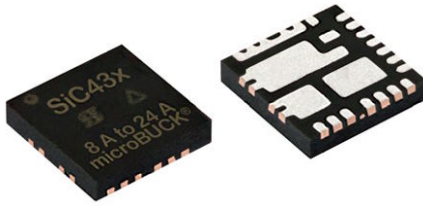

DESCRIPTION

The SiC43x family of devices are synchronous buck regulators with integrated high side and low side power MOSFETs. Its power stage is capable of supplying 12 A (SiC437) and 8 A (SiC438) continuous current at up to 1 MHz switching frequency. This regulator produces an adjustable output voltage down to 0.6 V from 3 V to 28 V input rail to accommodate a variety of applications, including computing, consumer electronics, telecom, and industrial.

SiC437's and SiC438's architecture delivers ultrafast transient response with minimum output capacitance and tight ripple regulation at very light load. The device is internally compensated and is stable with any capacitor. No external ESR network is required for loop stability purposes. The device also incorporates a power saving scheme that significantly increases light load efficiency.

The regulator family integrates a full protection feature set, including output overvoltage protection (OVP), cycle by cycle overcurrent protection (OCP) short circuit protection (SCP) and thermal shutdown (OTP). It also has UVLO and a user programmable soft start.

The SiC437 and SiC438 are available in lead (Pb)-free power enhanced MLP-24L package in 4 mm x 4 mm dimension.

APPLICATIONS

- 5 V, 12 V, and 24 V input rail POLs
- Desktop, notebooks, server, and industrial computing
- Industrial and automation
- consumer electronics

TYPICAL APPLICATION CIRCUIT AND PACKAGE OPTIONS

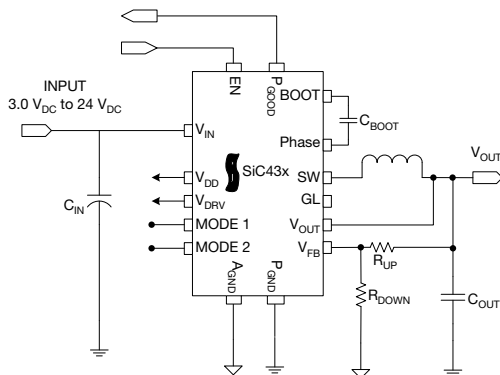

Fig. 1 - Typical Application Circuit

FEATURES

- Versatile
 - Operation from 3 V to 28 V input voltage (4.5 V to 28 V using single supply)
 - Adjustable output voltage down to 0.6 V
 - Scalable solution 8 A (SiC438), 12 A (SiC437), and 24 A (SiC431)
 - Output voltage tracking and sequencing with pre-bias start up
 - $\pm 1\%$ output voltage accuracy at $-40\text{ }^{\circ}\text{C}$ to $+125\text{ }^{\circ}\text{C}$
- Highly efficient
 - 97 % peak efficiency
 - 1 μA supply current at shutdown
 - 50 μA operating current not switching
- Highly configurable
 - Four programmable switching frequencies available: 300 kHz, 500 kHz, 750 kHz, and 1 MHz
 - Adjustable soft start (4.5 ms / 9 ms) and adjustable current limit
 - Three modes of operation
 - Forced continuous conduction, power save (SiC43xB), or ultrasonic (SiC43xA)
- Robust and reliable
 - Cycle-by-cycle current limit
 - Output overvoltage protection
 - Output undervoltage / short circuit protection with auto retry
 - Power good flag and over temperature protection
- Design tools
 - Supported by Vishay PowerCAD Online Design Simulation (www.vishay.com/power-ics/powercad-list/)
 - Evaluation board (www.vishay.com/doc?#####)



RoHS
COMPLIANT
HALOGEN
FREE

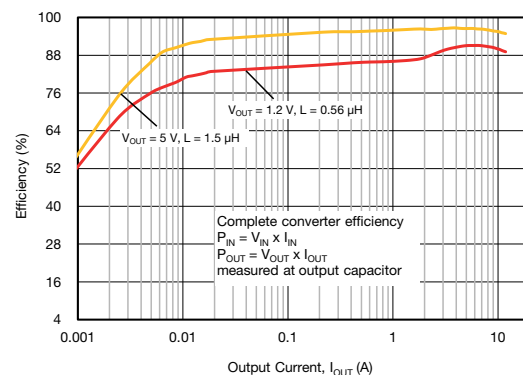
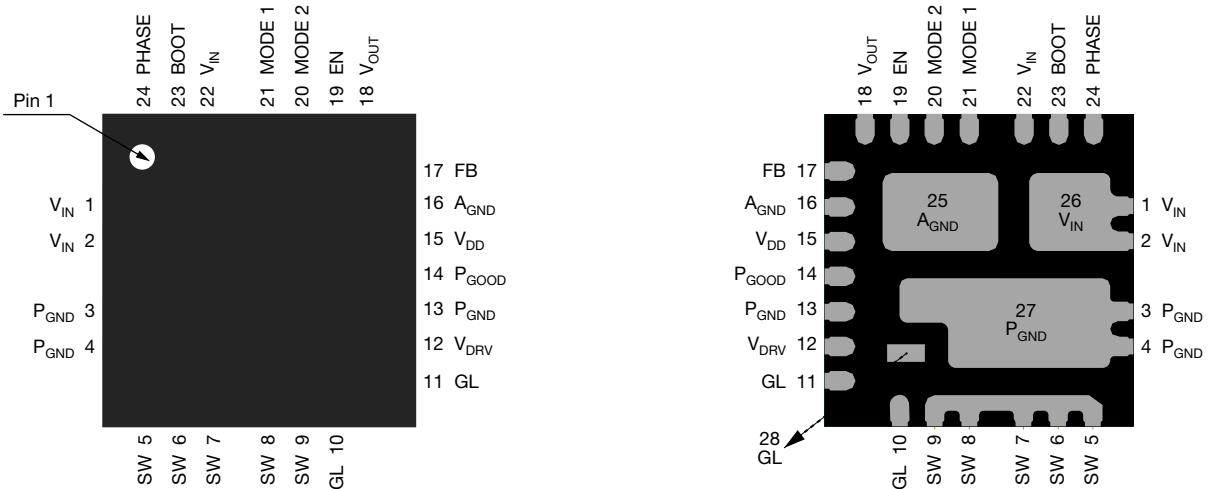

Fig. 2 - Efficiency vs. Output Current
($V_{IN} = 12\text{ V}$, $f_{sw} = 500\text{ kHz}$, Power Saving Mode)

PIN CONFIGURATION

Fig. 3 - SiC43x Pin Configuration

PIN DESCRIPTION		
PIN NUMBER	SYMBOL	DESCRIPTION
1, 2, 22, 26	V_{IN}	Input voltage
3, 4, 13, 27	P_{GND}	Power signal return ground
5 to 9	SW	Switching node signal; output inductor connection point
10, 11	GL	Low side power MOSFET gate signal
12	V_{DRV}	Supply voltage for internal gate driver. Connect a 2.2 μF decoupling capacitor to P_{GND}
14	P_{GOOD}	Power good signal output; open drain
15	V_{DD}	Supply voltage for internal logic. Connect a 1 μF decoupling capacitor to A_{GND}
16, 25	A_{GND}	Analog signal return ground
17	FB	Output voltage feedback pin; connect to V_{OUT} through a resistor divider network.
18	V_{OUT}	Output voltage sense pin
19	EN	Enable pin
20	MODE 2	Connect a resistor to V_{DD} to set the soft start timing at 9 ms and current limit level; connect a resistor to A_{GND} to set the soft start timing at 4.5 ms and current limit level
21	MODE 1	Connect a resistor to V_{DD} for CCM and switching frequency setting; connect a resistor to A_{GND} for DCM and switching frequency setting
23	BOOT	Bootstrap pin; connect a capacitor to PHASE pin for HS power MOSFET gate voltage supply
24	PHASE	Switching node signal for bootstrap return path

ORDERING INFORMATION						
PART NUMBER	PART MARKING	MAXIMUM CURRENT	V_{DD} , V_{DRV}	LIGHT LOAD MODE	JUNCTION TEMPERATURE RANGE	PACKAGE
SiC437AED-T1-GE3	SiC437A	12 A	Internal	Ultrasonic	-40 °C to +125 °C	PowerPAK® MLP44-24L
SiC437BED-T1-GE3	SiC437B			Power saving		
SiC437CED-T1-GE3	SiC437C		External	Ultrasonic		
SiC437DED-T1-GE3	SiC437D			Power saving		
SiC438AED-T1-GE3	SiC438A	8 A	Internal	Ultrasonic		
SiC438BED-T1-GE3	SiC438B			Power saving		
SiC438CED-T1-GE3	SiC438C		External	Ultrasonic		
SiC438DED-T1-GE3	SiC438D			Power saving		



ABSOLUTE MAXIMUM RATINGS ($T_A = 25\text{ }^\circ\text{C}$, unless otherwise noted)			
ELECTRICAL PARAMETER	CONDITIONS	LIMITS	UNIT
V_{IN}	Reference to P_{GND}	-0.3 to +30	V
V_{OUT}	Reference to P_{GND}	-0.3 to +22	
V_{DD} / V_{DRV}	Reference to P_{GND}	-0.3 to +6	
SW / PHASE	Reference to P_{GND}	-0.3 to +30	
SW / PHASE (AC)	100 ns; reference to P_{GND}	-4 to +35; negative side = -8 V with 100 ns duration	
BOOT		-0.3 to +6	
BOOT to SW		-0.3 to +6	
A_{GND} to P_{GND}		-0.3 to +0.3	
EN		-0.3 to +30	
All other pins	Reference to A_{GND}	-0.3 to +6	
Temperature			
Junction temperature	T_J	-40 to +150	$^\circ\text{C}$
Storage temperature	T_{STG}	-65 to +150	
Power Dissipation			
Junction to ambient thermal impedance ($R_{\theta JA}$)		16	$^\circ\text{C}/\text{W}$
Junction to case thermal impedance ($R_{\theta JC}$)		2	
Maximum power dissipation	Ambient temperature = $25\text{ }^\circ\text{C}$	6.25	W
ESD Protection			
Electrostatic discharge protection	Human body model	4000	V
	Charged device model	1000	

Stresses beyond those listed under "Absolute Maximum Ratings" may cause permanent damage to the device. These are stress ratings only, and functional operation of the device at these or any other conditions beyond those indicated in the operational sections of the specifications is not implied. Exposure to absolute maximum rating/conditions for extended periods may affect device reliability.

RECOMMENDED OPERATING CONDITIONS (all voltages referenced to GND = 0 V)				
PARAMETER	MIN.	TYP.	MAX.	UNIT
Input voltage (V_{IN})	4.5	-	28	V
Enable (EN)	0	-	28	
Input voltage (V_{IN}), external supply on V_{DD} / V_{DRV}	3	-	28	
Output voltage (V_{OUT})	0.6	-	$0.9 \times V_{IN}$ (max. 20 V)	
Temperature				
Recommended ambient temperature		-40 to +105		$^\circ\text{C}$
Operating junction temperature		-40 to +125		



ELECTRICAL SPECIFICATIONS ($V_{IN} = 12\text{ V}$, $T_J = -40\text{ }^\circ\text{C}$ to $+125\text{ }^\circ\text{C}$, unless otherwise stated)						
PARAMETER	SYMBOL	TEST CONDITIONS	MIN.	TYP.	MAX.	UNIT
Power Supplies						
V_{DD} supply	V_{DD}	$V_{IN} = 6\text{ V to }24\text{ V}$, $V_{EN} = 5\text{ V}$, not switching	4.75	5	5.25	V
V_{DD} UVLO threshold, rising	V_{DD_UVLO}		3	3.3	3.6	
V_{DD} UVLO hysteresis	$V_{DD_UVLO_HYST}$		-	300	-	mV
Maximum V_{DD} current	I_{DD}	$V_{IN} = 6\text{ V to }24\text{ V}$	3	-	-	mA
V_{DRV} supply	V_{DRV}	$V_{IN} = 6\text{ V to }24\text{ V}$, $V_{EN} = 5\text{ V}$, not switching	4.75	5	5.25	V
Maximum V_{DRV} current	I_{DRV}	$V_{IN} = 6\text{ V to }24\text{ V}$	50	-	-	mA
Input current	I_{VIN}	Non-switching, $V_{FB} > 0.6\text{ V}$	-	50	120	μA
Shutdown current	I_{VIN_SHDN}	$V_{EN} = 0\text{ V}$	-	0.5	3	
Controller and Timing						
Feedback voltage	V_{FB}	$T_J = 25\text{ }^\circ\text{C}$	597	600	603	mV
		$T_J = -40\text{ }^\circ\text{C}$ to $+125\text{ }^\circ\text{C}$ (1)	594	600	606	
V_{FB} input bias current	I_{FB}		-	2	-	nA
Minimum on-time	$t_{ON_MIN.}$		-	50	65	ns
t_{ON} accuracy	$t_{ON_ACCURACY}$		-10	-	10	%
On-time range	t_{ON_RANGE}		65	-	2250	ns
Minimum frequency, skip mode	f_{kHz}	Ultrasonic version (SiC43xA)	20	-	-	kHz
		Power save version (SiC43xB)	0	-	-	
Minimum off-time	$t_{OFF_MIN.}$		205	250	305	ns
Power MOSFETs (SiC437)						
High side on resistance	R_{ON_HS}	$V_{DRV} = 5\text{ V}$, $T_A = 25\text{ }^\circ\text{C}$	-	10.1	-	m Ω
Low side on resistance	R_{ON_LS}		-	3.9	-	
Power MOSFETs (SiC438)						
High side on resistance	R_{ON_HS}	$V_{DRV} = 5\text{ V}$, $T_A = 25\text{ }^\circ\text{C}$	-	10.1	-	m Ω
Low side on resistance	R_{ON_LS}		-	5.5	-	
Fault Protections						
Valley current limit	I_{OCL}	$T_J = -10\text{ }^\circ\text{C}$ to $+125\text{ }^\circ\text{C}$	-20	-	20	%
Output OVP threshold	OVP	V_{FB} with respect to 0.6 V reference	-	20	-	
Output UVP threshold	UVP		-	-80	-	
Over temperature protection	OTPR	Rising temperature	-	150	-	$^\circ\text{C}$
	OTPHYST	Hysteresis	-	25	-	
Power Good						
Power good output threshold	$V_{FB_RISING_VTH_OV}$	V_{FB} rising above 0.6 V reference	-	20	-	%
	$V_{FB_FALLING_VTH_UV}$	V_{FB} falling below 0.6 V reference	-	-10	-	
Power good hysteresis	P_{GOOD_HYST}		-	40	-	mV
Power good on resistance	R_{ON_PGOOD}		-	7.5	15	Ω
Power good delay time	t_{DLY_PGOOD}		15	25	35	μs
EN / MODE / Ultrasonic Threshold						
EN logic high level	V_{EN_H}		1.6	-	-	V
EN logic low level	V_{EN_L}		-	-	0.4	
EN pull down resistance	R_{EN}		-	5	-	M Ω
Switching Frequency						
Switching frequency	f_{sw}	$R_{MODE1} = 51\text{ k}\Omega$	-	300	-	kHz
		$R_{MODE1} = 100\text{ k}\Omega$	-	500	-	
		$R_{MODE1} = 200\text{ k}\Omega$	-	750	-	
		$R_{MODE1} = 500\text{ k}\Omega$	-	1000	-	

ELECTRICAL SPECIFICATIONS ($V_{IN} = 12\text{ V}$, $T_J = -40\text{ }^\circ\text{C}$ to $+125\text{ }^\circ\text{C}$, unless otherwise stated)						
PARAMETER	SYMBOL	TEST CONDITIONS	MIN.	TYP.	MAX.	UNIT
Soft Start						
Soft start time	t_{ss}	Connect R_{MODE2} between MODE2 and GND	2.7	4.5	6.3	ms
		Connect R_{MODE2} between MODE2 and V_{DD}	5.4	9	12.6	
Over Current Protection - SiC437						
Over current limit (inductor valley current)	I_{OCL}	$R_{MODE2} = 500\text{ k}\Omega$	-	18	-	A
		$R_{MODE2} = 200\text{ k}\Omega$	-	14	-	
		$R_{MODE2} = 100\text{ k}\Omega$	-	9.7	-	
		$R_{MODE2} = 51\text{ k}\Omega$	-	5.4	-	
Over Current Protection - SiC438						
Over current limit (inductor valley current)	I_{OCL}	$R_{MODE2} = 500\text{ k}\Omega$	-	12	-	A
		$R_{MODE2} = 200\text{ k}\Omega$	-	9.3	-	
		$R_{MODE2} = 100\text{ k}\Omega$	-	6.5	-	
		$R_{MODE2} = 51\text{ k}\Omega$	-	3.6	-	

Note

(1) Guaranteed by design

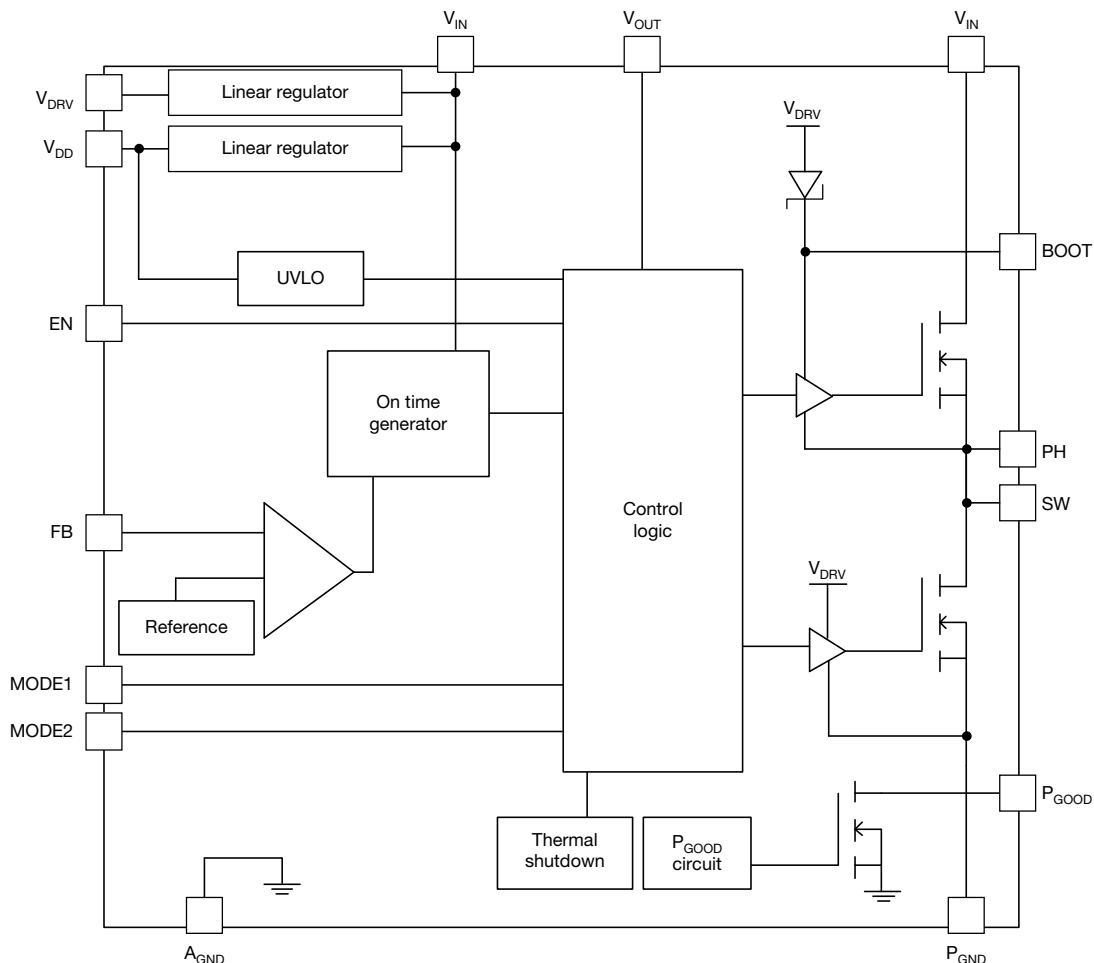
FUNCTIONAL BLOCK DIAGRAM

Fig. 4 - SiC43x Functional Block Diagram

OPERATIONAL DESCRIPTION

Device Overview

The SiC43x is high efficiency synchronous buck regulators capable of delivering up to 8 A (SiC438) and 12 A (SiC437) continuous current. The device has programmable switching frequency options of 300 kHz, 500 kHz, 750 kHz, and 1 MHz. The control scheme delivers fast transient response and minimizes external components. Thanks to the internal current ramp information, no high ESR output bulk or virtual ESR network is required for the loop stability. This device also incorporates a power saving feature by enabling diode emulation mode and frequency fold back as the load decreases.

SiC43x has a full set of protection and monitoring features:

- Over current protection in pulse-by-pulse mode
- Output over voltage protection
- Output under voltage protection with device latch
- Over temperature protection with hysteresis
- Dedicated enable pin for easy power sequencing
- Power good open drain output

This device is available in MLP44-24L package to deliver high power density and minimize PCB area.

Power Stage

SiC43x integrates a high performance power stage with a low on resistance and gate charge, high side and low side MOSFETs. The MOSFETs are optimized to achieve up to 97 % efficiency.

The input voltage (V_{IN}) can go up to 28 V and down as low as 4.5 V for power conversion. For input voltages (V_{IN}) below 4.5 V an external 5 V supply on V_{DD} and V_{DRV} is required.

Control Mechanism

SiC43x employs a voltage - mode COT control mechanism. During steady-state operation, feedback voltage is compared with internal reference (0.6 V typ.) and the amplified error signal (V_{COMP}) is generated in the internal comp node. An internally generated ramp signal and V_{COMP} are fed into a comparator. Once V_{RAMP} crosses V_{COMP} , a single shot on-time pulse is generated for a fixed time, programmed by the external R_{FSW} . During the on-time pulse, the high side MOSFET will be turned on. Once the on-time pulse expires, the low side MOSFET will be turned on after a break-before-make period. The low side MOSFET will be on for duration of minimum off-time pulse until V_{RAMP} crosses V_{COMP} . The cycle is then repeated.

Fig. 5 illustrates the basic block diagram for VM-COT architecture. In this architecture the following is achieved:

- The reference of a basic ripple control regulator is replaced with a high gain error amplifier loop
- This establishes two parallel voltage regulating feedback paths, a fast and slow path (hence V2)
- Fast path is the ripple injection which ensures rapid correction of the transient perturbation
- Slow path is the error amplifier loop which ensures the DC component of the output voltage follows the internal

accurate reference voltage

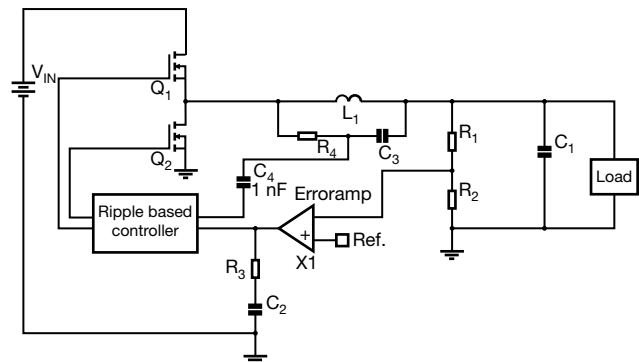

Fig. 5 - VM-COT Block Diagram

The SiC43x integrates the error amplifier compensation components (R_3 and C_2) and the ripple injection components (R_4 , C_4 , and C_3) shown in Fig. 5. Based on the operating modes, the regulator automatically picks the correct compensation and ripple injection components from an array that is available on the IC die. This reduces external components and makes the use of the SiC43x far simpler than industry standard regulators that require external components to be calculated for each voltage rail in the system.

Fig. 6 demonstrates the basic operational waveforms:

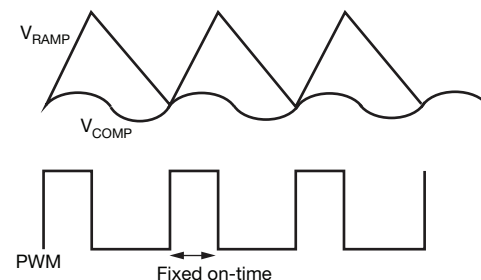

Fig. 6 - VM-COT Operational Principle

Mode Setting, Soft Start, and Frequency Selection

To improve efficiency at light-load condition, SiC43x provides a set of innovative implementations to eliminate LS re-circulating current and switching losses. The internal zero crossing detector (ZCD) monitors V_{SW} node voltage to determine when inductor current starts to flow negatively. In power saving mode, as soon as inductor valley current crosses zero, the device first deploys diode emulation mode by turning off LS FET. If load further decreases, switching frequency is further reduced proportional to load condition to save switching losses while keeping output ripple within tolerance. The switching frequency is set by the controller to maintain regulation. In the standard power save mode, there is no minimum switching frequency for SiC43xB.

For SiC43xA, the minimum switching frequency that the regulator will drop to is 25 kHz as the part avoids switching frequencies in the audible range to prevent audible noise. In this version of the part, the light load mode, is called the ultrasonic mode.

The SiC43x has a low pin count and minimum external components. To offer the user maximum flexibility to choose soft start times, current limit settings, switching frequencies and to enable or disable the light load mode, just two MODE pins are used and a particular resistor value connected to V_{DD} or GND allows the user to choose various operating modes. This is best explained by the below tables:

TABLE 1 - MODE 1 CONFIGURATION SETTINGS			
OPERATION	CONNECTION	f_{SWITCH} (kHz)	R_{MODE1} (k Ω)
Skip	To A_{GND}	300	51
		500	100
		750	200
		1000	500
Forced CCM	To V_{DD}	300	51
		500	100
		750	200
		1000	500

TABLE 2 - MODE 2 CONFIGURATION SETTINGS			
SOFT-START TIME	CONNECTION	I_{LIMIT} (%)	R_{MODE2} (k Ω)
4.5 ms	to A_{GND}	30	51
		54	100
		78	200
		100 % (18 A on SiC437) 100 % (12 A on SiC438)	500
9 ms	to V_{DD}	30	51
		54	100
		78	200
		100 % (18 A on SiC437) 100 % (12 A on SiC438)	500

OUTPUT MONITORING AND PROTECTION FEATURES

Output Overcurrent Protection (OCP)

SiC43x has pulse-by-pulse overcurrent limit control. The inductor valley current is monitored during LS FET turn-on period through $R_{DS(on)}$ sensing. After a pre-defined blanking time, the valley current is compared with internal threshold to determine the threshold for OCP. If monitored current is higher than threshold, HS turn-on pulse is skipped and LS FET is kept on until the valley current returns below OCP limit.

In the severe over-current condition, pulse-by-pulse current limit eventually triggers output undervoltage protection (UVP) and the device will go into hiccup mode as described in the next section.

OCP is enabled immediately after V_{DD} passes UVLO level.

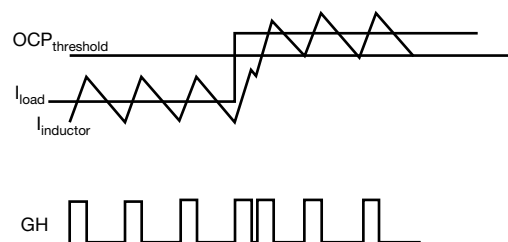

Fig. 7 - Over-Current Protection Illustration

Output Undervoltage Protection (UVP)

UVP is implemented by monitoring output through V_{FB} pin. If the voltage level at V_{FB} goes below 0.54 V for more than 25 μ s, then a UVP event is recognized and both HS and LS MOSFETs are turned off. After a period of 20 soft start cycles, the IC attempts to re-start and goes through a soft start cycle. If the fault condition still exists, the above cycle will be repeated.

UVP is only active after the completion of soft-start sequence.

Output Overvoltage Protection (OVP)

For OVP implementation, output is monitored through FB pin. After soft start, if the voltage level at FB is above 20 % (typ.), OVP is triggered with both the HS and LS MOSFETs turned off. Normal operation is resumed once FB voltage drops back to 0.672 V.

OVP is active immediately after V_{DD} passes UVLO level.

Over-Temperature Protection (OTP)

SiC43x has internal thermal monitor block that turns off both HS and LS FETs when junction temperature is above 150 °C (typ). A hysteresis of 35 °C is implemented, so when junction temperature drops below 115 °C, the device restarts by initiating soft-start sequence again.

Sequencing of Input / Output Supplies

SiC43x has no sequencing requirements on any of its input / output (V_{IN} , V_{DRV} , V_{DD} , EN) supplies or enables. In cases with input voltages below 4.5 V the V_{DD} and V_{DRV} pins must be biased first (> 5.3 V).

Enable

The SiC43x has an enable pin to turn the part on and off. Driving this pin high enables the device, while grounding it turns it off.

The SiC43x enable has a weak pull down to prevent unwanted turn on due to a floating GPIO.

There are no sequencing requirements w.r.t other input / output supplies.

Pre-Bias Start-Up

In case of pre-bias startup, output is monitored through FB pin. If the sensed voltage on FB is higher than the internal reference ramp value, control logic prevents HS and LS FET from switching to avoid negative output voltage spike and excessive current sinking through LS FET.

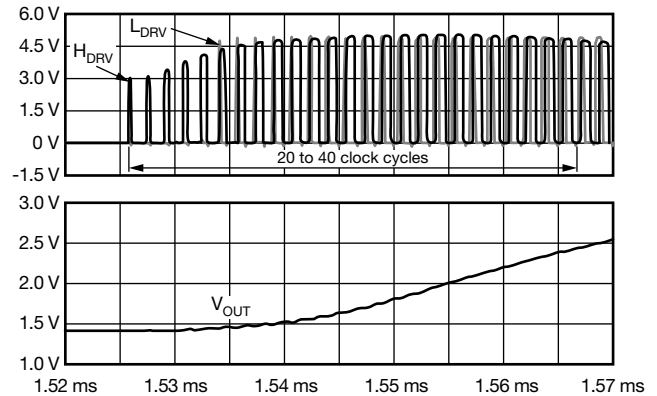

Fig. 8 - Pre-Bias Start-Up

Power Good

SiC43x's power good is an open-drain output. Pull P_{GOOD} pin high up to 5 V through a 10K resistor to use this signal. Power good window is shown in the below diagram. If voltage level on FB pin is out of this window, PG signal is de-asserted by pulling down to GND. To prevent false triggering during transient events, P_{GOOD} has a 25 μ s blanking time.

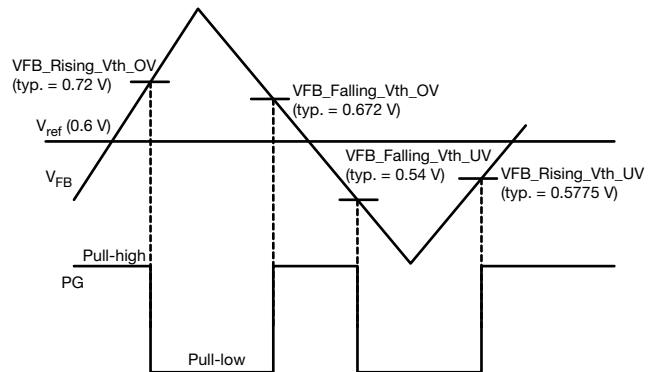

Fig. 9 - P_{GOOD} Window and Timing Diagram



ELECTRICAL CHARACTERISTICS

(VIN = 12 V, VOUT = 1.2 V, fsw = 500 kHz, COUT = 47 μF x 7, CIN = 10 μF x 6, unless otherwise noted)

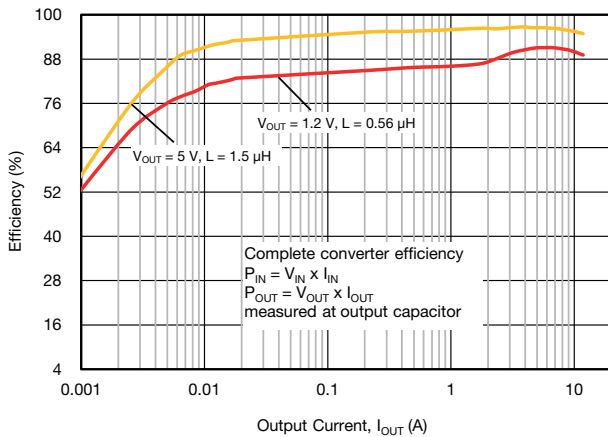

Fig. 10 - SiC437 Efficiency vs. Output Current (VIN = 12 V, fsw = 500 kHz, Power Saving Mode)

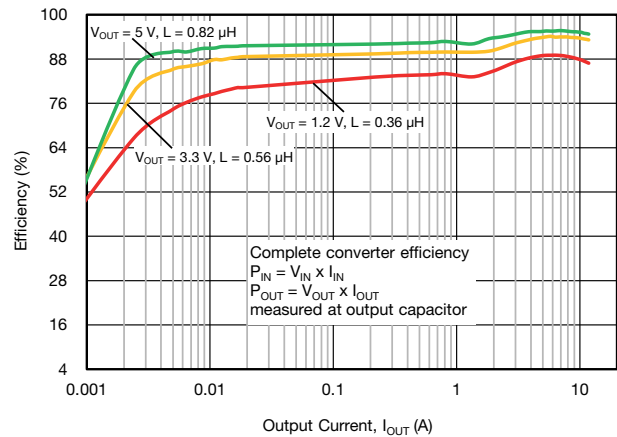

Fig. 13 - SiC437 Efficiency vs. Output Current (VIN = 12 V, fsw = 1 MHz, Power Saving Mode)

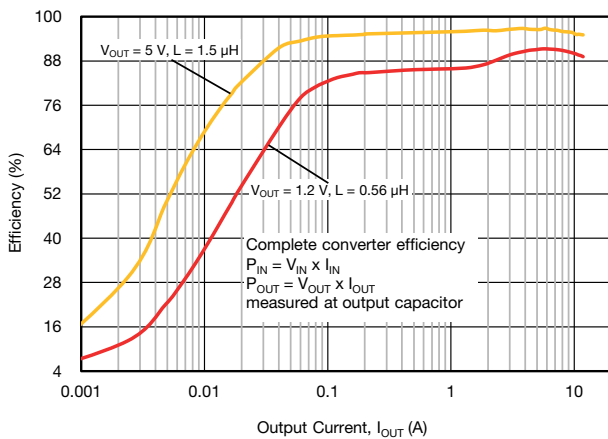

Fig. 11 - SiC437 Efficiency vs. Output Current (VIN = 12 V, fsw = 500 kHz, Ultra Sonic Mode)

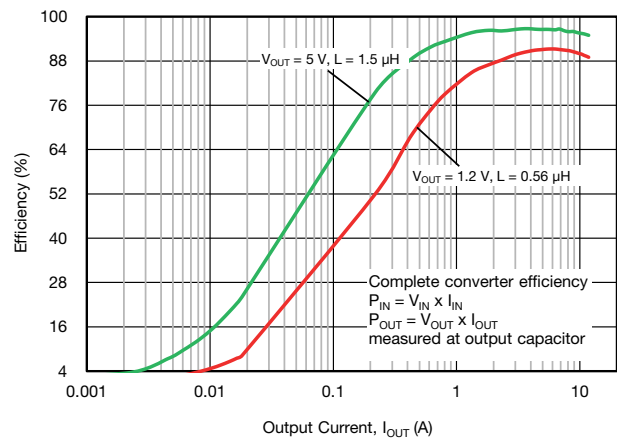

Fig. 14 - SiC437 Efficiency vs. Output Current (VIN = 12 V, fsw = 500 kHz, Continuous Conduction Mode)

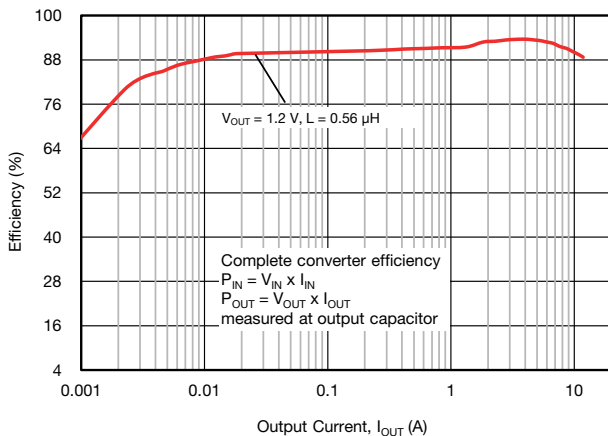

Fig. 12 - SiC437 Efficiency vs. Output Current (VIN = 5 V, fsw = 500 kHz, Power Saving Mode)

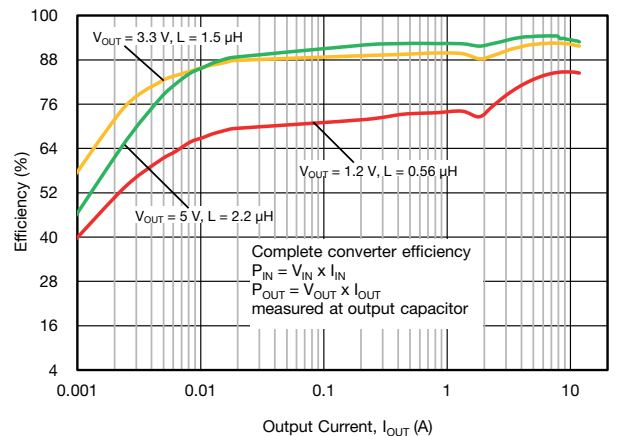

Fig. 15 - SiC437 Efficiency vs. Output Current (VIN = 24 V, fsw = 500 kHz, Power Saving Mode)

ELECTRICAL CHARACTERISTICS

($V_{IN} = 12\text{ V}$, $V_{OUT} = 1.2\text{ V}$, $f_{sw} = 500\text{ kHz}$, $C_{OUT} = 47\text{ }\mu\text{F} \times 7$, $C_{IN} = 10\text{ }\mu\text{F} \times 6$, unless otherwise noted)

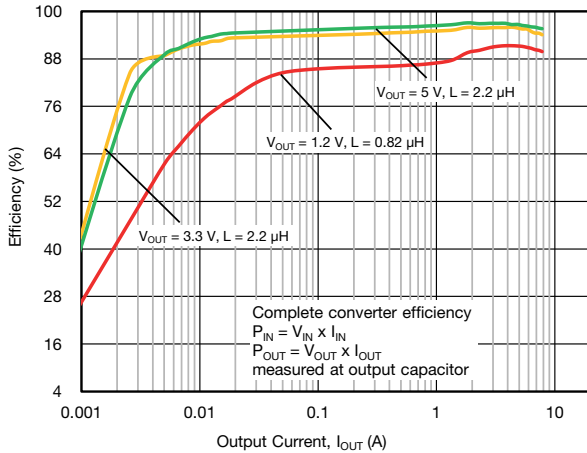

Fig. 16 - SiC438 Efficiency vs. Output Current
($V_{IN} = 12\text{ V}$, $f_{sw} = 500\text{ kHz}$, Power Saving Mode)

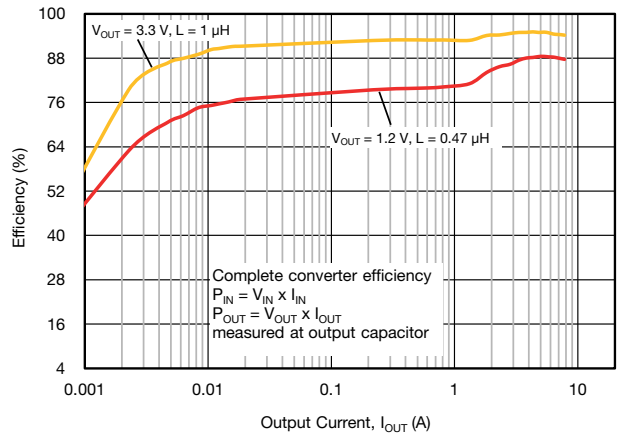

Fig. 19 - SiC438 Efficiency vs. Output Current
($V_{IN} = 12\text{ V}$, $f_{sw} = 1\text{ MHz}$, Power Saving Mode)

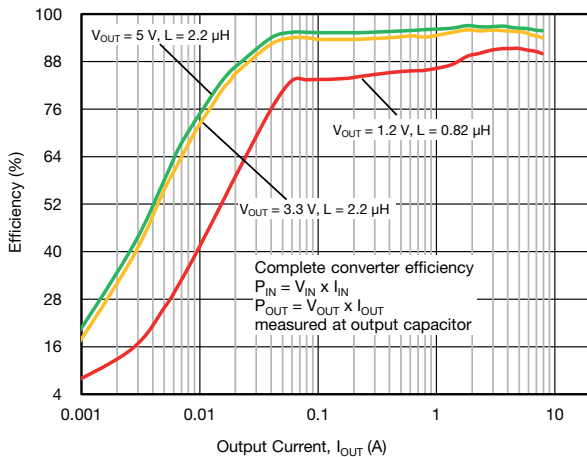

Fig. 17 - SiC438 Efficiency vs. Output Current
($V_{IN} = 12\text{ V}$, $f_{sw} = 500\text{ kHz}$, Ultra Sonic Mode)

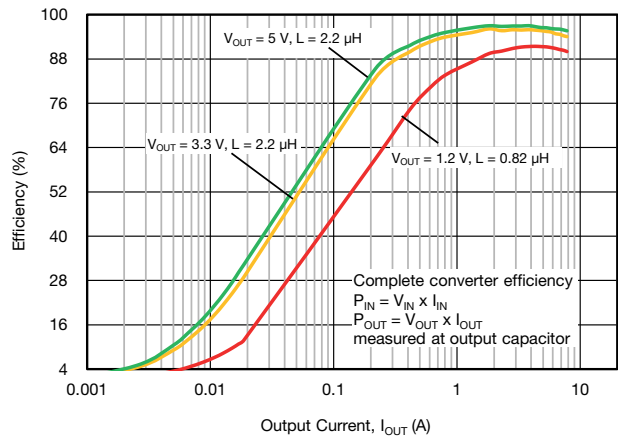

Fig. 20 - SiC438 Efficiency vs. Output Current
($V_{IN} = 12\text{ V}$, $f_{sw} = 500\text{ kHz}$, Continuous Conduction Mode)

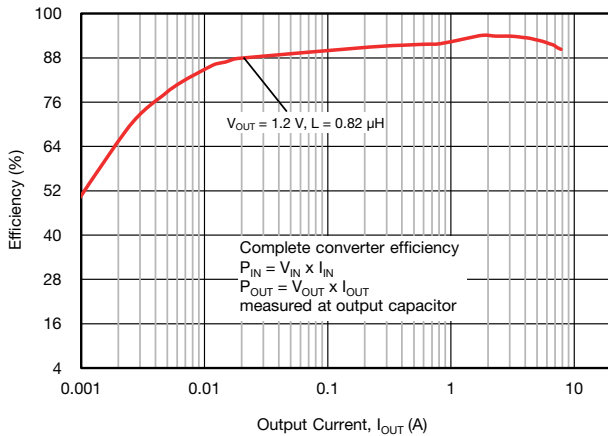

Fig. 18 - SiC438 Efficiency vs. Output Current
($V_{IN} = 5\text{ V}$, $f_{sw} = 500\text{ kHz}$, Power Saving Mode)

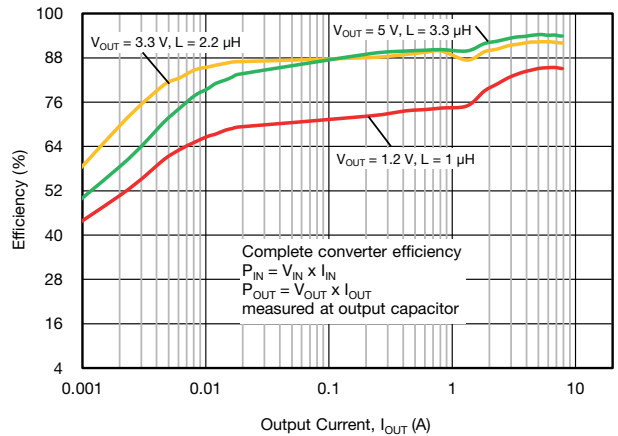
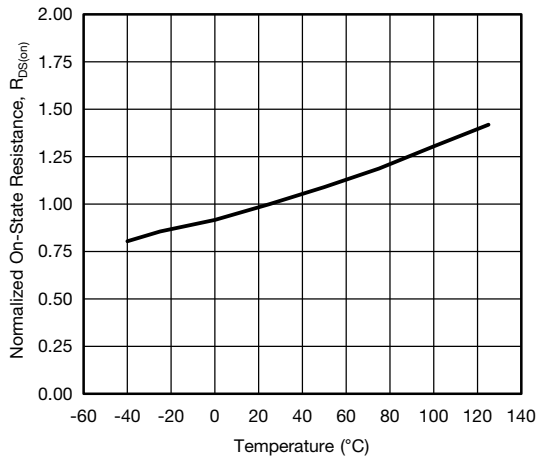
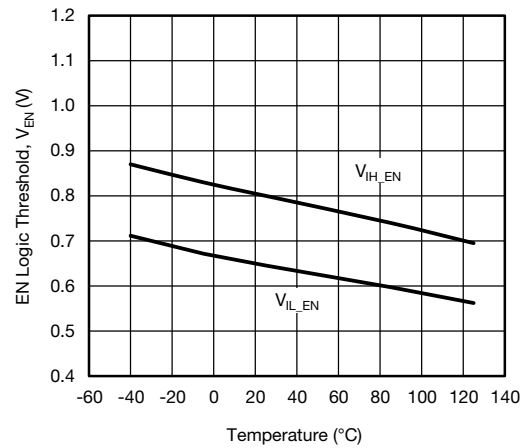
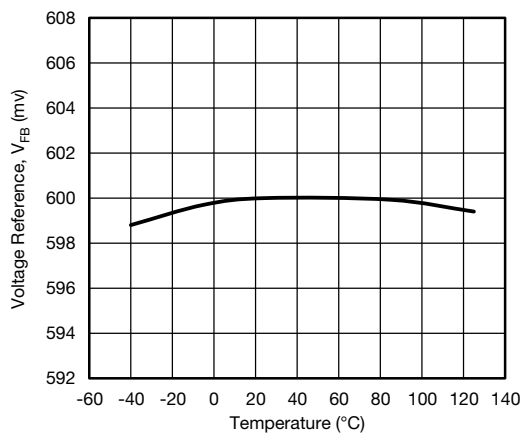
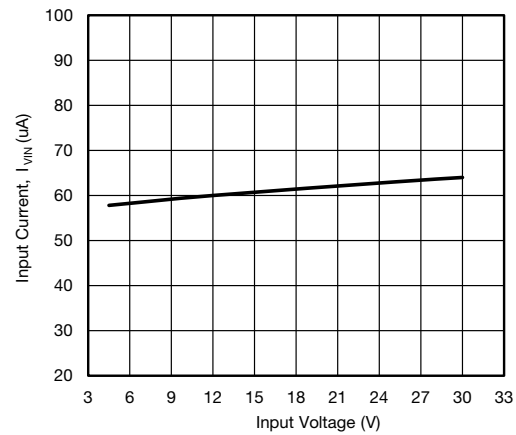
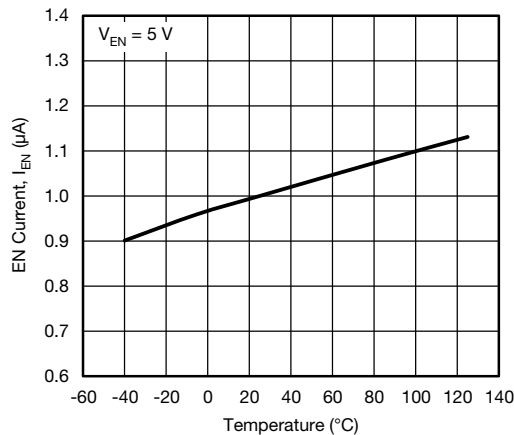
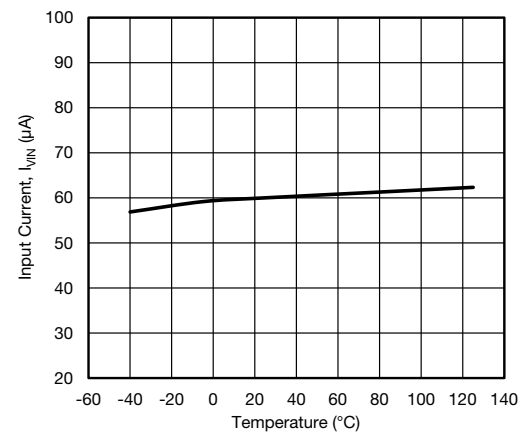

Fig. 21 - SiC438 Efficiency vs. Output Current
($V_{IN} = 24\text{ V}$, $f_{sw} = 500\text{ kHz}$, Power Saving Mode)

ELECTRICAL CHARACTERISTICS

($V_{IN} = 12\text{ V}$, $V_{OUT} = 1.2\text{ V}$, $f_{sw} = 500\text{ kHz}$, $C_{OUT} = 47\text{ }\mu\text{F} \times 7$, $C_{IN} = 10\text{ }\mu\text{F} \times 6$, unless otherwise noted)

Fig. 22 - On-Resistance vs. Junction Temperature

Fig. 25 - EN Logic Threshold vs. Junction Temperature

Fig. 23 - Voltage reference vs. Junction Temperature

Fig. 26 - Input Current vs. Input Voltage

Fig. 24 - EN Current vs. Junction Temperature

Fig. 27 - Input Current vs. Junction Temperature



ELECTRICAL CHARACTERISTICS

($V_{IN} = 12\text{ V}$, $V_{OUT} = 1.2\text{ V}$, $f_{sw} = 500\text{ kHz}$, $C_{OUT} = 47\text{ }\mu\text{F} \times 7$, $C_{IN} = 10\text{ }\mu\text{F} \times 6$, unless otherwise noted)

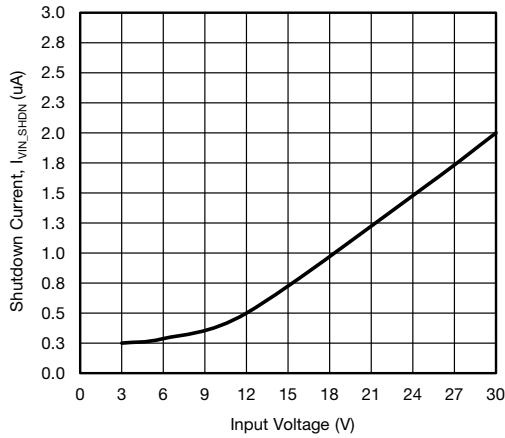

Fig. 28 - Shutdown Current vs. Input Voltage

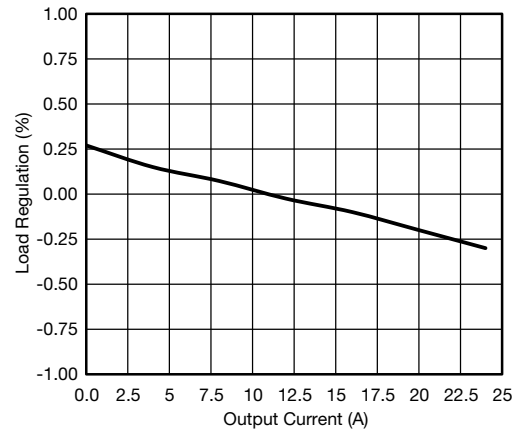

Fig. 30 - Load Regulation vs. Output Current

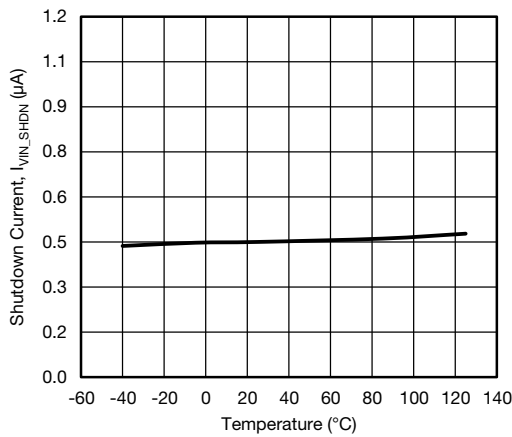

Fig. 29 - Shutdown Current vs. Junction Temperature

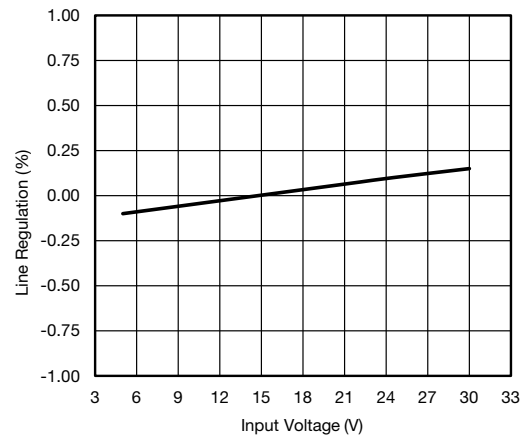

Fig. 31 - Line Regulation vs. Input Voltage

ELECTRICAL CHARACTERISTICS

($V_{IN} = 12\text{ V}$, $V_{OUT} = 1.2\text{ V}$, $f_{sw} = 500\text{ kHz}$, $C_{OUT} = 47\text{ }\mu\text{F} \times 7$, $C_{IN} = 10\text{ }\mu\text{F} \times 6$, unless otherwise noted)

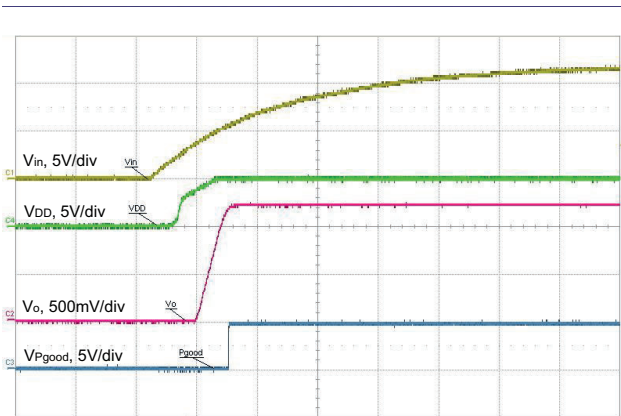

Fig. 32 - Startup with V_{IN} , $t = 5\text{ ms/div}$

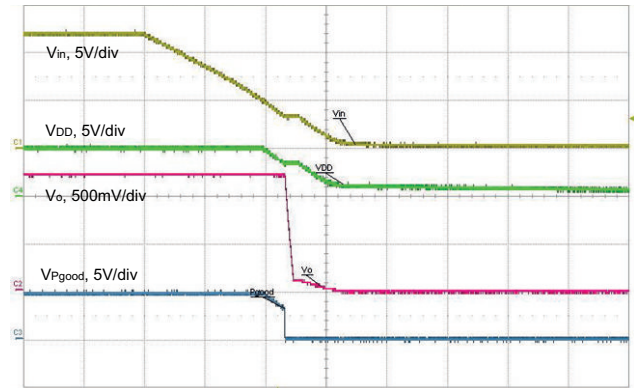

Fig. 35 - Shut down with V_{IN} , $t = 20\text{ ms/div}$

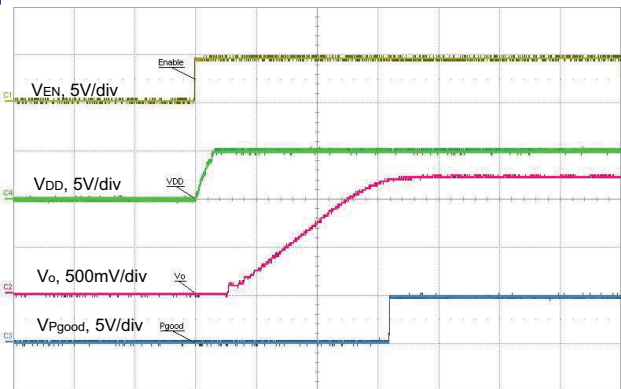

Fig. 33 - Startup with EN , $t = 1\text{ ms/div}$

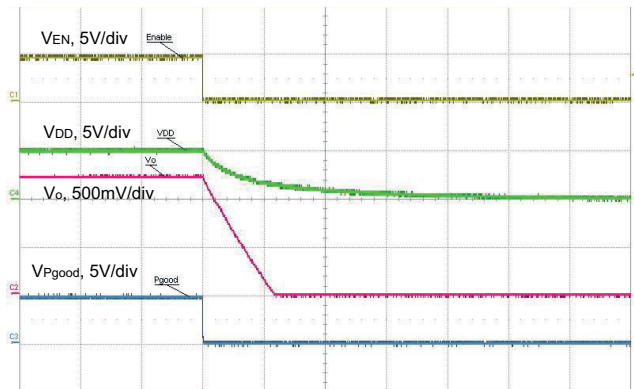

Fig. 36 - Shut down with EN , $t = 100\text{ ms/div}$

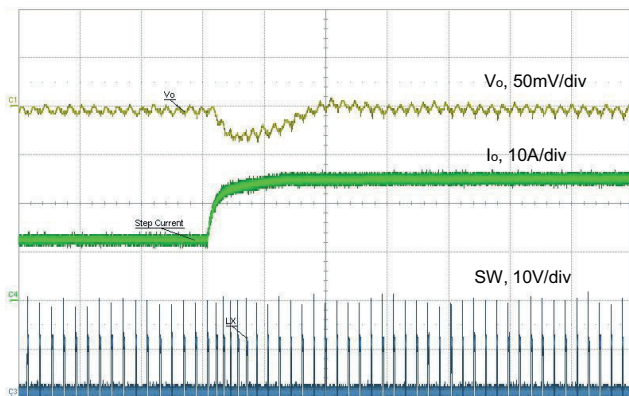

Fig. 34 - Load Step, 6 A to 12 A, 1 A/ μs , $t = 10\text{ }\mu\text{s/div}$

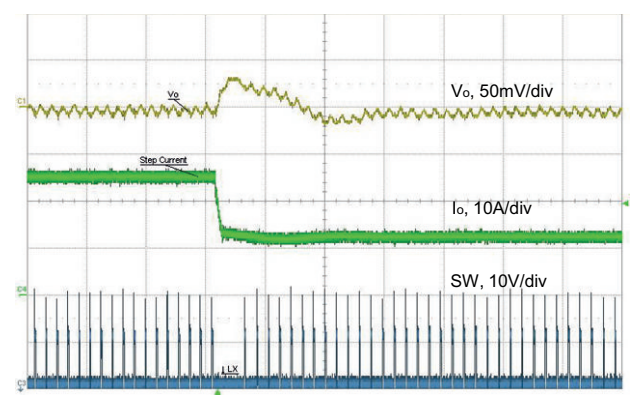
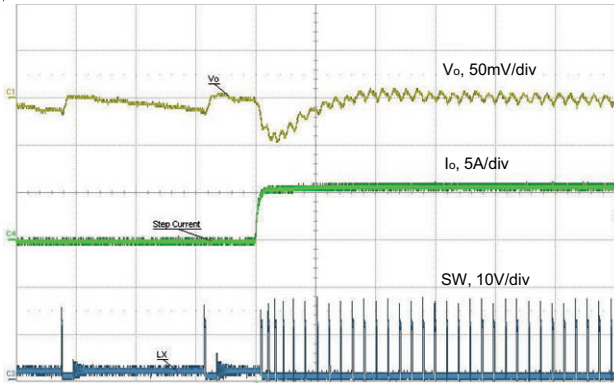

Fig. 37 - Load Release, 12 A to 6 A, 1 A/ μs , $t = 10\text{ }\mu\text{s/div}$

ELECTRICAL CHARACTERISTICS

($V_{IN} = 12\text{ V}$, $V_{OUT} = 1.2\text{ V}$, $f_{sw} = 500\text{ kHz}$, $C_{OUT} = 47\text{ }\mu\text{F} \times 7$, $C_{IN} = 10\text{ }\mu\text{F} \times 6$, unless otherwise noted)



**Fig. 38 - Load Step, 0.1 A to 6 A, 1 A/ μs , $t = 10\text{ }\mu\text{s/div}$
Skip Mode Enabled**

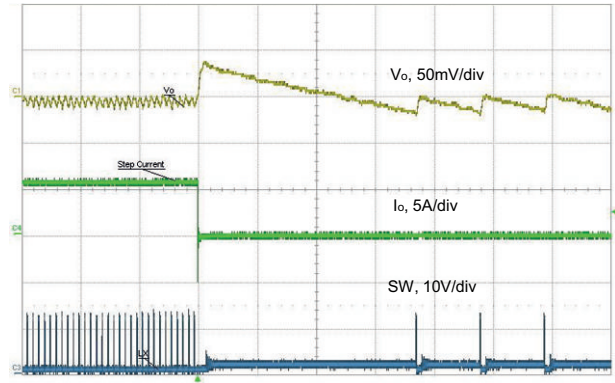

**Fig. 41 - Load Release, 6 A to 0.1 A, 1 A/ μs , $t = 20\text{ }\mu\text{s/div}$
Skip Mode Enabled**

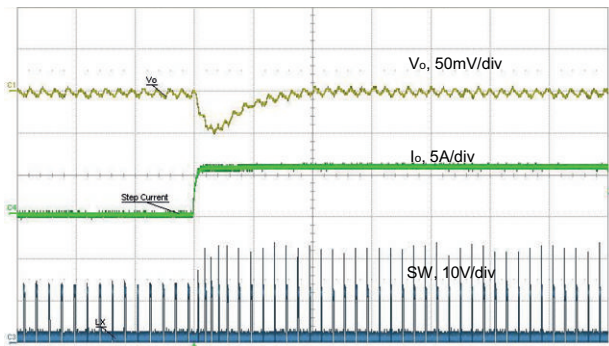

**Fig. 39 - Load Step, 0.1 A to 6 A, 1 A/ μs , $t = 10\text{ }\mu\text{s/div}$
Forced Continuous Conduction Mode**

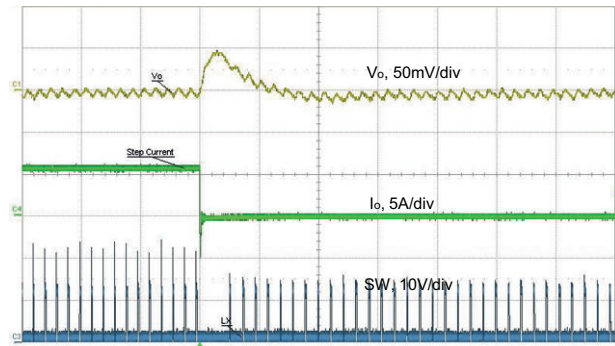

**Fig. 42 - Load Release, 6 A to 0.1 A, 1 A/ μs , $t = 10\text{ }\mu\text{s/div}$
Forced Continuous Conduction Mode**

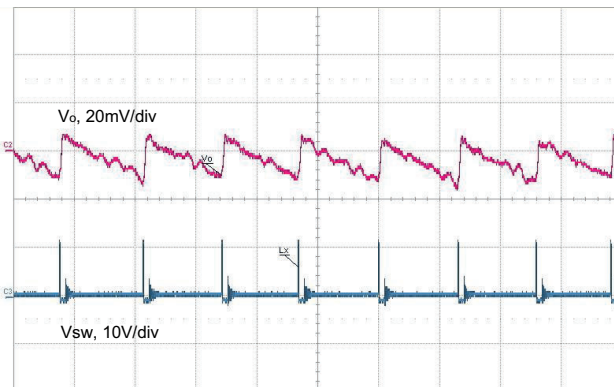

**Fig. 40 - Output Ripple, 0.1 A, $t = 20\text{ }\mu\text{s/div}$
Skip Mode Enabled**

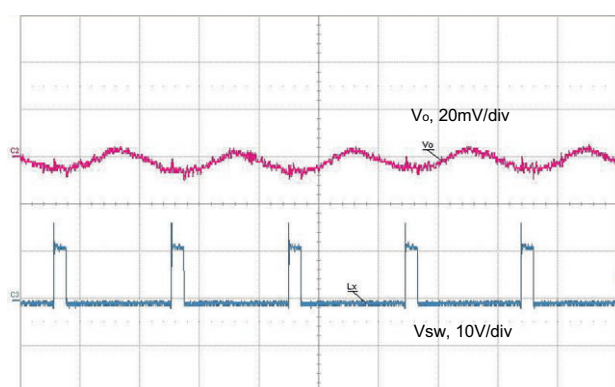

**Fig. 43 - Output Ripple, 6 A, $t = 1\text{ }\mu\text{s/div}$
Forced Continuous Conduction Mode**

ELECTRICAL CHARACTERISTICS

($V_{IN} = 12\text{ V}$, $V_{OUT} = 1.2\text{ V}$, $f_{sw} = 500\text{ kHz}$, $C_{OUT} = 47\text{ }\mu\text{F} \times 7$, $C_{IN} = 10\text{ }\mu\text{F} \times 6$, unless otherwise noted)

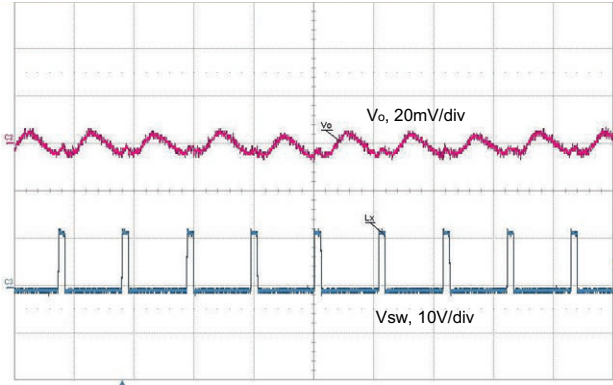

**Fig. 44 - Output Ripple, 0.1 A, $t = 2\text{ }\mu\text{s/div}$
Forced Continuous Conduction Mode**

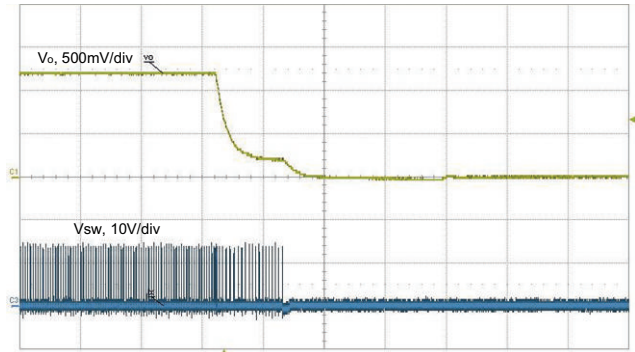

Fig. 46 - Output Undervoltage Protection Behavior, $t = 50\text{ }\mu\text{s/div}$

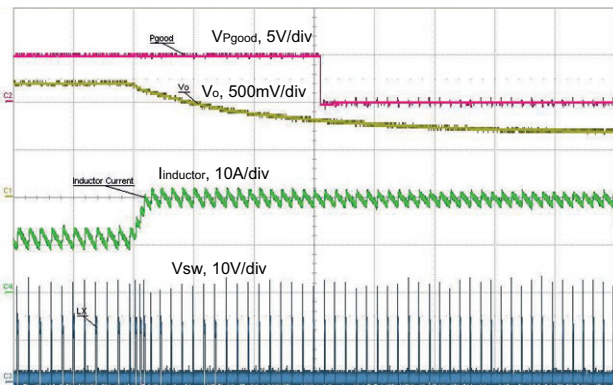

Fig. 45 - Overcurrent Protection Behavior, $t = 10\text{ }\mu\text{s/div}$

EXAMPLE SCHEMATIC

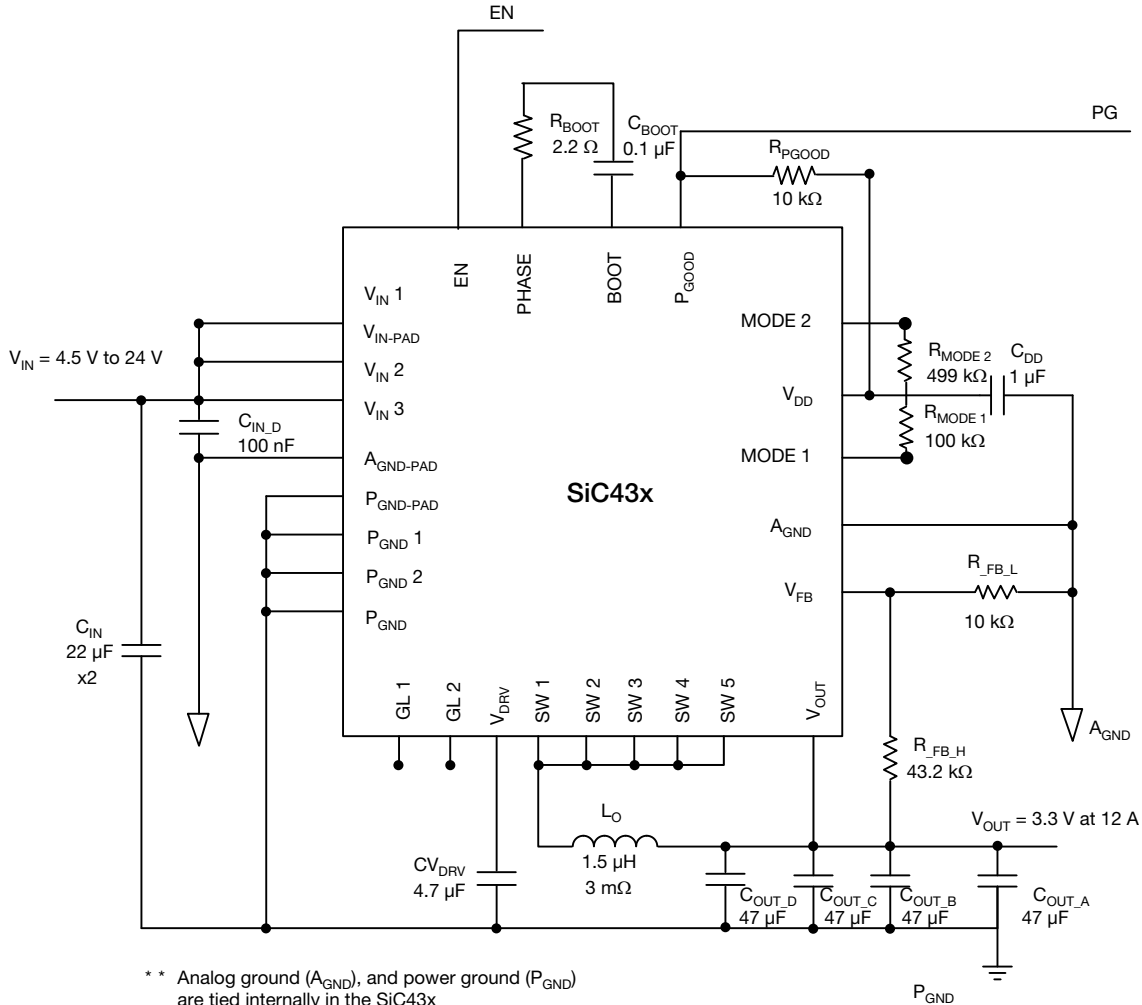

Fig. 47 - Schematic

EXTERNAL COMPONENT SELECTION FOR THE SiC43x

This section explains external component selection for the SiC43x family of regulators. Component reference designators in any equation refer to the schematic shown in Fig. 47.

The user can use the PowerCAD online design center to simplify external component calculations.

Output Voltage Adjustment

If a different output voltage is needed, simply change the value of V_{OUT} and solve for R_{FB_H} based on the following formula:

$$R_{FB_H} = \frac{R_{FB_L}(V_{OUT} - V_{FB})}{V_{FB}}$$

Where V_{FB} is 0.6 V for the SiC43x. R_{FB_L} should be a maximum of 10 k Ω to prevent V_{OUT} from drifting at no load.

Inductor Selection

The choice of inductor is specific to each application and quickly determined with the following equations:

$$t_{ON} = \frac{V_{OUT}}{V_{IN_max} \times f_{sw}}$$

and

$$L = \frac{(V_{IN} - V_{OUT}) \times t_{ON}}{I_{OUT_MAX} \times K}$$

Where K is a percentage of maximum output current ripple required. The designer can quickly make a choice of inductor if the ripple percentage is decided, usually no more than 30 % however higher or lower percentages of I_{OUT} can be acceptable depending on application. This device allows choices larger than 30 %.

Other than the inductance the DCR and saturation current parameters are key values. The DCR causes an I^2R loss which will decrease the system efficiency and generate heat. The saturation current has to be higher than the maximum output current plus $\frac{1}{2}$ of the ripple current. In an over current condition the inductor current may be very high. All this needs to be considered when selecting the inductor.

Output Capacitor Selection

The SiC43x is stable with any type of output capacitors by choosing the appropriate ripple injection components. This allows the user to choose the output capacitance based on the best trade off of board space, cost and application requirements.

The output capacitance will be determined by the ripple voltage requirement. Voltage mode COT topology can work with very small values of capacitor ESR.

The following equations are used to calculate the size needed to meet a transient load response:

$$I_{LPK} = I_{max} + 0.5 \times I_{RIPPLE_max}$$

and

$$C_{OUT_min.} = I_{LPK} \times \frac{L \times \frac{I_{LPK}^2}{V_{OUT}} - \frac{I_{max}^2}{dI_{LOAD}} \times dt}{2 \times (V_{PK} - V_{OUT})}$$

Where I_{LPK} is the peak inductor current, I_{MAX} is the maximum output current, dI_{LOAD} is the current step in μ s and V_{PK} is the peak voltage, the output voltage summed with the specified over and under shoot.

In case high ESR electrolytic capacitors are used, it is good practice to also include low ESR ceramic capacitors in parallel with the high ESR bulk capacitance to improve output ripple and transient response. A good starting point is to use a 10 μ F output capacitor.

Care must be taken to account for voltage derating of the capacitance when choosing an all ceramic output capacitance.

Enable Pin Voltage

The EN pin has an internal pull down resistor and only requires an enable voltage. This needs to be greater than 1.4 V. An input voltage or a resistor connected across V_{IN} and EN can be used. The internal pull down resistance is 5 M Ω .

Input Capacitance

In order to determine the minimum capacitance the input voltage ripple needs to be specified; $V_{CINPP} \leq 500$ mV is a suitable starting point. This magnitude is determined by the final application specification. The input current needs to be determined for the lowest operating input voltage,

$$I_{CIN(RMS)} = I_O \times \sqrt{D \times (1 - D) + \frac{1}{12} \times \left(\frac{V_{OUT}}{L \times f_{sw} \times I_{OUT}} \right)^2 \times (1 - D)^2 \times D}$$

The minimum input capacitance can then be found,

$$C_{IN_min.} = I_{OUT} \times \frac{D - (1 - D)}{V_{CINPKPK} \times f_{sw}}$$

If high ESR capacitors are used, it is good practice to also add low ESR ceramic capacitance. A 4.7 μ F ceramic input capacitance is a suitable starting point.

Care must be taken to account for voltage derating of the capacitance when choosing an all ceramic input capacitance.

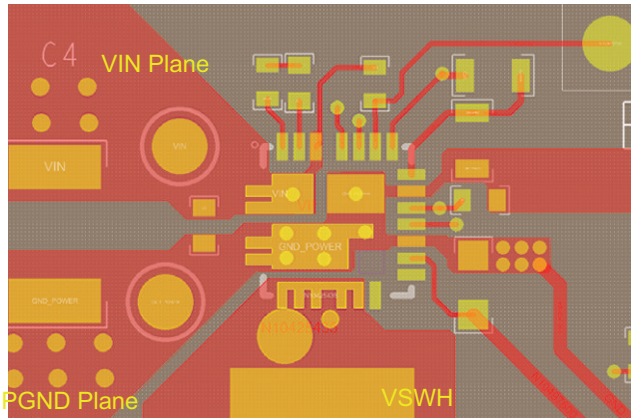
PCB LAYOUT RECOMMENDATIONS
Step 1: V_{IN} /GND Planes and Decoupling

1. Layout V_{IN} and P_{GND} planes as shown above
2. Ceramic capacitors should be placed right between V_{IN} and P_{GND} , and very close to the device for best decoupling effect
3. Different values / packages of ceramic capacitors should be used to cover entire decoupling spectrum e.g. 1210 and 0603
4. Smaller capacitance value, closer to device V_{IN} pin(s), provide better high frequency response

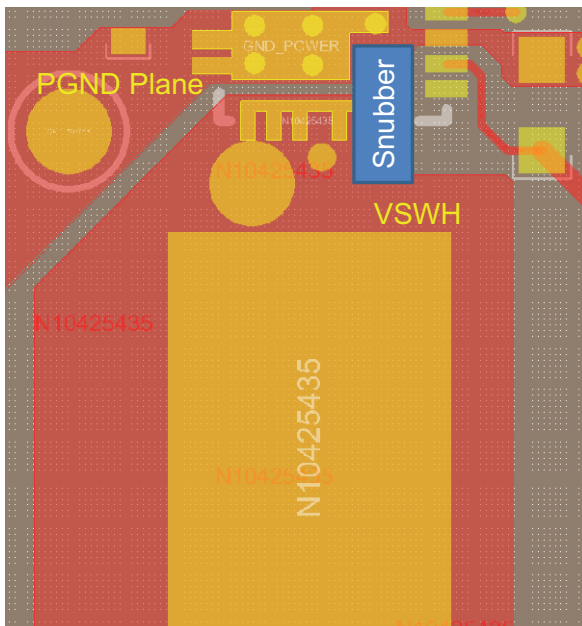
Step 2: V_{SWH} Plane

1. Connect output inductor to SiC437 and SiC438 with large plane to lower the resistance
2. If any snubber network is required, place the components on the bottom side as shown above

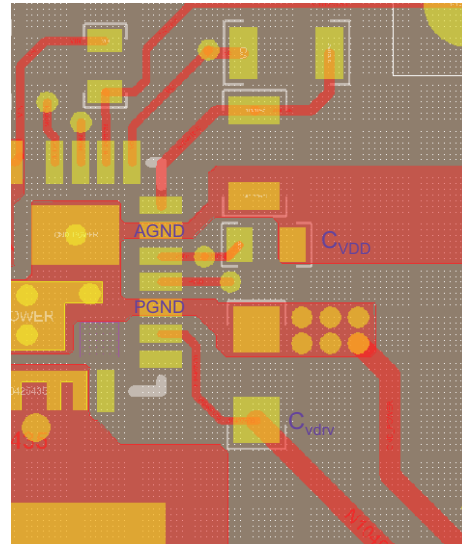
Step 3: V_{DD}/V_{DRV} Input Filter

1. C_{VDD} cap should be placed between pin 15 and pin 16 (the A_{GND} of driver IC) to achieve best noise filtering
2. C_{VDRV} cap should be placed close to V_{DRV} (pin12) and P_{GND} (pin13) to reduce effects of trace impedance and provide maximum instantaneous driver current for low side MOSFET during switching cycle

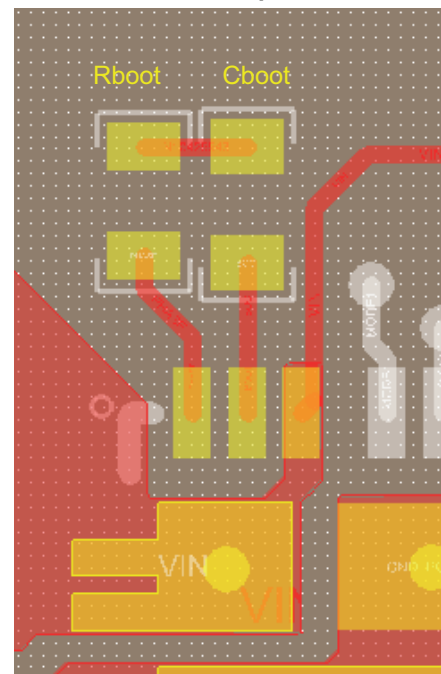
Step 4: BOOT Resistor and Capacitor Placement

1. These components need to be placed very close to SiC437 and SiC438, right between PHASE (pin 24) and BOOT (pin 23)
2. In order to reduce parasitic inductance, it is recommended to use 0402 chip size for the resistor and the capacitor.

Step 5: Signal Routing

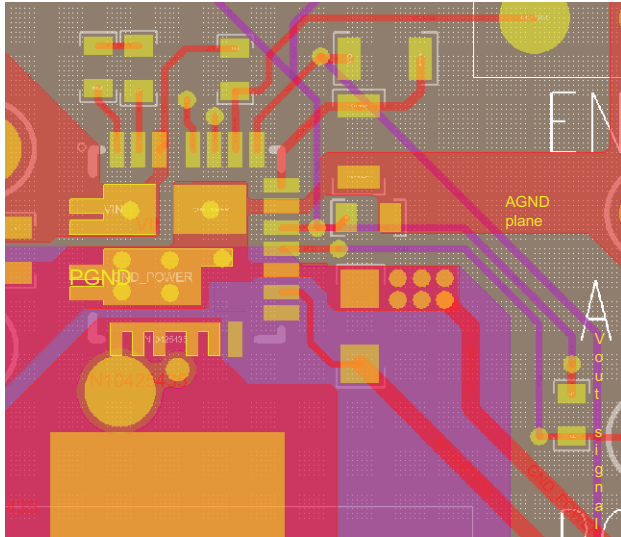

1. Separate the small analog signal from high current path. As shown above, the high paths with high dv/dt , di/dt are placed on the left side of the IC, while the small control signals are placed on the right side of the IC. All the components for small analog signal should be placed closer to IC with minimum trace length
2. Pin16 is considered as IC analog ground, which should have single connection to power ground. The A_{GND} ground plane connected with pin16 helps to keep A_{GND} quite and improve noise immunity
3. The output signal can be routed through inner layer. Make sure this signal is far away from V_{SWH} node and shielded by an inner ground layer

Step 6: Thermal Management

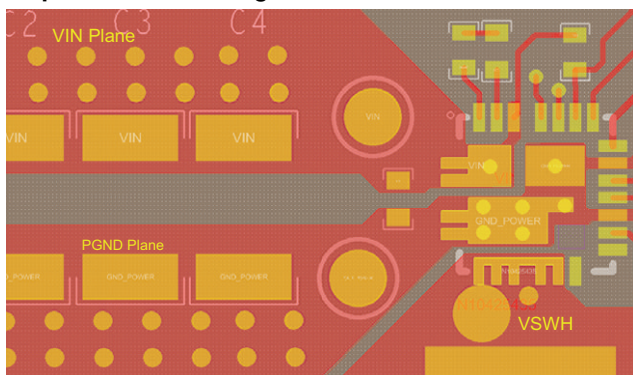

1. Thermal relief vias can be added on the V_{IN} and P_{GND} pads to utilize inner layers for high current and thermal dissipation
2. To achieve better thermal performance, additional vias can be put on V_{IN} and P_{GND} plane. It's also necessary to duplicate the V_{IN} and ground plane at bottom layer to maximize the power dissipation capability from PCB
3. V_{SWH} pad is a noise source and not recommended to put vias on this pad

4. 8 mil drill for pads and 10 mils drill for plane can be the optional via size. The vias on pad may drain solder during assembly and cause assembly issue. Please consult with the assembly house for guideline

Step 7: Ground Connection

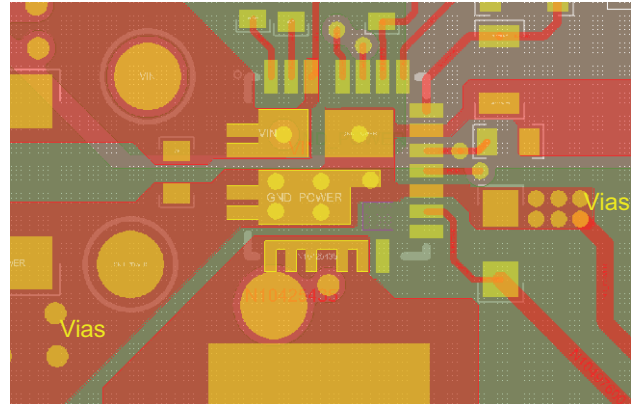

1. In order to minimize the ground voltage drop due to high current, it is recommended to put vias on the both side of the IC of the P_{GND} pin. Make use of the inner ground layers to lower the impedance

Step 7: Ground Layer

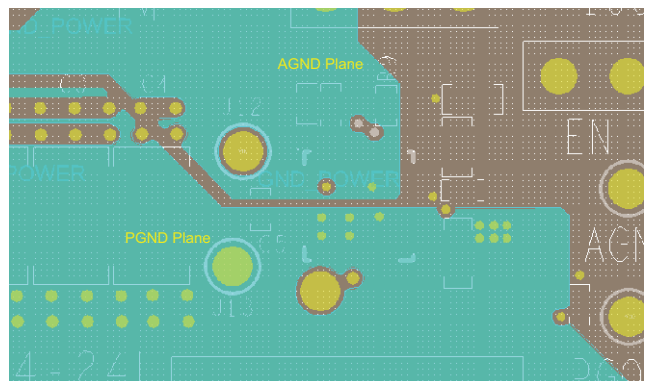

1. It is recommended to make the whole inner 1 layer (next to top layer) ground plane
2. This ground plane provides shielding between noise source on top layer and signal trace within inner layer
3. The Ground plane can be broken into two section as P_{GND} and A_{GND}



PACKAGE OUTLINE DRAWING PowerPAK® MLP44-24L

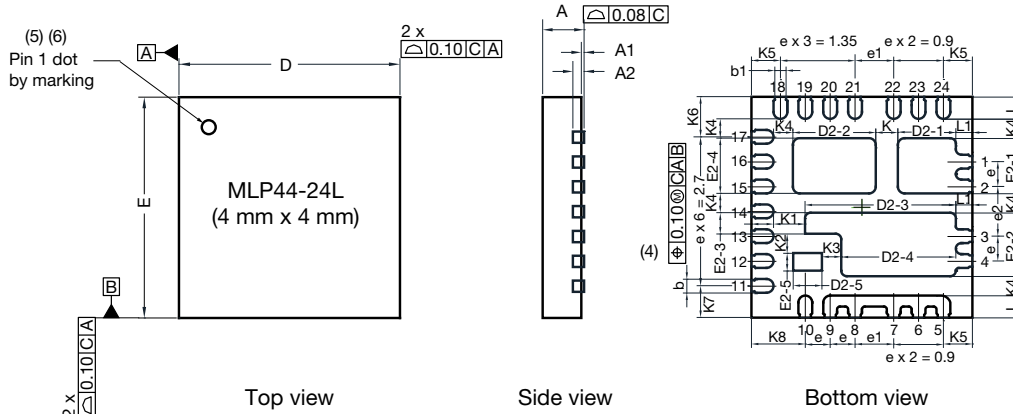

DIM.	MILLIMETERS			INCHES		
	MIN.	NOM.	MAX.	MIN.	NOM.	MAX.
A ⁽⁶⁾	0.70	0.75	0.80	0.027	0.029	0.031
A1	0.00	-	0.05	0.000	-	0.002
A2	0.20 ref.			0.008 ref.		
b ⁽⁴⁾	0.20	0.25	0.30	0.008	0.010	0.012
b1	0.15	0.20	0.25	0.006	0.008	0.010
D	3.90	4.00	4.10	0.155	0.157	0.159
e	0.45 BSC			0.018 BSC		
e1	0.70 BSC			0.028 BSC		
e2	0.90 BSC			0.035 BSC		
E	3.90	4.00	4.10	0.155	0.157	0.159
L	0.35	0.40	0.45	0.014	0.016	0.018
N ⁽³⁾	24			24		
D2-1	1.00	1.05	1.10	0.039	0.041	0.043
D2-2	1.45	1.50	1.55	0.057	0.059	0.061
D2-3	2.68	2.73	2.78	0.106	0.108	0.110
D2-4	2.02	2.07	2.12	0.079	0.081	0.083
D2-5	0.47	0.52	0.57	0.018	0.020	0.022
E2-1	0.95	1.00	1.05	0.037	0.039	0.041
E2-2	1.10	1.15	1.20	0.043	0.045	0.047
E2-3	0.33	0.38	0.43	0.013	0.015	0.017
E2-4	0.95	1.00	1.05	0.037	0.039	0.041
E2-5	0.27	0.32	0.37	0.011	0.013	0.015
K	0.40 ref.			0.016 ref.		
K1	0.57 ref.			0.022 ref.		
K2	0.35 ref.			0.014 ref.		
K3	0.35 ref.			0.014 ref.		
K4	0.35 ref.			0.014 ref.		
K5	0.525 ref.			0.021 ref.		
K6	0.725 ref.			0.029 ref.		
K7	0.575 ref.			0.023 ref.		
K8	0.975 ref.			0.038 ref.		

Notes

- (1) Use millimeters as the primary measurement
- (2) Dimensioning and tolerances conform to ASME Y14.5M. - 1994
- (3) N is the number of terminals
- (4) Dimension b applies to plated terminal and is measured between 0.20 mm and 0.25 mm from terminal tip
- (5) The pin #1 identifier must be existed on the top surface of the package by using indentation mark or other feature of package body
- (6) Exact shape and size of this feature is optional
- (7) Package warpage max. 0.08 mm
- (8) Applied only for terminals



PRODUCT SUMMARY				
Part number	SiC437A	SiC437B	SiC437C	SiC437D
Description	12 A, 4.5 V to 28 V input, 300 kHz, 500 kHz, 750 kHz, 1 MHz, Synchronous Buck Regulator with Ultrasonic Mode and Internal 5 V Bias	12 A, 4.5 V to 28 V input, 300 kHz, 500 kHz, 750 kHz, 1 MHz, Synchronous Buck Regulator with Power Save Mode and Internal 5 V Bias	12 A, 3 V to 28 V input, 300 kHz, 500 kHz, 750 kHz, 1 MHz, Synchronous Buck Regulator with Ultrasonic Mode, requires external 5 V Bias	12 A, 3 V to 28 V input, 300 kHz, 500 kHz, 750 kHz, 1 MHz, Synchronous Buck Regulator with Power Save Mode, requires external 5 V Bias
Input voltage min. (V)	4.5	4.5	3	3
Input voltage max. (V)	28	28	28	28
Output voltage min. (V)	0.6	0.6	0.6	0.6
Output voltage max. (V)	0.9 x V _{IN}	0.9 x V _{IN}	0.9 x V _{IN}	0.9 x V _{IN}
Continuous current (A)	12	12	12	12
Switch frequency min. (kHz)	300	300	300	300
Switch frequency max. (kHz)	1000	1000	1000	1000
Pre-bias operation (yes / no)	Yes	Yes	Yes	Yes
Internal bias reg. (yes / no)	Yes	Yes	No	No
Compensation	Internal	Internal	Internal	Internal
Enable (yes / no)	Yes	Yes	Yes	Yes
P _{GOOD} (yes / no)	Yes	Yes	Yes	Yes
Over current protection	Yes	Yes	Yes	Yes
Protection	OVP, OCP, UVP/SCP, OTP, UVLO	OVP, OCP, UVP/SCP, OTP, UVLO	OVP, OCP, UVP/SCP, OTP, UVLO	OVP, OCP, UVP/SCP, OTP, UVLO
Light load mode	Selectable ultrasonic	Selectable powersave	Selectable ultrasonic	Selectable powersave
Peak efficiency (%)	97	97	97	97
Package type	PowerPAK MLP44-24L	PowerPAK MLP44-24L	PowerPAK MLP44-24L	PowerPAK MLP44-24L
Package size (W, L, H) (mm)	4 x 4 x 0.75	4 x 4 x 0.75	4 x 4 x 0.75	4 x 4 x 0.75
Status code	1	1	1	1
Product type	microBUCK (step down regulator)	microBUCK (step down regulator)	microBUCK (step down regulator)	microBUCK (step down regulator)
Applications	Computing, consumer, industrial, healthcare, networking	Computing, consumer, industrial, healthcare, networking	Computing, consumer, industrial, healthcare, networking	Computing, consumer, industrial, healthcare, networking



PRODUCT SUMMARY				
Part number	SiC438A	SiC438B	SiC438C	SiC438D
Description	8 A, 4.5 V to 28 V input, 300 kHz, 500 kHz, 750 kHz, 1 MHz, Synchronous Buck Regulator with Ultrasonic Mode and Internal 5 V Bias	8 A, 4.5 V to 28 V input, 300 kHz, 500 kHz, 750 kHz, 1 MHz, Synchronous Buck Regulator with Power Save Mode and Internal 5 V Bias	8 A, 3 V to 28 V input, 300 kHz, 500 kHz, 750 kHz, 1 MHz, Synchronous Buck Regulator with Ultrasonic Mode, requires external 5 V Bias	8 A, 3 V to 28 V input, 300 kHz, 500 kHz, 750 kHz, 1 MHz, Synchronous Buck Regulator with Power Save Mode, requires external 5 V Bias
Input voltage min. (V)	4.5	4.5	3	3
Input voltage max. (V)	28	28	28	28
Output voltage min. (V)	0.6	0.6	0.6	0.6
Output voltage max. (V)	0.9 x V _{IN}	0.9 x V _{IN}	0.9 x V _{IN}	0.9 x V _{IN}
Continuous current (A)	8	8	8	8
Switch frequency min. (kHz)	300	300	300	300
Switch frequency max. (kHz)	1000	1000	1000	1000
Pre-bias operation (yes / no)	Yes	Yes	Yes	Yes
Internal bias reg. (yes / no)	Yes	Yes	No	No
Compensation	Internal	Internal	Internal	Internal
Enable (yes / no)	Yes	Yes	Yes	Yes
P _{GOOD} (yes / no)	Yes	Yes	Yes	Yes
Over current protection	Yes	Yes	Yes	Yes
Protection	OVP, OCP, UVP/SCP, OTP, UVLO	OVP, OCP, UVP/SCP, OTP, UVLO	OVP, OCP, UVP/SCP, OTP, UVLO	OVP, OCP, UVP/SCP, OTP, UVLO
Light load mode	Selectable ultrasonic	Selectable powersave	Selectable ultrasonic	Selectable powersave
Peak efficiency (%)	97	97	97	97
Package type	PowerPAK MLP44-24L	PowerPAK MLP44-24L	PowerPAK MLP44-24L	PowerPAK MLP44-24L
Package size (W, L, H) (mm)	4 x 4 x 0.75	4 x 4 x 0.75	4 x 4 x 0.75	4 x 4 x 0.75
Status code	1	1	1	1
Product type	microBUCK (step down regulator)	microBUCK (step down regulator)	microBUCK (step down regulator)	microBUCK (step down regulator)
Applications	Computing, consumer, industrial, healthcare, networking	Computing, consumer, industrial, healthcare, networking	Computing, consumer, industrial, healthcare, networking	Computing, consumer, industrial, healthcare, networking

Vishay Siliconix maintains worldwide manufacturing capability. Products may be manufactured at one of several qualified locations. Reliability data for Silicon Technology and Package Reliability represent a composite of all qualified locations. For related documents such as package / tape drawings, part marking, and reliability data, see www.vishay.com/ppg?75921.

PowerPAK® MLP44-24L Case Outline

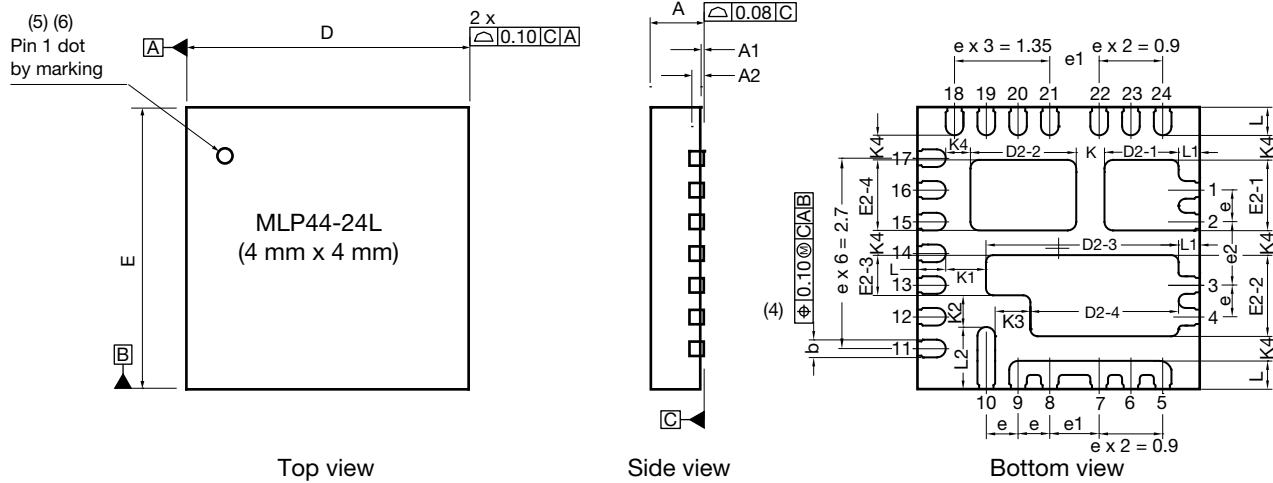

DIM.	MILLIMETERS			INCHES		
	MIN.	NOM.	MAX.	MIN.	NOM.	MAX.
A ⁽⁸⁾	0.70	0.75	0.80	0.027	0.029	0.031
A1	0.00	-	0.05	0.000	-	0.002
A2	0.20 ref.			0.008 ref.		
b ⁽⁴⁾	0.20	0.25	0.30	0.078	0.098	0.110
D	3.90	4.00	4.10	0.155	0.157	0.159
e	0.45 BSC			0.018 BSC		
e1	0.70 BSC			0.028 BSC		
e2	0.90 BSC			0.035 BSC		
E	3.90	4.00	4.10	0.155	0.157	0.159
L	0.35	0.40	0.45	0.014	0.016	0.018
L1	0.25	0.30	0.35	0.010	0.012	0.014
L2	0.83	0.88	0.93	0.033	0.035	0.037
N ⁽³⁾	24			24		
D2-1	1.00	1.05	1.10	0.039	0.041	0.043
D2-2	1.45	1.50	1.55	0.057	0.059	0.061
D2-3	2.68	2.73	2.78	0.106	0.108	0.110
D2-4	2.05	2.10	2.15	0.081	0.083	0.085
E2-1	0.95	1.00	1.05	0.037	0.039	0.041
E2-2	1.10	1.15	1.20	0.043	0.045	0.047
E2-3	0.52	0.57	0.62	0.020	0.022	0.024
E2-4	0.95	1.00	1.05	0.037	0.039	0.041
K	0.40 ref.			0.016 ref.		
K1	0.57 ref.			0.022 ref.		
K2	0.45 ref.			0.018 ref.		
K3	0.50 ref.			0.020 ref.		
K4	0.35 ref.			0.014 ref.		

ECN: T16-0945-Rev. A, 19-Dec-16
DWG: 6055

Notes

- (1) Use millimeters as the primary measurement
- (2) Dimensioning and tolerances conform to ASME Y14.5M. - 1994
- (3) N is the number of terminals
- (4) Dimension b applies to plated terminal and is measured between 0.20 mm and 0.25 mm from terminal tip
- (5) The pin #1 identifier must be existed on the top surface of the package by using indentation mark or other feature of package body
- (6) Exact shape and size of this feature is optional
- (7) Package warpage max. 0.08 mm
- (8) Applied only for terminals

Recommended Land Pattern PowerPAK® MLP44-24L

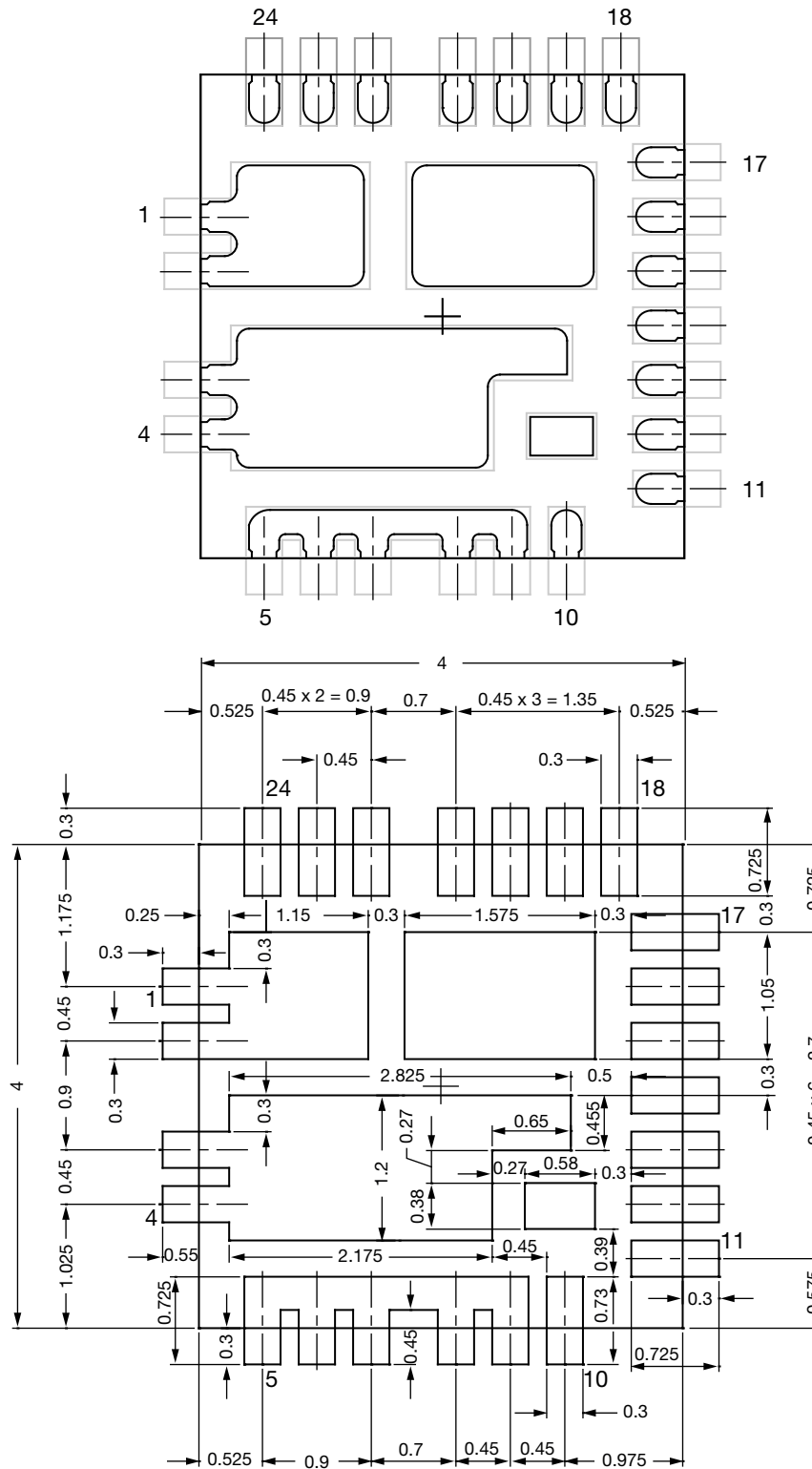

All dimensions are in millimeters



Disclaimer

ALL PRODUCT, PRODUCT SPECIFICATIONS AND DATA ARE SUBJECT TO CHANGE WITHOUT NOTICE TO IMPROVE RELIABILITY, FUNCTION OR DESIGN OR OTHERWISE.

Vishay Intertechnology, Inc., its affiliates, agents, and employees, and all persons acting on its or their behalf (collectively, "Vishay"), disclaim any and all liability for any errors, inaccuracies or incompleteness contained in any datasheet or in any other disclosure relating to any product.

Vishay makes no warranty, representation or guarantee regarding the suitability of the products for any particular purpose or the continuing production of any product. To the maximum extent permitted by applicable law, Vishay disclaims (i) any and all liability arising out of the application or use of any product, (ii) any and all liability, including without limitation special, consequential or incidental damages, and (iii) any and all implied warranties, including warranties of fitness for particular purpose, non-infringement and merchantability.

Statements regarding the suitability of products for certain types of applications are based on Vishay's knowledge of typical requirements that are often placed on Vishay products in generic applications. Such statements are not binding statements about the suitability of products for a particular application. It is the customer's responsibility to validate that a particular product with the properties described in the product specification is suitable for use in a particular application. Parameters provided in datasheets and / or specifications may vary in different applications and performance may vary over time. All operating parameters, including typical parameters, must be validated for each customer application by the customer's technical experts. Product specifications do not expand or otherwise modify Vishay's terms and conditions of purchase, including but not limited to the warranty expressed therein.

Except as expressly indicated in writing, Vishay products are not designed for use in medical, life-saving, or life-sustaining applications or for any other application in which the failure of the Vishay product could result in personal injury or death. Customers using or selling Vishay products not expressly indicated for use in such applications do so at their own risk. Please contact authorized Vishay personnel to obtain written terms and conditions regarding products designed for such applications.

No license, express or implied, by estoppel or otherwise, to any intellectual property rights is granted by this document or by any conduct of Vishay. Product names and markings noted herein may be trademarks of their respective owners.