

---

# R1LV1616H-I Series

Wide Temperature Range Version

16 M SRAM (1-Mword  $\times$  16-bit / 2-Mword  $\times$  8-bit)

REJ03C0195-0101

Rev.1.01

Nov.18.2004

---

## Description

The R1LV1616H-I Series is 16-Mbit static RAM organized 1-Mword  $\times$  16-bit / 2-Mword  $\times$  8-bit. R1LV1616H-I Series has realized higher density, higher performance and low power consumption by employing CMOS process technology (6-transistor memory cell). It offers low power standby power dissipation; therefore, it is suitable for battery backup systems. It is packaged in 48-pin plastic TSOPI for high density surface mounting.

## Features

- Single 3.0 V supply: 2.7 V to 3.6 V
- Fast access time: 45/55 ns (max)
- Power dissipation:
  - Active: 9 mW/MHz (typ)
  - Standby: 1.5  $\mu$ W (typ)
- Completely static memory.
  - No clock or timing strobe required
- Equal access and cycle times
- Common data input and output.
  - Three state output
- Battery backup operation.
  - 2 chip selection for battery backup
- Temperature range:  $-40$  to  $+85^{\circ}\text{C}$
- Byte function ( $\times 8$  mode) available by BYTE# & A-1.

## R1LV1616H-I Series

---

### Ordering Information

Type No.	Access time	Package
R1LV1616HSA-4LI	45 ns	48-pin plastic TSOPI (48P3R-B)
R1LV1616HSA-4SI	45 ns	
R1LV1616HSA-5SI	55 ns	

Pin Arrangement

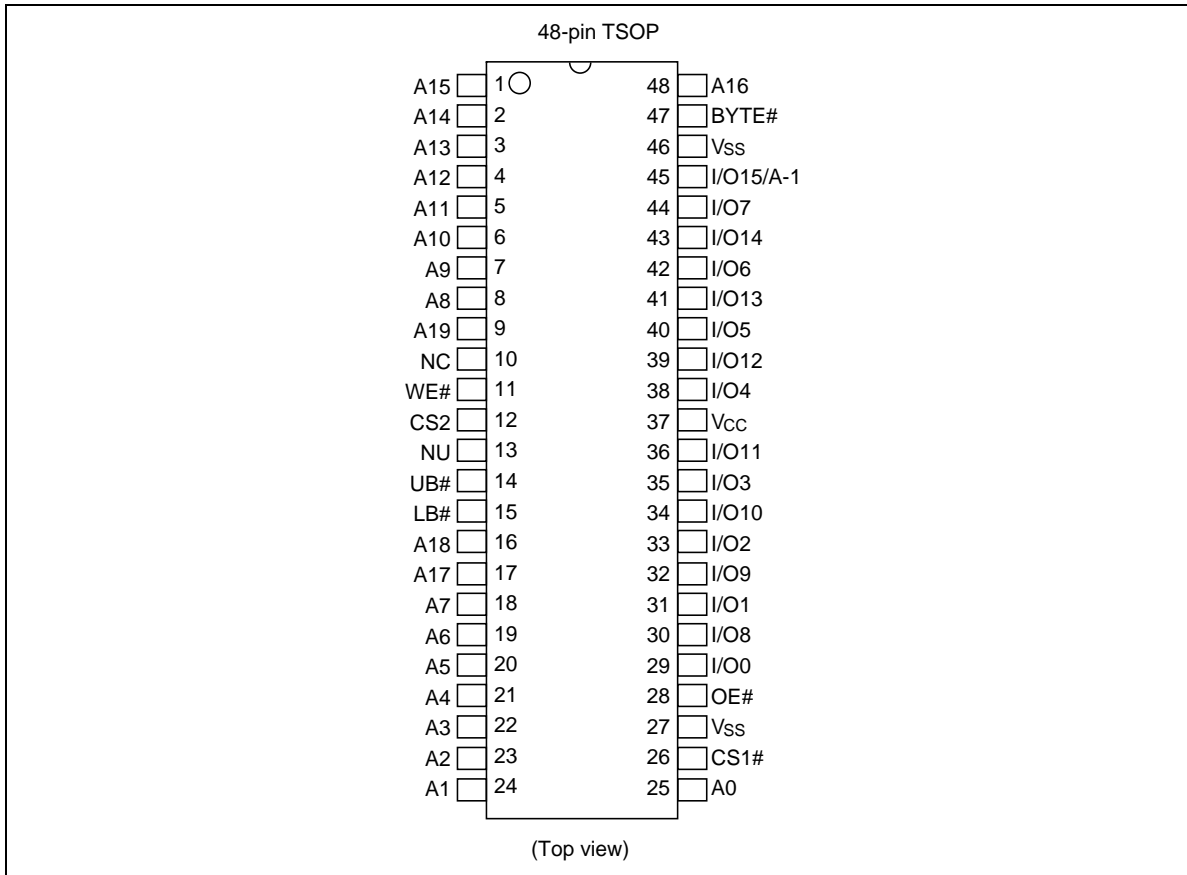

**Pin Description (TSOP)**

<b>Pin name</b>	<b>Function</b>
A0 to A19	Address input (word mode)
A-1 to A19	Address input (byte mode)
I/O0 to I/O15	Data input/output
CS1# ( $\overline{\text{CS1}}$ )	Chip select 1
CS2	Chip select 2
WE# ( $\overline{\text{WE}}$ )	Write enable
OE# ( $\overline{\text{OE}}$ )	Output enable
LB# ( $\overline{\text{LB}}$ )	Lower byte select
UB# ( $\overline{\text{UB}}$ )	Upper byte select
BYTE# ( $\overline{\text{BYTE}}$ )	Byte enable
V <sub>CC</sub>	Power supply
V <sub>SS</sub>	Ground
NC	No connection
NU* <sup>1</sup>	Not used (test mode pin)

Note: 1. This pin should be connected to a ground (V<sub>SS</sub>), or not be connected (open).

Block Diagram (TSOP)

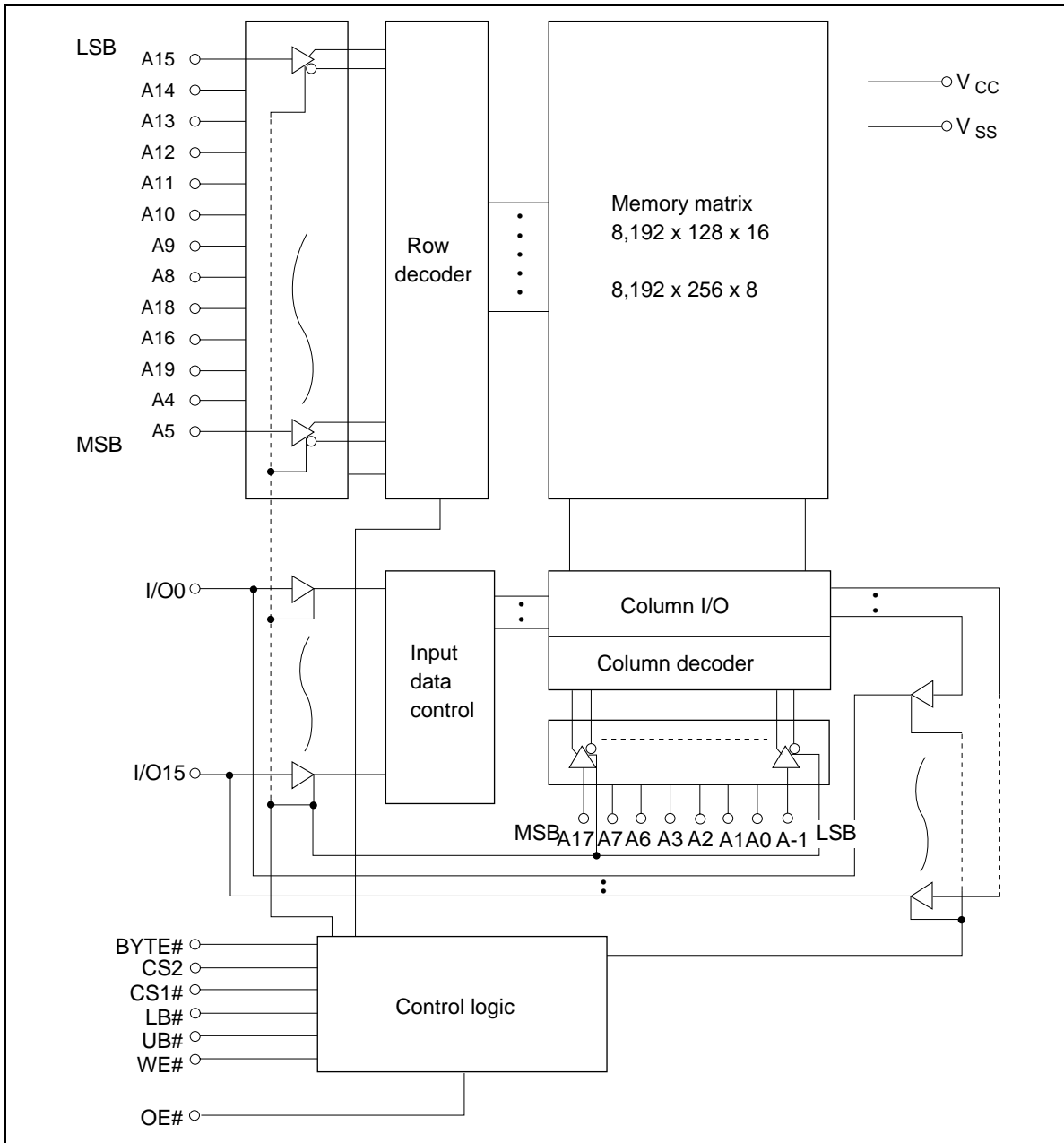

## Operation Table (TSOP)

### Byte mode

CS1#	CS2	WE#	OE#	UB#	LB#	BYTE#	I/O0 to I/O7	I/O8 to I/O14	I/O15	Operation
H	x	x	x	x	x	L	High-Z	High-Z	High-Z	Standby
x	L	x	x	x	x	L	High-Z	High-Z	High-Z	Standby
L	H	H	L	x	x	L	Dout	High-Z	A-1	Read
L	H	L	x	x	x	L	Din	High-Z	A-1	Write
L	H	H	H	x	x	L	High-Z	High-Z	High-Z	Output disable

Note: H:  $V_{IH}$ , L:  $V_{IL}$ , x:  $V_{IH}$  or  $V_{IL}$

### Word mode

CS1#	CS2	WE#	OE#	UB#	LB#	BYTE#	I/O0 to I/O7	I/O8 to I/O14	I/O15	Operation
H	x	x	x	x	x	H	High-Z	High-Z	High-Z	Standby
x	L	x	x	x	x	H	High-Z	High-Z	High-Z	Standby
x	x	x	x	H	H	H	High-Z	High-Z	High-Z	Standby
L	H	H	L	L	L	H	Dout	Dout	Dout	Read
L	H	H	L	H	L	H	Dout	High-Z	High-Z	Lower byte read
L	H	H	L	L	H	H	High-Z	Dout	Dout	Upper byte read
L	H	L	x	L	L	H	Din	Din	Din	Write
L	H	L	x	H	L	H	Din	High-Z	High-Z	Lower byte write
L	H	L	x	L	H	H	High-Z	Din	Din	Upper byte write
L	H	H	H	x	x	H	High-Z	High-Z	High-Z	Output disable

Note: H:  $V_{IH}$ , L:  $V_{IL}$ , x:  $V_{IH}$  or  $V_{IL}$

**Absolute Maximum Ratings**

Parameter	Symbol	Value	Unit
Power supply voltage relative to $V_{SS}$	$V_{CC}$	-0.5 to +4.6	V
Terminal voltage on any pin relative to $V_{SS}$	$V_T$	-0.5* <sup>1</sup> to $V_{CC} + 0.3$ * <sup>2</sup>	V
Power dissipation	$P_T$	1.0	W
Storage temperature range	Tstg	-55 to +125	°C
Storage temperature range under bias	Tbias	-40 to +85	°C

Notes: 1.  $V_T$  min: -2.0 V for pulse half-width  $\leq 10$  ns.  
2. Maximum voltage is +4.6 V.

**DC Operating Conditions**

Parameter	Symbol	Min	Typ	Max	Unit	Note
Supply voltage	$V_{CC}$	2.7	3.0	3.6	V	
	$V_{SS}$	0	0	0	V	
Input high voltage	$V_{IH}$	2.2	—	$V_{CC} + 0.3$	V	
Input low voltage	$V_{IL}$	-0.3	—	0.6	V	1
Ambient temperature range	Ta	-40	—	+85	°C	

Note: 1.  $V_{IL}$  min: -2.0 V for pulse half-width  $\leq 10$  ns.

**DC Characteristics**

Parameter	Symbol	Min	Typ	Max	Unit	Test conditions*2	
Input leakage current	$ I_{LI} $	—	—	1	$\mu\text{A}$	$V_{in} = V_{SS}$ to $V_{CC}$	
Output leakage current	$ I_{LO} $	—	—	1	$\mu\text{A}$	CS1# = $V_{IH}$ or CS2 = $V_{IL}$ or OE# = $V_{IH}$ or WE# = $V_{IL}$ or LB# = UB# = $V_{IH}$ , $V_{I/O} = V_{SS}$ to $V_{CC}$	
Operating current	$I_{CC}$	—	—	20	mA	CS1# = $V_{IL}$ , CS2 = $V_{IH}$ , Others = $V_{IH}/V_{IL}$ , $I_{I/O} = 0$ mA	
Average operating current	$I_{CC1}$ (READ)	—	22*1	35	mA	Min. cycle, duty = 100%, $I_{I/O} = 0$ mA, CS1# = $V_{IL}$ , CS2 = $V_{IH}$ , WE# = $V_{IH}$ , Others = $V_{IH}/V_{IL}$	
	$I_{CC1}$	—	30*1	50	mA	Min. cycle, duty = 100%, $I_{I/O} = 0$ mA, CS1# = $V_{IL}$ , CS2 = $V_{IH}$ , Others = $V_{IH}/V_{IL}$	
	$I_{CC2}$ *3 (READ)	—	3*1	8	mA	Cycle time = 70 ns, duty = 100%, $I_{I/O} = 0$ mA, CS1# = $V_{IL}$ , CS2 = $V_{IH}$ , WE# = $V_{IH}$ , Others = $V_{IH}/V_{IL}$ Address increment scan or decrement scan	
	$I_{CC2}$ *3	—	20*1	30	mA	Cycle time = 70 ns, duty = 100%, $I_{I/O} = 0$ mA, CS1# = $V_{IL}$ , CS2 = $V_{IH}$ , Others = $V_{IH}/V_{IL}$ Address increment scan or decrement scan	
	$I_{CC3}$	—	3*1	8	mA	Cycle time = 1 $\mu\text{s}$ , duty = 100%, $I_{I/O} = 0$ mA, CS1# $\leq 0.2$ V, CS2 $\geq V_{CC} - 0.2$ V $V_{IH} \geq V_{CC} - 0.2$ V, $V_{IL} \leq 0.2$ V	
Standby current	$I_{SB}$	—	0.1*1	0.5	mA	CS2 = $V_{IL}$	
Standby current	-4SI -5SI	$I_{SB1}$	—	0.5*1	8	$\mu\text{A}$	$0 \text{ V} \leq V_{in}$ (1) $0 \text{ V} \leq \text{CS2} \leq 0.2 \text{ V}$ or (2) CS1# $\geq V_{CC} - 0.2 \text{ V}$ , CS2 $\geq V_{CC} - 0.2 \text{ V}$ or (3) LB# = UB# $\geq V_{CC} - 0.2 \text{ V}$ , CS2 $\geq V_{CC} - 0.2 \text{ V}$ , CS1# $\leq 0.2 \text{ V}$ Average value
	-4LI	$I_{SB1}$	—	0.5*1	25	$\mu\text{A}$	
Output high voltage	$V_{OH}$	2.4	—	—	V	$I_{OH} = -1$ mA	
	$V_{OH}$	$V_{CC} - 0.2$	—	—	V	$I_{OH} = -100$ $\mu\text{A}$	
Output low voltage	$V_{OL}$	—	—	0.4	V	$I_{OL} = 2$ mA	
	$V_{OL}$	—	—	0.2	V	$I_{OL} = 100$ $\mu\text{A}$	



## R1LV1616H-I Series

---

- Notes: 1. Typical values are at  $V_{CC} = 3.0\text{ V}$ ,  $T_a = +25^\circ\text{C}$  and not guaranteed.  
2.  $\text{BYTE}\# \geq V_{CC} - 0.2\text{ V}$  or  $\text{BYTE}\# \leq 0.2\text{ V}$   
3.  $I_{CC2}$  is the value measured while the valid address is increasing or decreasing by one bit.  
Word mode: LSB (least significant bit) is A0.  
Byte mode: LSB (least significant bit) is A-1.

## Capacitance

( $T_a = +25^\circ\text{C}$ ,  $f = 1.0\text{ MHz}$ )

Parameter	Symbol	Min	Typ	Max	Unit	Test conditions	Note
Input capacitance	$C_{in}$	—	—	8	pF	$V_{in} = 0\text{ V}$	1
Input/output capacitance	$C_{I/O}$	—	—	10	pF	$V_{I/O} = 0\text{ V}$	1

Note: 1. This parameter is sampled and not 100% tested.

## AC Characteristics

( $T_a = -40$  to  $+85^\circ\text{C}$ ,  $V_{CC} = 2.7$  V to  $3.6$  V, unless otherwise noted.)

### Test Conditions

- Input pulse levels:  $V_{IL} = 0.4$  V,  $V_{IH} = 2.4$  V
- Input rise and fall time: 5 ns
- Input and output timing reference levels: 1.4 V
- Output load: See figures (Including scope and jig)

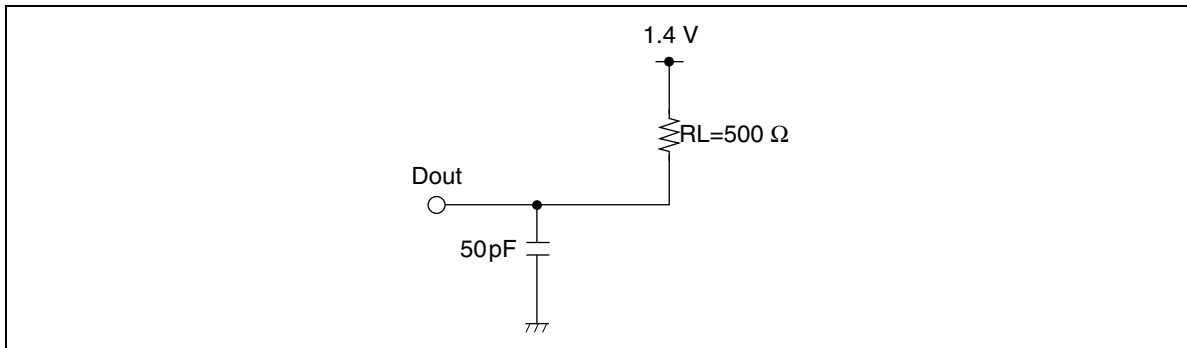

## R1LV1616H-I Series

### Read Cycle

Parameter	Symbol	R1LV1616H-I				Unit	Notes
		-4SI, -4LI		-5SI			
		Min	Max	Min	Max		
Read cycle time	$t_{RC}$	45	—	55	—	ns	
Address access time	$t_{AA}$	—	45	—	55	ns	
Chip select access time	$t_{ACS1}$	—	45	—	55	ns	
	$t_{ACS2}$	—	45	—	55	ns	
Output enable to output valid	$t_{OE}$	—	30	—	35	ns	
Output hold from address change	$t_{OH}$	10	—	10	—	ns	
LB#, UB# access time	$t_{BA}$	—	45	—	55	ns	
Chip select to output in low-Z	$t_{CLZ1}$	10	—	10	—	ns	2, 3
	$t_{CLZ2}$	10	—	10	—	ns	2, 3
LB#, UB# enable to low-Z	$t_{BLZ}$	5	—	5	—	ns	2, 3
Output enable to output in low-Z	$t_{OLZ}$	5	—	5	—	ns	2, 3
Chip deselect to output in high-Z	$t_{CHZ1}$	0	20	0	20	ns	1, 2, 3
	$t_{CHZ2}$	0	20	0	20	ns	1, 2, 3
LB#, UB# disable to high-Z	$t_{BHZ}$	0	15	0	20	ns	1, 2, 3
Output disable to output in high-Z	$t_{OHZ}$	0	15	0	20	ns	1, 2, 3

### Write Cycle

Parameter	Symbol	R1LV1616H-I				Unit	Notes
		-4SI, -4LI		-5SI			
		Min	Max	Min	Max		
Write cycle time	$t_{WC}$	45	—	55	—	ns	
Address valid to end of write	$t_{AW}$	45	—	50	—	ns	
Chip selection to end of write	$t_{CW}$	45	—	50	—	ns	5
Write pulse width	$t_{WP}$	35	—	40	—	ns	4
LB#, UB# valid to end of write	$t_{BW}$	45	—	50	—	ns	
Address setup time	$t_{AS}$	0	—	0	—	ns	6
Write recovery time	$t_{WR}$	0	—	0	—	ns	7
Data to write time overlap	$t_{DW}$	25	—	25	—	ns	
Data hold from write time	$t_{DH}$	0	—	0	—	ns	
Output active from end of write	$t_{OW}$	5	—	5	—	ns	2
Output disable to output in high-Z	$t_{OHZ}$	0	15	0	20	ns	1, 2
Write to output in high-Z	$t_{WHZ}$	0	15	0	20	ns	1, 2

**Byte Control**

Parameter	Symbol	R1LV1616H-I				Unit	Notes
		-4SI, -4LI		-5SI			
		Min	Max	Min	Max		
BYTE# setup time	$t_{BS}$	5	—	5	—	ms	
BYTE# recovery time	$t_{BR}$	5	—	5	—	ms	

- Notes:
1.  $t_{CHZ}$ ,  $t_{OHZ}$ ,  $t_{WHZ}$  and  $t_{BHZ}$  are defined as the time at which the outputs achieve the open circuit conditions and are not referred to output voltage levels.
  2. This parameter is sampled and not 100% tested.
  3. At any given temperature and voltage condition,  $t_{HZ}$  max is less than  $t_{LZ}$  min both for a given device and from device to device.
  4. A write occurs during the overlap of a low CS1#, a high CS2, a low WE# and a low LB# or a low UB#. A write begins at the latest transition among CS1# going low, CS2 going high, WE# going low and LB# going low or UB# going low. A write ends at the earliest transition among CS1# going high, CS2 going low, WE# going high and LB# going high or UB# going high.  $t_{WP}$  is measured from the beginning of write to the end of write.
  5.  $t_{CW}$  is measured from the later of CS1# going low or CS2 going high to the end of write.
  6.  $t_{AS}$  is measured from the address valid to the beginning of write.
  7.  $t_{WR}$  is measured from the earliest of CS1# or WE# going high or CS2 going low to the end of write cycle.

## Timing Waveform

### Read Cycle\*<sup>1</sup>

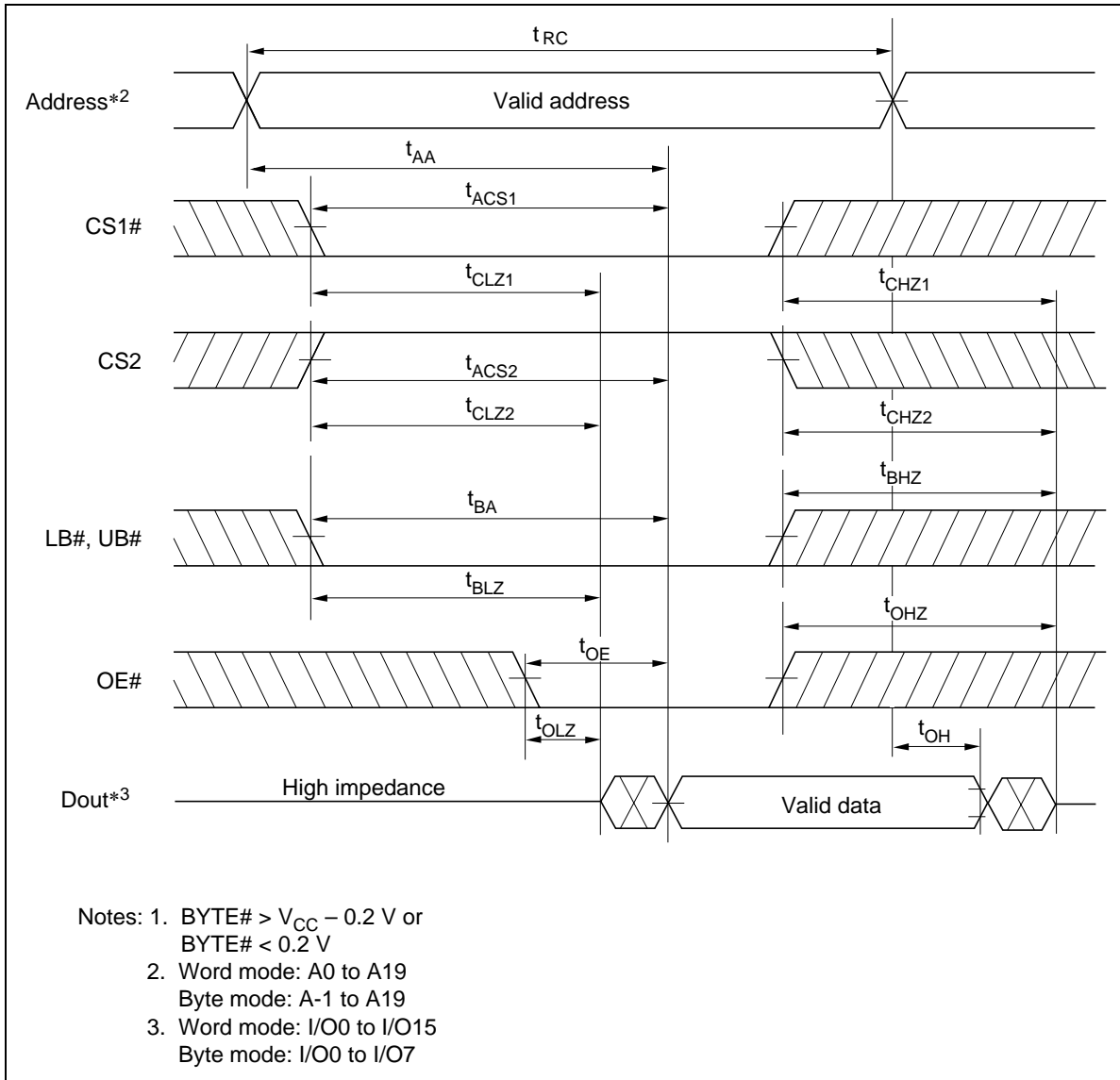

## R1LV1616H-I Series

### Write Cycle (1)\*<sup>1</sup> (WE# Clock)

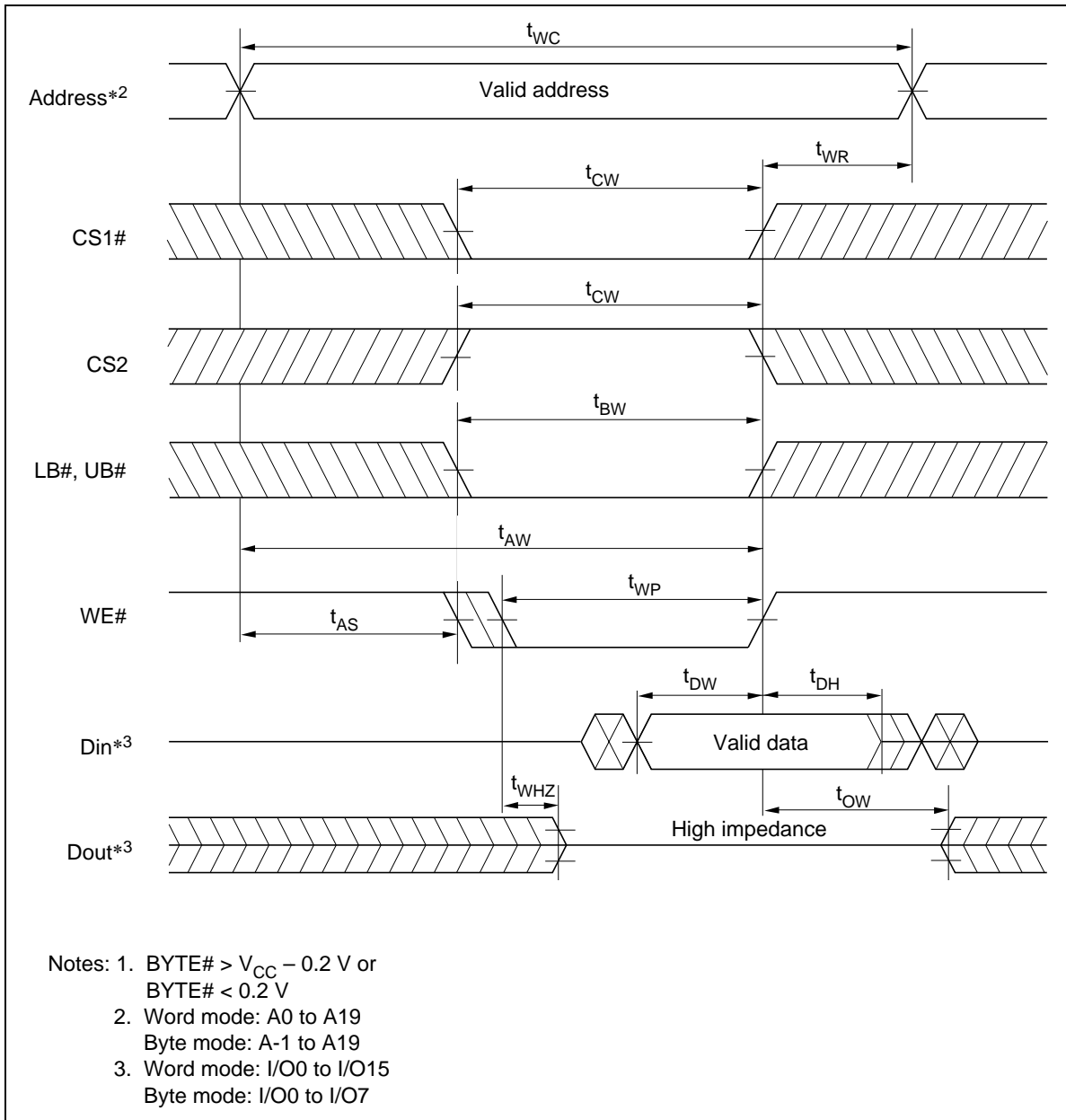

## R1LV1616H-I Series

Write Cycle (2)\*<sup>1</sup> (CS1#, CS2 Clock, OE# = V<sub>IH</sub>)

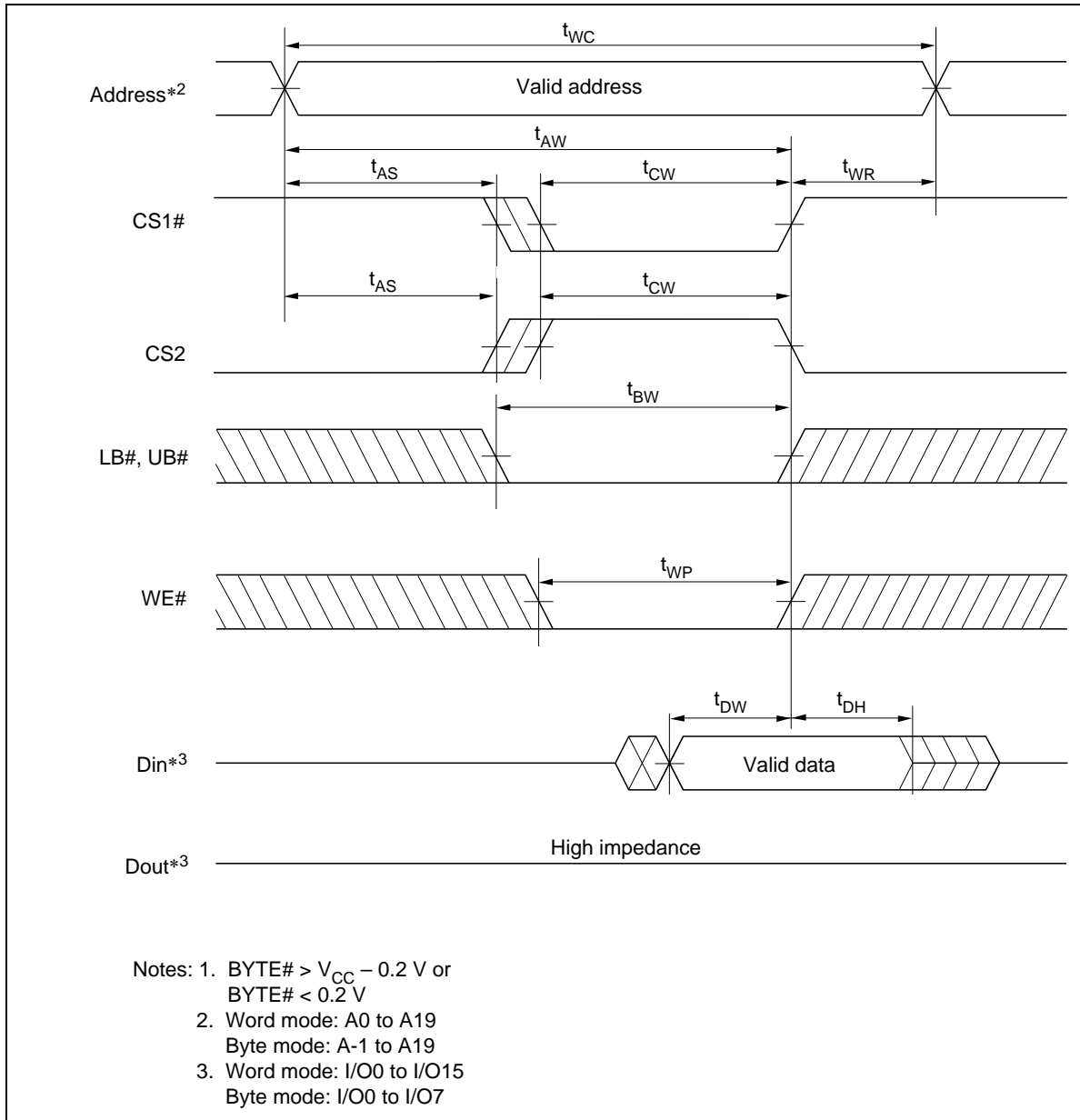

**R1LV1616H-I Series**

**Write Cycle (3)\*<sup>1</sup> (LB#, UB# Clock, OE# = V<sub>IH</sub>)**

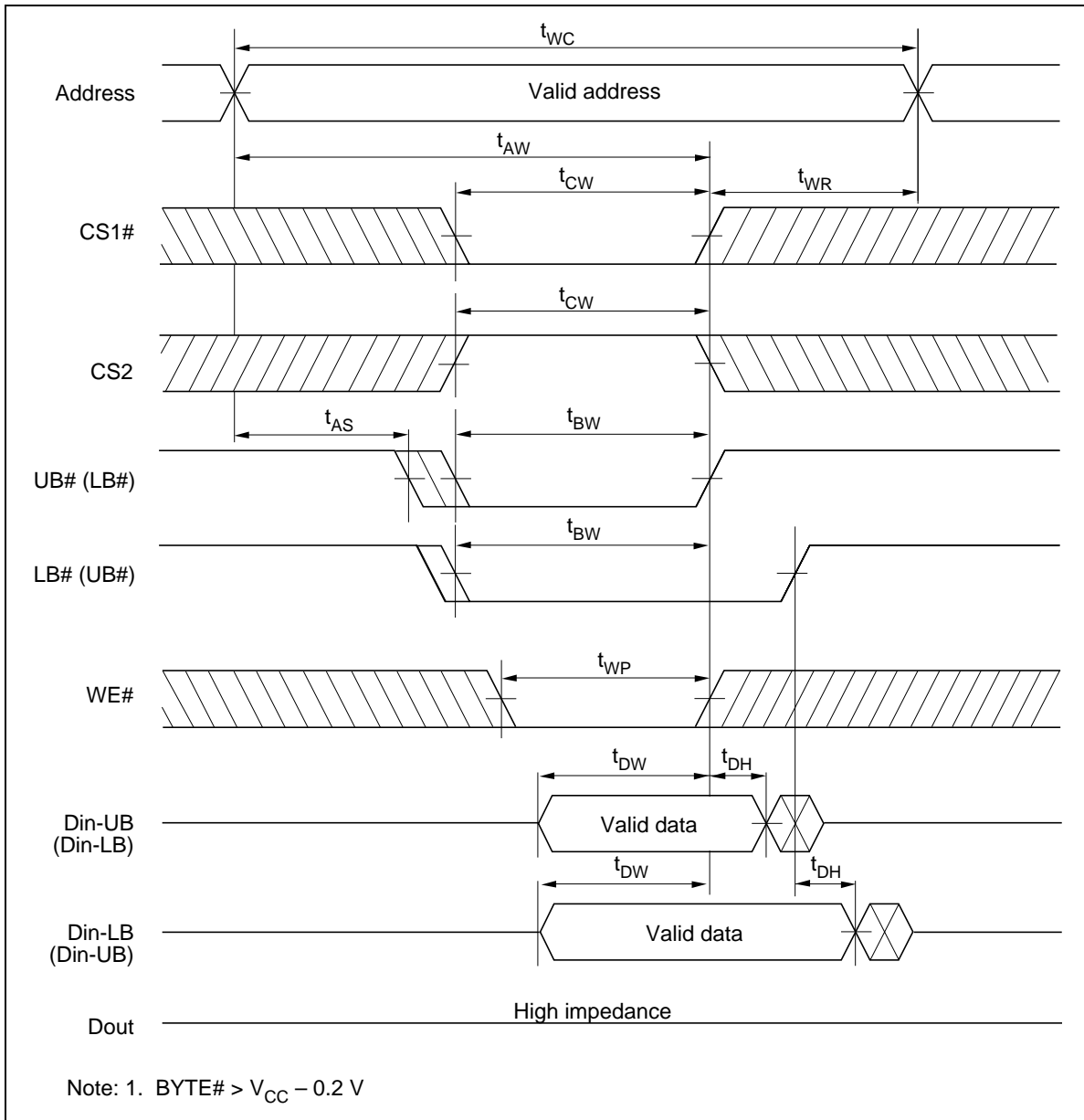



**R1LV1616H-I Series**

---

**Byte Control (TSOP)**

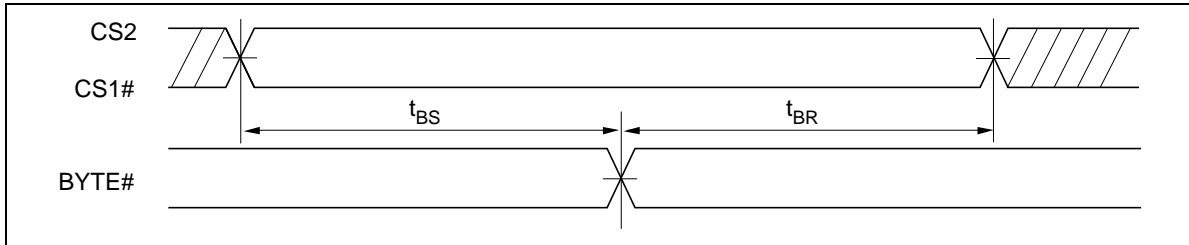

**Low  $V_{CC}$  Data Retention Characteristics**

( $T_a = -40$  to  $+85^\circ\text{C}$ )

Parameter	Symbol	Min	Typ	Max	Unit	Test conditions* <sup>2,3</sup>	
$V_{CC}$ for data retention	$V_{DR}$	1.5	—	3.6	V	$V_{in} \geq 0$ V (1) $0$ V $\leq$ CS2 $\leq$ 0.2 V or (2) CS2 $\geq$ $V_{CC} - 0.2$ V, CS1# $\geq$ $V_{CC} - 0.2$ V or (3) LB# = UB# $\geq$ $V_{CC} - 0.2$ V, CS2 $\geq$ $V_{CC} - 0.2$ V, CS1# $\leq$ 0.2 V	
Data retention current	-4SI	$I_{CCDR}$	—	0.5* <sup>1</sup>	8	$\mu\text{A}$	$V_{CC} = 3.0$ V, $V_{in} \geq 0$ V (1) $0$ V $\leq$ CS2 $\leq$ 0.2 V or (2) CS2 $\geq$ $V_{CC} - 0.2$ V, CS1# $\geq$ $V_{CC} - 0.2$ V or (3) LB# = UB# $\geq$ $V_{CC} - 0.2$ V, CS2 $\geq$ $V_{CC} - 0.2$ V, CS1# $\leq$ 0.2 V Average value
	-5SI			0.5* <sup>1</sup>	25	$\mu\text{A}$	
Chip deselect to data retention time	$t_{CDR}$	0	—	—	ns	See retention waveforms	
Operation recovery time	$t_R$	5	—	—	ms		

Notes: 1. Typical values are at  $V_{CC} = 3.0$  V,  $T_a = +25^\circ\text{C}$  and not guaranteed.

2. BYTE#  $\geq$   $V_{CC} - 0.2$  V or BYTE#  $\leq$  0.2 V

3. CS2 controls address buffer, WE# buffer, CS1# buffer, OE# buffer, LB#, UB# buffer and Din buffer. If CS2 controls data retention mode,  $V_{in}$  levels (address, WE#, OE#, CS1#, LB#, UB#, I/O) can be in the high impedance state. If CS1# controls data retention mode, CS2 must be CS2  $\geq$   $V_{CC} - 0.2$  V or  $0$  V  $\leq$  CS2  $\leq$  0.2 V. The other input levels (address, WE#, OE#, LB#, UB#, I/O) can be in the high impedance state.

## R1LV1616H-I Series

### Low $V_{CC}$ Data Retention Timing Waveform (1) (CS1# Controlled)

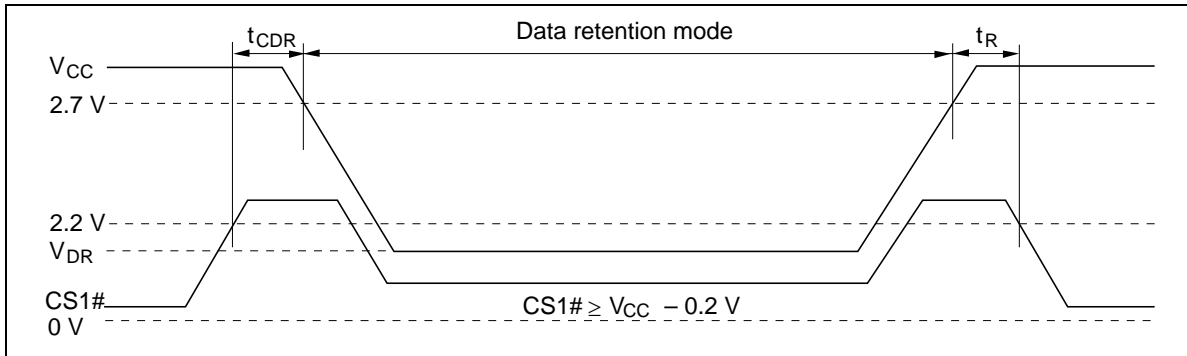

### Low $V_{CC}$ Data Retention Timing Waveform (2) (CS2 Controlled)

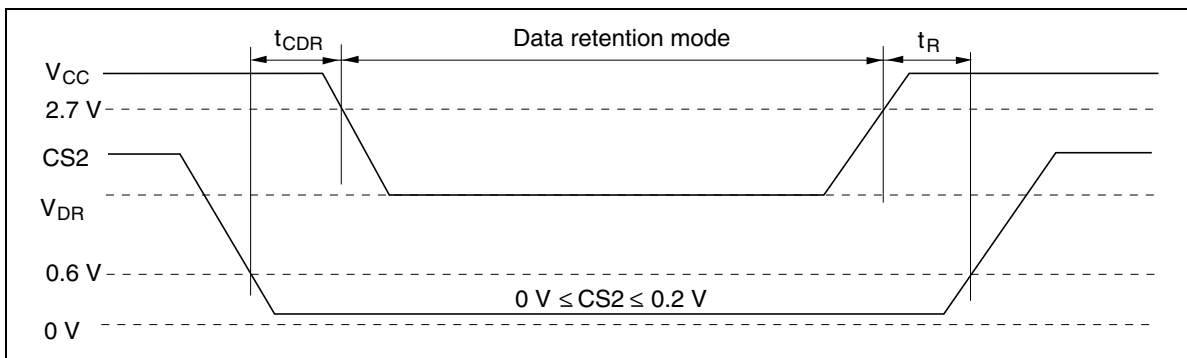

### Low $V_{CC}$ Data Retention Timing Waveform (3) (LB#, UB# Controlled)

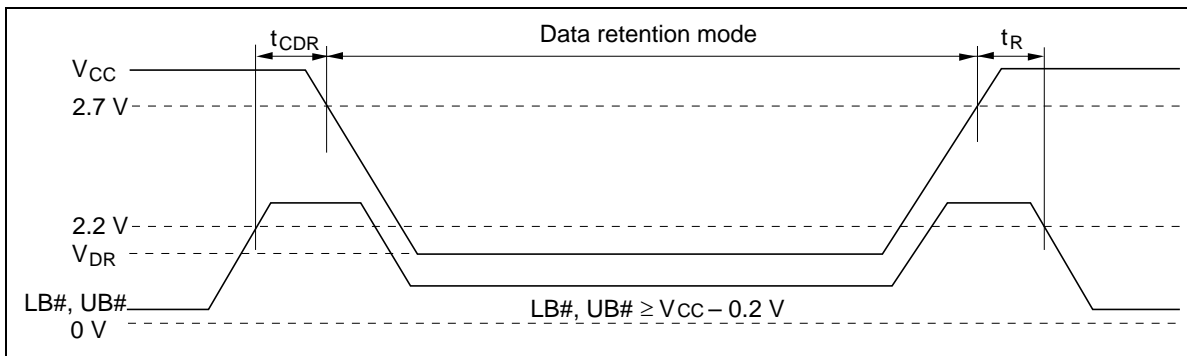

## Revision History

## R1LV1616H-I Series Data Sheet

Rev.	Date	Contents of Modification	
		Page	Description
1.00	Apr. 22, 2004	—	Initial issue
1.01	Nov. 18, 2004	—	Addition of 2-Mword × 8-bit function

## Renesas Technology Corp. Sales Strategic Planning Div. Nippon Bldg., 2-6-2, Ohte-machi, Chiyoda-ku, Tokyo 100-0004, Japan

---

Keep safety first in your circuit designs!

1. Renesas Technology Corp. puts the maximum effort into making semiconductor products better and more reliable, but there is always the possibility that trouble may occur with them. Trouble with semiconductors may lead to personal injury, fire or property damage.  
Remember to give due consideration to safety when making your circuit designs, with appropriate measures such as (i) placement of substitutive, auxiliary circuits, (ii) use of nonflammable material or (iii) prevention against any malfunction or mishap.

Notes regarding these materials

1. These materials are intended as a reference to assist our customers in the selection of the Renesas Technology Corp. product best suited to the customer's application; they do not convey any license under any intellectual property rights, or any other rights, belonging to Renesas Technology Corp. or a third party.
  2. Renesas Technology Corp. assumes no responsibility for any damage, or infringement of any third-party's rights, originating in the use of any product data, diagrams, charts, programs, algorithms, or circuit application examples contained in these materials.
  3. All information contained in these materials, including product data, diagrams, charts, programs and algorithms represents information on products at the time of publication of these materials, and are subject to change by Renesas Technology Corp. without notice due to product improvements or other reasons. It is therefore recommended that customers contact Renesas Technology Corp. or an authorized Renesas Technology Corp. product distributor for the latest product information before purchasing a product listed herein.  
The information described here may contain technical inaccuracies or typographical errors.  
Renesas Technology Corp. assumes no responsibility for any damage, liability, or other loss rising from these inaccuracies or errors.  
Please also pay attention to information published by Renesas Technology Corp. by various means, including the Renesas Technology Corp. Semiconductor home page (<http://www.renesas.com>).
  4. When using any or all of the information contained in these materials, including product data, diagrams, charts, programs, and algorithms, please be sure to evaluate all information as a total system before making a final decision on the applicability of the information and products. Renesas Technology Corp. assumes no responsibility for any damage, liability or other loss resulting from the information contained herein.
  5. Renesas Technology Corp. semiconductors are not designed or manufactured for use in a device or system that is used under circumstances in which human life is potentially at stake. Please contact Renesas Technology Corp. or an authorized Renesas Technology Corp. product distributor when considering the use of a product contained herein for any specific purposes, such as apparatus or systems for transportation, vehicular, medical, aerospace, nuclear, or undersea repeater use.
  6. The prior written approval of Renesas Technology Corp. is necessary to reprint or reproduce in whole or in part these materials.
  7. If these products or technologies are subject to the Japanese export control restrictions, they must be exported under a license from the Japanese government and cannot be imported into a country other than the approved destination.  
Any diversion or reexport contrary to the export control laws and regulations of Japan and/or the country of destination is prohibited.
  8. Please contact Renesas Technology Corp. for further details on these materials or the products contained therein.
- 



### RENESAS SALES OFFICES

<http://www.renesas.com>

Refer to "<http://www.renesas.com/en/network>" for the latest and detailed information.

#### **Renesas Technology America, Inc.**

450 Holger Way, San Jose, CA 95134-1368, U.S.A  
Tel: <1> (408) 382-7500, Fax: <1> (408) 382-7501

#### **Renesas Technology Europe Limited**

Dukes Meadow, Millboard Road, Bourne End, Buckinghamshire, SL8 5FH, U.K.  
Tel: <44> (1628) 585-100, Fax: <44> (1628) 585-900

#### **Renesas Technology Hong Kong Ltd.**

7th Floor, North Tower, World Finance Centre, Harbour City, 1 Canton Road, Tsimshatsui, Kowloon, Hong Kong  
Tel: <852> 2265-6688, Fax: <852> 2730-6071

#### **Renesas Technology Taiwan Co., Ltd.**

10th Floor, No.99, Fushing North Road, Taipei, Taiwan  
Tel: <886> (2) 2715-2888, Fax: <886> (2) 2713-2999

#### **Renesas Technology (Shanghai) Co., Ltd.**

Unit2607 Ruijing Building, No.205 Maoming Road (S), Shanghai 200020, China  
Tel: <86> (21) 6472-1001, Fax: <86> (21) 6415-2952

#### **Renesas Technology Singapore Pte. Ltd.**

1 Harbour Front Avenue, #06-10, Keppel Bay Tower, Singapore 098632  
Tel: <65> 6213-0200, Fax: <65> 6278-8001