



Is Now Part of



ON Semiconductor®

To learn more about ON Semiconductor, please visit our website at
www.onsemi.com

ON Semiconductor and the ON Semiconductor logo are trademarks of Semiconductor Components Industries, LLC dba ON Semiconductor or its subsidiaries in the United States and/or other countries. ON Semiconductor owns the rights to a number of patents, trademarks, copyrights, trade secrets, and other intellectual property. A listing of ON Semiconductor's product/patent coverage may be accessed at www.onsemi.com/site/pdf/Patent-Marking.pdf. ON Semiconductor reserves the right to make changes without further notice to any products herein. ON Semiconductor makes no warranty, representation or guarantee regarding the suitability of its products for any particular purpose, nor does ON Semiconductor assume any liability arising out of the application or use of any product or circuit, and specifically disclaims any and all liability, including without limitation special, consequential or incidental damages. Buyer is responsible for its products and applications using ON Semiconductor products, including compliance with all laws, regulations and safety requirements or standards, regardless of any support or applications information provided by ON Semiconductor. "Typical" parameters which may be provided in ON Semiconductor data sheets and/or specifications can and do vary in different applications and actual performance may vary over time. All operating parameters, including "Typicals" must be validated for each customer application by customer's technical experts. ON Semiconductor does not convey any license under its patent rights nor the rights of others. ON Semiconductor products are not designed, intended, or authorized for use as a critical component in life support systems or any FDA Class 3 medical devices or medical devices with a same or similar classification in a foreign jurisdiction or any devices intended for implantation in the human body. Should Buyer purchase or use ON Semiconductor products for any such unintended or unauthorized application, Buyer shall indemnify and hold ON Semiconductor and its officers, employees, subsidiaries, affiliates, and distributors harmless against all claims, costs, damages, and expenses, and reasonable attorney fees arising out of, directly or indirectly, any claim of personal injury or death associated with such unintended or unauthorized use, even if such claim alleges that ON Semiconductor was negligent regarding the design or manufacture of the part. ON Semiconductor is an Equal Opportunity/Affirmative Action Employer. This literature is subject to all applicable copyright laws and is not for resale in any manner.



FPF1005-FPF1006 IntelliMAX™ Advanced Load Management Products

Features

- 1.2 to 5.5V Input Voltage Range
- Typical $R_{DS(ON)} = 50m\Omega @ V_{IN} = 5.5V$
- Typical $R_{DS(ON)} = 55m\Omega @ V_{IN} = 3.3V$
- ESD Protected, above 2000V HBM

Applications

- PDAs
- Cell Phones
- GPS Devices
- MP3 Players
- Digital Cameras
- Peripheral Ports
- Hot Swap Supplies
- RoHS Compliant

General Description

The FPF1005 & FPF1006 are low R_{DS} P-Channel MOSFET load switches with CMOS controlled turn-on targeting small package load switch applications. The input voltage range operates from 1.2V to 5.5V. Switch control is by a logic input (ON) capable of interfacing directly with low voltage control signals. In FPF1006, 120 Ω on-chip load resistor is added for output quick discharge when switch is turned off.

Both FPF1005 & FPF1006 are available in a small 2X2 MicroFET-6 pin plastic package.

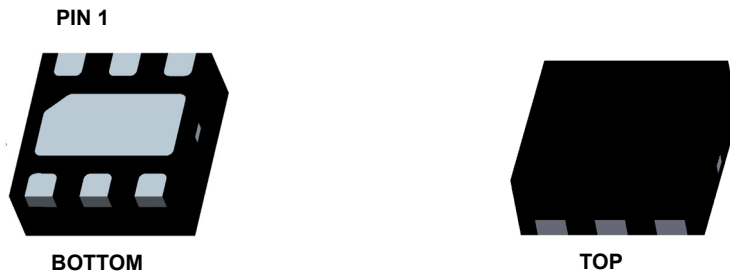

Typical Application Circuit

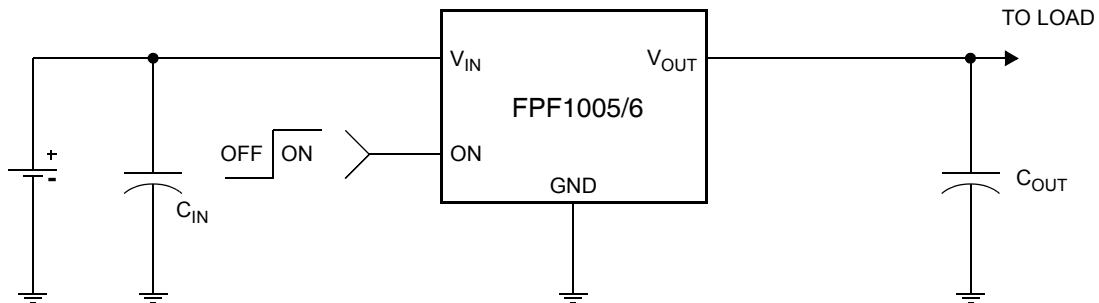

Ordering Information

Part	Switch	Input Buffer	Output Discharge	ON Pin Activity
FPF1005	55m Ω , PMOS	Schmitt	NA	Active HI
FPF1006	55m Ω , PMOS	Schmitt	120 Ω	Active HI

Functional Block Diagram

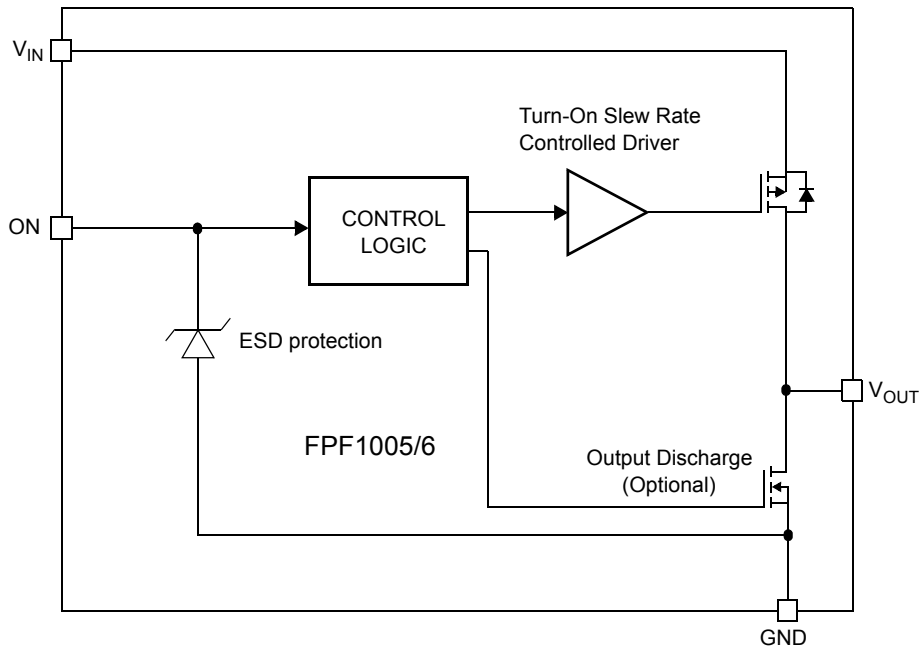

Pin Configuration

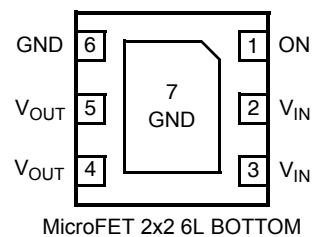

Pin Description

Pin	Name	Function
4, 5	V_{OUT}	Switch Output: Output of the power switch
2, 3	V_{IN}	Supply Input: Input to the power switch and the supply voltage for the IC
6, 7	GND	Ground
1	ON	ON/OFF Control Input

Absolute Maximum Ratings

Parameter	Min	Max	Unit
V_{IN} , V_{OUT} , ON to GND	-0.3	6	V
Maximum Continuous Switch Current		1.5	A
Power Dissipation @ $T_A = 25^\circ\text{C}$ (Note 1)		1.2	W
Operating Temperature Range	-40	85	$^\circ\text{C}$
Storage Temperature	-65	150	$^\circ\text{C}$
Thermal Resistance, Junction to Ambient		86	$^\circ\text{C}/\text{W}$
Electrostatic Discharge Protection	HBM	2000	V
	MM	200	V

Recommended Operating Range

Parameter	Min	Max	Unit
V_{IN}	1.2	5.5	V
Ambient Operating Temperature, T_A	-40	85	$^\circ\text{C}$

Electrical Characteristics

$V_{IN} = 1.2$ to 5.5V , $T_A = -40$ to $+85^\circ\text{C}$ unless otherwise noted. Typical values are at $V_{IN} = 3.3\text{V}$ and $T_A = 25^\circ\text{C}$.

Parameter	Symbol	Conditions	Min	Typ	Max	Unit
Basic Operation						
Operating Voltage	V_{IN}		1.2		5.5	V
Quiescent Current	I_Q	$I_{OUT} = 0\text{mA}$, $V_{IN} = V_{ON}$			1	μA
Off Supply Current	$I_{Q(off)}$	$V_{ON} = \text{GND}$, $\text{OUT} = \text{open}$			1	μA
Off Switch Current	$I_{SD(off)}$	$V_{ON} = \text{GND}$, $V_{OUT} = 0\text{V}$ @ $V_{IN} = 5.5\text{V}$, $T_A = 85^\circ\text{C}$			1	μA
		$V_{ON} = \text{GND}$, $V_{OUT} = 0\text{V}$ @ $V_{IN} = 3.3\text{V}$, $T_A = 25^\circ\text{C}$		10	100	nA
On-Resistance	R_{ON}	$V_{IN} = 5.5\text{V}$, $T_A = 25^\circ\text{C}$		50	70	m Ω
		$V_{IN} = 3.3\text{V}$, $T_A = 25^\circ\text{C}$		55	80	
		$V_{IN} = 1.5\text{V}$, $T_A = 25^\circ\text{C}$		95	135	
		$V_{IN} = 1.2\text{V}$, $T_A = 25^\circ\text{C}$		165	250	
Output Pull Down Resistance	R_{PD}	$V_{IN} = 3.3\text{V}$, $V_{ON} = 0\text{V}$, $T_A = 25^\circ\text{C}$, FPF1006		75	120	Ω
ON Input Logic Low Voltage	V_{IL}	$V_{IN} = 5.5\text{V}$			1.25	V
		$V_{IN} = 4.5\text{V}$			1.10	
		$V_{IN} = 1.5\text{V}$			0.50	
ON Input Logic High Voltage	V_{IH}	$V_{IN} = 5.5\text{V}$	2.00			V
		$V_{IN} = 4.5\text{V}$	1.75			
		$V_{IN} = 1.5\text{V}$	0.75			
ON Input Leakage		$V_{ON} = V_{IN}$ or GND	-1		1	μA
Dynamic						
Turn on delay	t_{ON}	$V_{IN} = 3.3\text{V}$, $R_L = 500\Omega$, $C_L = 0.1\mu\text{F}$, $T_A = 25^\circ\text{C}$		10		μs
Turn off delay	t_{OFF}	$V_{IN} = 3.3\text{V}$, $R_L = 500\Omega$, $C_L = 0.1\mu\text{F}$, $T_A = 25^\circ\text{C}$, FPF1005		50		μs
		$V_{IN} = 3.3\text{V}$, $R_L = 500\Omega$, $C_L = 0.1\mu\text{F}$, $R_{L_CHIP} = 120\Omega$, $T_A = 25^\circ\text{C}$, FPF1006		10		μs
V_{OUT} Rise Time	t_R	$V_{IN} = 3.3\text{V}$, $R_L = 500\Omega$, $C_L = 0.1\mu\text{F}$, $T_A = 25^\circ\text{C}$		10		μs
V_{OUT} Fall Time	t_F	$V_{IN} = 3.3\text{V}$, $R_L = 500\Omega$, $C_L = 0.1\mu\text{F}$, $T_A = 25^\circ\text{C}$, FPF1005		100		μs
		$V_{IN} = 3.3\text{V}$, $R_L = 500\Omega$, $C_L = 0.1\mu\text{F}$, $R_{L_CHIP} = 120\Omega$, $T_A = 25^\circ\text{C}$, FPF1006		10		μs

Note 1: Package power dissipation on 1square inch pad, 2 oz. copper board

Typical Characteristics

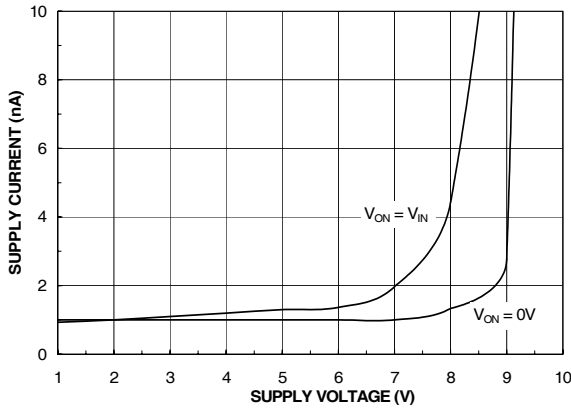

Figure 1. Quiescent Current vs. V_{IN}

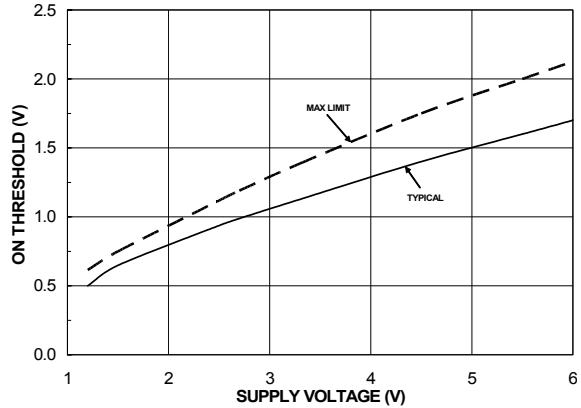

Figure 2. ON Threshold vs. V_{IN}

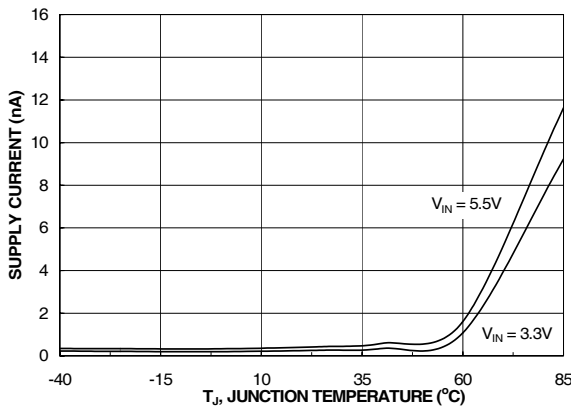

Figure 3. Quiescent Current vs. Temperature

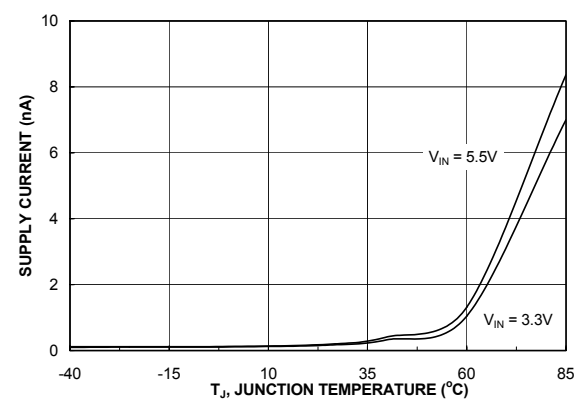

Figure 4. Quiescent Current (off) vs. Temperature

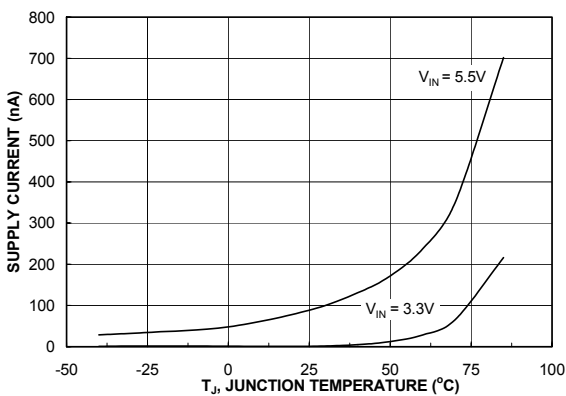

Figure 5. $I_{\text{SWITCH-OFF}}$ Current vs. Temperature

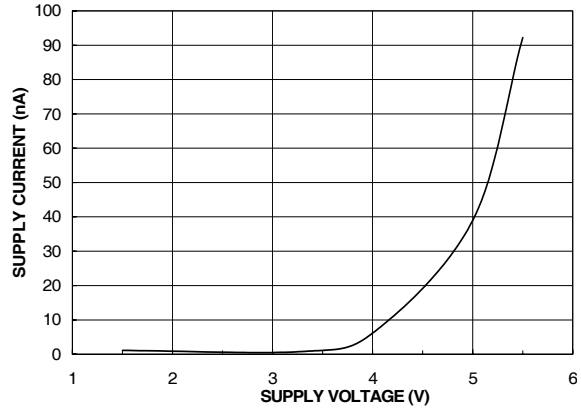

Figure 6. $I_{\text{SWITCH-OFF}}$ Current vs. V_{IN}

Typical Characteristics

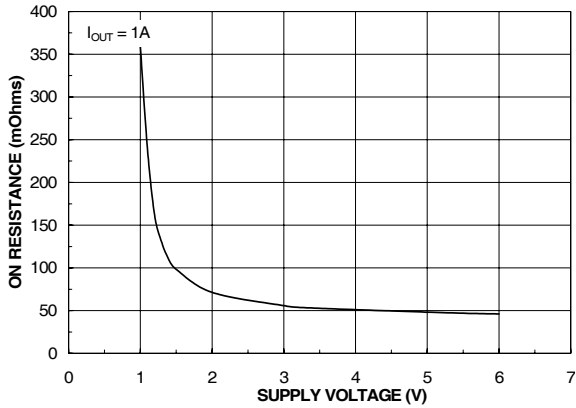

Figure 7. R_{ON} vs. V_{IN}

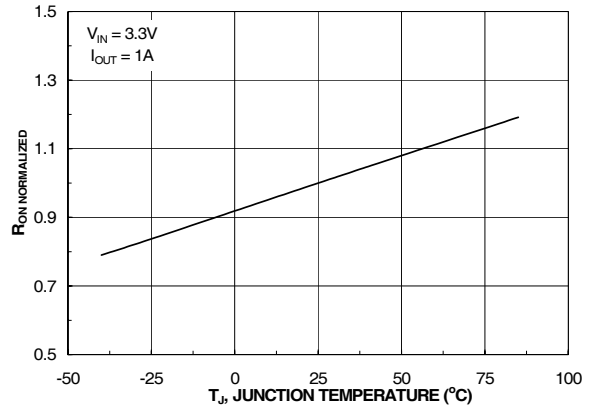

Figure 8. R_{ON} vs. Temperature

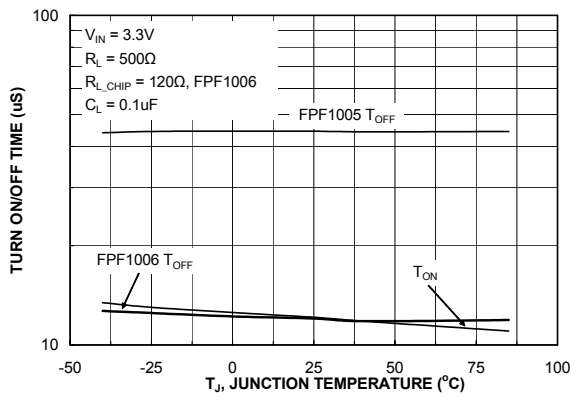

Figure 9. T_{ON}/T_{OFF} vs. Temperature

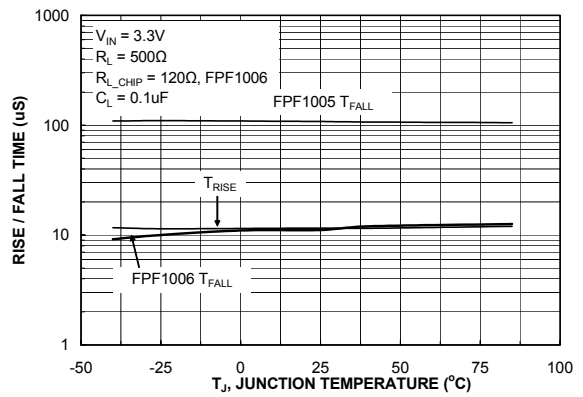

Figure 10. T_{RISE}/T_{FALL} vs. Temperature

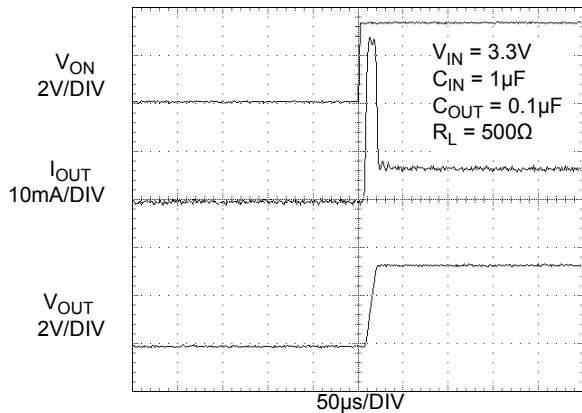

Figure 11. FPF1005 T_{ON} Response

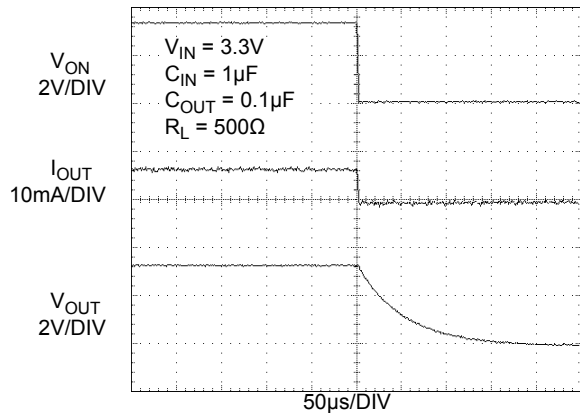

Figure 12. FPF1005 T_{OFF} Response

Typical Characteristics

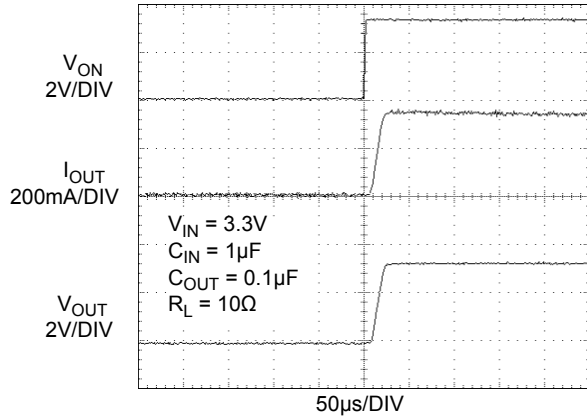

Figure 13. FPF1005 T_{ON} Response

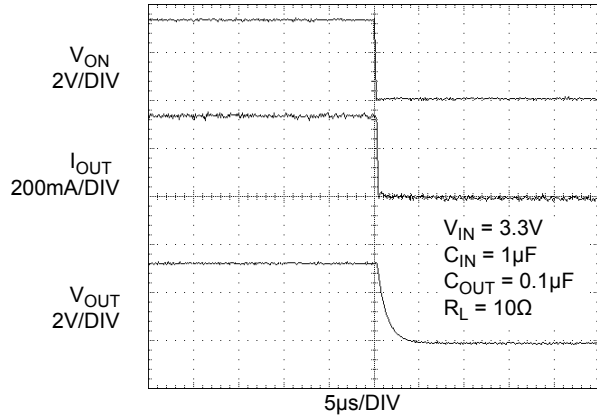

Figure 14. FPF1005 T_{OFF} Response

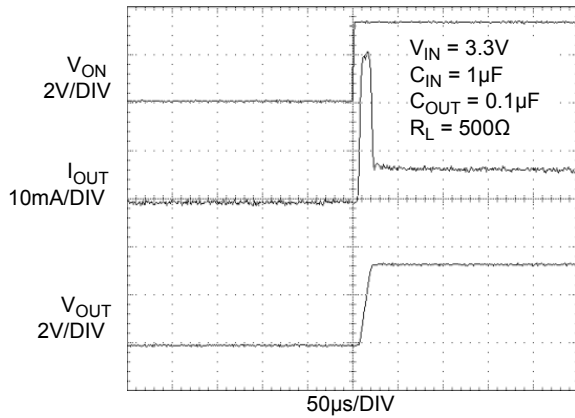

Figure 15. FPF1006 T_{ON} Response

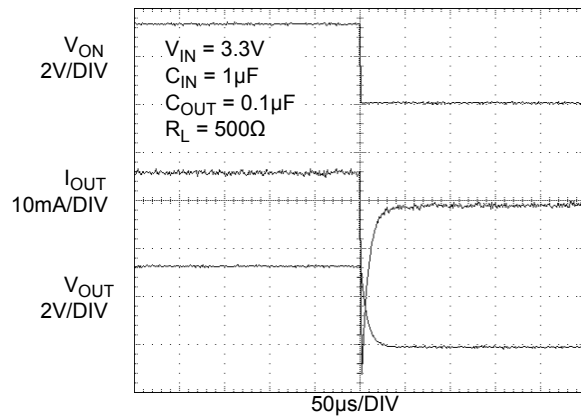

Figure 16. FPF1006 T_{OFF} Response

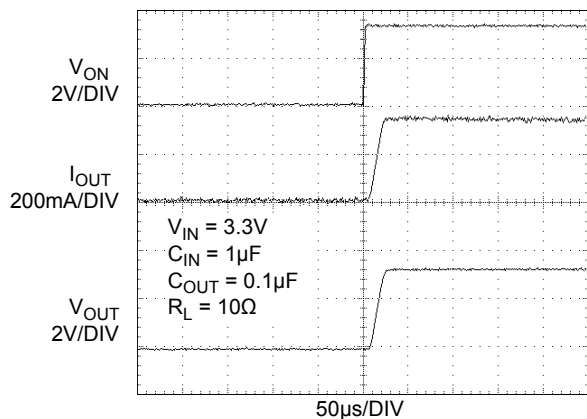

Figure 17. FPF1006 T_{ON} Response

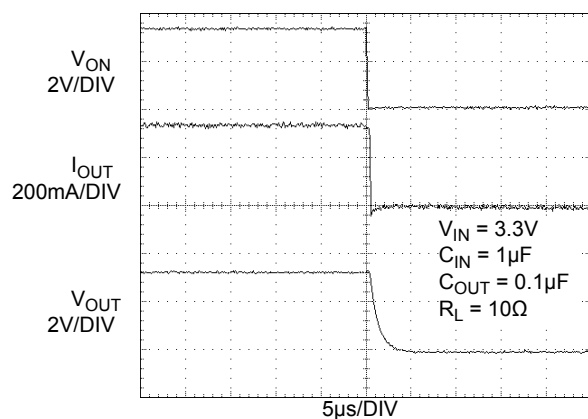

Figure 18. FPF1006 T_{OFF} Response

Description of Operation

The FPF1005 & FPF1006 are low $R_{DS(ON)}$ P-Channel load switches with controlled turn-on. The core of each device is a 55mΩ P-Channel MOSFET and a controller capable of functioning over a wide input operating range of 1.2-5.5V. The ON pin, an active HI TTL compatible input, controls the state of the switch. The FPF1006 contains a 120Ω on-chip load resistor for quick output discharge when the switch is turned off.

However, V_{OUT} pin of FPF1006 should not be connected directly to the battery source due to the discharge mechanism of the load switch.

Application Information

Typical Application

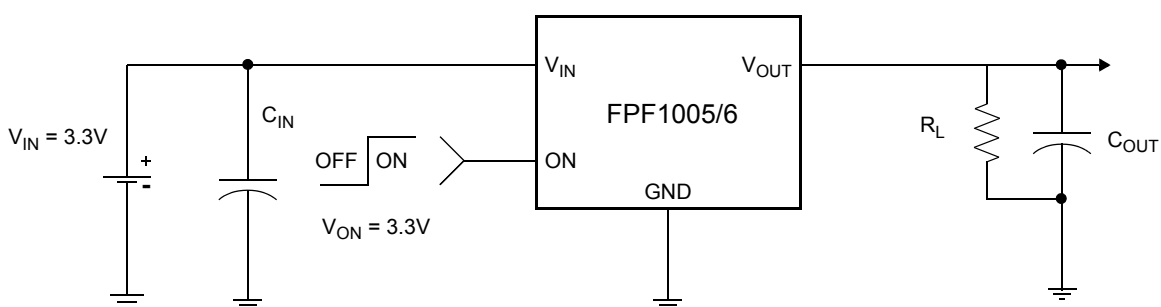

Input Capacitor

To limit the voltage drop on the input supply caused by transient in-rush currents when the switch turns-on into a discharged load capacitor or short-circuit, a capacitor needs to be placed between V_{IN} and GND. A 1μF ceramic capacitor, C_{IN} , placed close to the pins is usually sufficient. Higher values of C_{IN} can be used to further reduce the voltage drop during higher current application.

Output Capacitor

A 0.1μF capacitor, C_{OUT} , should be placed between V_{OUT} and GND. This capacitor will prevent parasitic board inductance from forcing V_{OUT} below GND when the switch turns-off. Due to the integral body diode in the PMOS switch, a C_{IN} greater than C_{OUT} is highly recommended. A C_{OUT} greater than C_{IN} can cause V_{OUT} to exceed V_{IN} when the system supply is removed. This could result in current flow through the body diode from V_{OUT} to V_{IN} .

Board Layout

For best performance, all traces should be as short as possible. To be most effective, the input and output capacitors should be placed close to the device to minimize the effects that parasitic trace inductances may have on normal and short-circuit operation. Using wide traces or large copper planes for all pins (V_{IN} , V_{OUT} , ON and GND) will help minimize the parasitic electrical effects along with minimizing the case to ambient thermal impedance.

Evaluation Board Layout

FPF1005/6 Demo board has the components and circuitry to demonstrate the load switch functions. Thermal performance of the load switch can be improved significantly by connecting the middle pad (pin 7) to the GND area of the PCB.

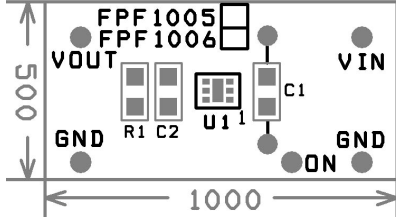

Figure 19. Demo board silk screen top and component assembly drawing.

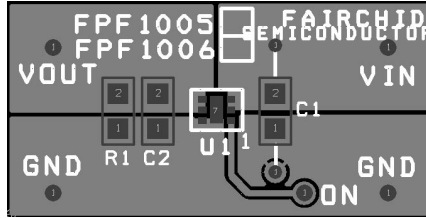

Figure 20. Demo board top and surface mount top layers view. (Pin 7 is connected to GND).

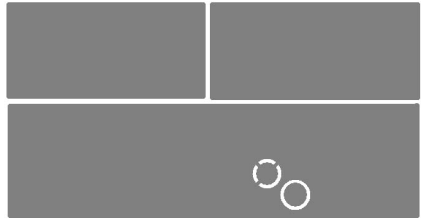
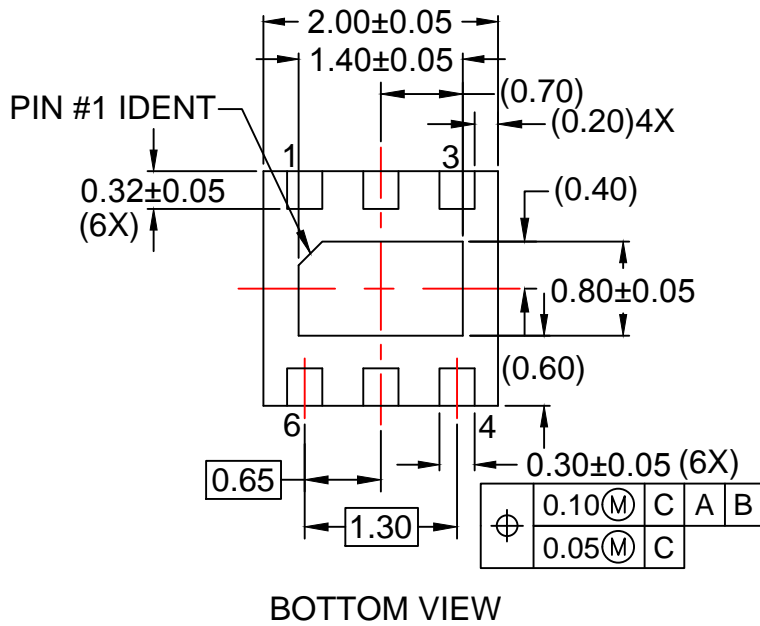
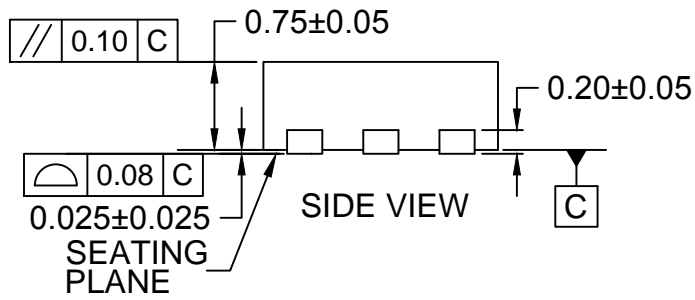
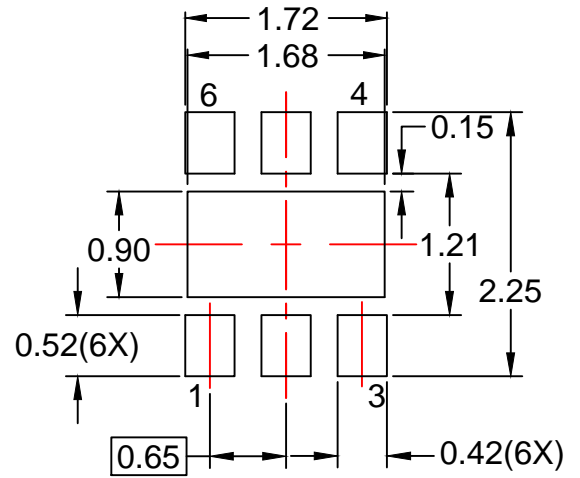
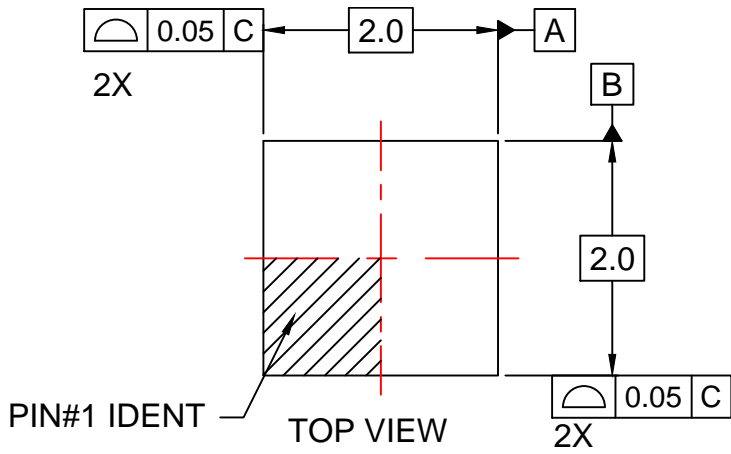

Figure 21. Demo board bottom layer view.



NOTES:

- A. PACKAGE DOES NOT FULLY CONFORM TO JEDEC MO-229 REGISTRATION
- B. DIMENSIONS ARE IN MILLIMETERS.
- C. DIMENSIONS AND TOLERANCES PER ASME Y14.5M, 2009.
- D. LAND PATTERN RECOMMENDATION IS EXISTING INDUSTRY LAND PATTERN.
- E. DRAWING FILENAME: MKT-MLP06Krev5.



ON Semiconductor and  are trademarks of Semiconductor Components Industries, LLC dba ON Semiconductor or its subsidiaries in the United States and/or other countries. ON Semiconductor owns the rights to a number of patents, trademarks, copyrights, trade secrets, and other intellectual property. A listing of ON Semiconductor's product/patent coverage may be accessed at www.onsemi.com/site/pdf/Patent-Marking.pdf. ON Semiconductor reserves the right to make changes without further notice to any products herein. ON Semiconductor makes no warranty, representation or guarantee regarding the suitability of its products for any particular purpose, nor does ON Semiconductor assume any liability arising out of the application or use of any product or circuit, and specifically disclaims any and all liability, including without limitation special, consequential or incidental damages. Buyer is responsible for its products and applications using ON Semiconductor products, including compliance with all laws, regulations and safety requirements or standards, regardless of any support or applications information provided by ON Semiconductor. "Typical" parameters which may be provided in ON Semiconductor data sheets and/or specifications can and do vary in different applications and actual performance may vary over time. All operating parameters, including "Typicals" must be validated for each customer application by customer's technical experts. ON Semiconductor does not convey any license under its patent rights nor the rights of others. ON Semiconductor products are not designed, intended, or authorized for use as a critical component in life support systems or any FDA Class 3 medical devices or medical devices with a same or similar classification in a foreign jurisdiction or any devices intended for implantation in the human body. Should Buyer purchase or use ON Semiconductor products for any such unintended or unauthorized application, Buyer shall indemnify and hold ON Semiconductor and its officers, employees, subsidiaries, affiliates, and distributors harmless against all claims, costs, damages, and expenses, and reasonable attorney fees arising out of, directly or indirectly, any claim of personal injury or death associated with such unintended or unauthorized use, even if such claim alleges that ON Semiconductor was negligent regarding the design or manufacture of the part. ON Semiconductor is an Equal Opportunity/Affirmative Action Employer. This literature is subject to all applicable copyright laws and is not for resale in any manner.

PUBLICATION ORDERING INFORMATION

LITERATURE FULFILLMENT:

Literature Distribution Center for ON Semiconductor
19521 E. 32nd Pkwy, Aurora, Colorado 80011 USA
Phone: 303-675-2175 or 800-344-3860 Toll Free USA/Canada
Fax: 303-675-2176 or 800-344-3867 Toll Free USA/Canada
Email: orderlit@onsemi.com

N. American Technical Support: 800-282-9855 Toll Free
USA/Canada
Europe, Middle East and Africa Technical Support:
Phone: 421 33 790 2910
Japan Customer Focus Center
Phone: 81-3-5817-1050

ON Semiconductor Website: www.onsemi.com
Order Literature: <http://www.onsemi.com/orderlit>
For additional information, please contact your local
Sales Representative