



MIC23158/9

3MHz PWM Dual 2A Buck Regulator with HyperLight Load® and Power Good

General Description

The MIC23158/9 is a high-efficiency, 3MHz, dual, 2A synchronous buck regulator with HyperLight Load® mode, power good output indicator, and programmable soft start.

The MIC23159 also provides an auto discharge feature that switches in a 225Ω pull down circuit on its output to discharge the output capacitor when disabled. HyperLight Load provides very high efficiency at light loads and ultra-fast transient response which makes the MIC23158/9 perfectly suited for supplying processor core voltages. An additional benefit of this proprietary architecture is very low output ripple voltage throughout the entire load range with the use of small output capacitors. The 20-pin 3mm x 4mm MLF® package saves precious board space and requires seven external components for each channel.

The MIC23158/9 is designed for use with a very small inductor, down to 0.47μH, and an output capacitor as small as 2.2μF that enables a total solution size, less than 1mm in height.

The MIC23158/9 has a very low quiescent current of 45μA and achieves a peak efficiency of 94% in continuous conduction mode. In discontinuous conduction mode, the MIC23158/9 can achieve 83% efficiency at 1mA.

The MIC23158/9 is available in a 20-pin 3mm x 4mm MLF package with an operating junction temperature range from -40°C to +125°C.

Datasheets and support documentation can be found on Micrel's web site at: www.micrel.com.

Features

- 2.7V to 5.5V input voltage
- Adjustable output voltage (down to 1.0V)
- 2 independent 2A outputs
- Up to 94% peak efficiency
- 83% typical efficiency at 1mA
- 2 independent power good indicators
- Independent programmable soft start
- 45μA typical quiescent current
- 3MHz PWM operation in continuous conduction mode
- Ultra-fast transient response
- Fully-integrated MOSFET switches
- Output pre-bias safe
- 0.1μA shutdown current
- Thermal-shutdown and current-limit protection
- 20-pin 3mm x 4mm MLF package
- Internal 225Ω pull-down circuit on output (MIC23159)
- -40°C to +125°C junction temperature range

Applications

- Solid State Drives (SSD)
- Smart phones
- Tablet PCs
- Mobile handsets
- Portable devices (PMP, PND, UMPC, GPS)
- WiFi/WiMax/WiBro applications

Typical Application

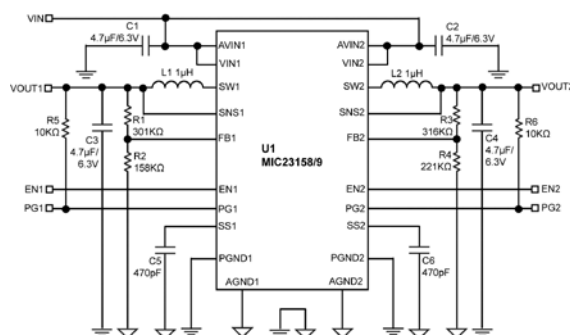

HyperLight Load is a registered trademark of Micrel, Inc.
MLF and MicroLeadFrame are registered trademarks Amkor Technology, Inc.

Micrel Inc. • 2180 Fortune Drive • San Jose, CA 95131 • USA • tel +1 (408) 944-0800 • fax +1 (408) 474-1000 • <http://www.micrel.com>

Ordering Information

Part Number	Nominal Output Voltage		Output Auto Discharge	Junction Temperature Range	Package
	V _{OUT1}	V _{OUT2}			
MIC23158YML	ADJ	ADJ	NO	-40°C to +125°C	20-Pin 3mm x 4mm MLF
MIC23159YML	ADJ	ADJ	YES	-40°C to +125°C	20-Pin 3mm x 4mm MLF

Notes:

1. Fixed output voltage options available. Contact Micrel Marketing for details.
2. MLF is a GREEN RoHS-compliant package. Lead finish is NiPdAu. Mold compound is Halogen Free.

Pin Configuration

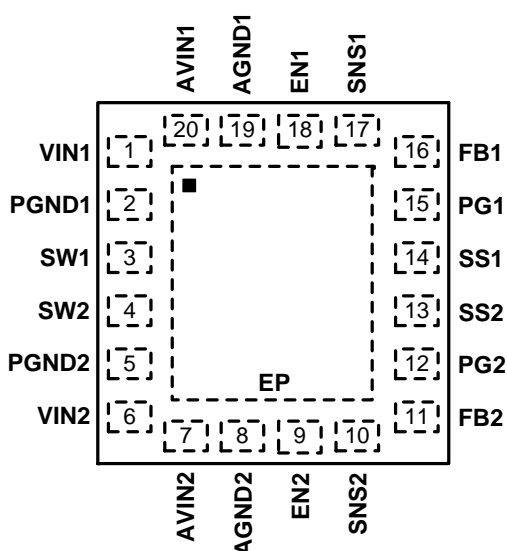

3mm x 4mm MLF (ML) Adjustable Output Voltage
(Top View)

Pin Description

Pin Number (Adjustable)	Pin Name	Pin Function
1	VIN1	Power Input Voltage for Regulator 1. Connect a capacitor to ground to decouple noise and switching transients.
2	PGND1	Power Ground for Regulator 1.
3	SW1	Switch (Output): Internal power MOSFET output switches for regulator 1.
4	SW2	Switch (Output): Internal power MOSFET output switches for regulator 2.
5	PGND2	Power Ground for Regulator 2.
6	VIN2	Power Input Voltage for Regulator 2. Connect a capacitor to ground to decouple noise and switching transients.
7	AVIN2	Analog Input Voltage for Regulator 2. Tie to VIN2 and connect a capacitor to ground to decouple noise.

Pin Description (Continued)

Pin Number (Adjustable)	Pin Name	Pin Function
8	AGND2	Analog Ground for Regulator 2. Connect to a central ground point where all high current paths meet (C_{IN} , C_{OUT} , PGND2) for best operation.
9	EN2	Enable Input for Regulator 2. Logic high enables operation of regulator 2. Logic low will shut down regulator 2. Do not leave floating.
10	SNS2	Sense Input for Regulator 2. Connect to the output of regulator 2 as close to the output capacitor as possible to accurately sense the output voltage.
11	FB2	Feedback Input for Regulator 2. Connect a resistor divider from the output of regulator 2 to ground to set the output voltage.
12	PG2	Power Good Output for Regulator 2. Open drain output for the power good indicator for output 2. Use a pull-up resistor between this pin and V_{OUT2} to indicate a power good condition.
13	SS2	Soft-Start for Regulator 2. Connect a minimum of 200pF capacitor to ground to set the turn-on time of regulator 2. Do not leave floating.
14	SS1	Soft-Start for Regulator 1. Connect a minimum of 200pF capacitor to ground to set the turn-on time of regulator 1. Do not leave floating.
15	PG1	Power Good Output for Regulator 1. Open drain output for the power good indicator for output 1. Use a pull-up resistor between this pin and V_{OUT1} to indicate a power good condition.
16	FB1	Feedback Input for Regulator 1. Connect a resistor divider from the output of regulator 1 to ground to set the output voltage.
17	SNS1	Sense Input for Regulator 1. Connect to the output of regulator 1 as close to the output capacitor as possible to accurately sense the output voltage.
18	EN1	Enable Input for Regulator 1. Logic high enables operation of regulator 1. Logic low will shut down regulator 1. Do not leave floating.
19	AGND1	Analog Ground for Regulator 1. Connect to a central ground point where all high current paths meet (C_{IN} , C_{OUT} , PGND1) for best operation.
20	AVIN1	Analog Input Voltage for Regulator 1. Tie to VIN1 and connect a capacitor to ground to decouple noise.
EP	ePad	Exposed Heat Sink Pad. Connect to PGND.

Absolute Maximum Ratings⁽¹⁾

Supply Voltage (AVIN1, AVIN2, VIN1, VIN2).... -0.3V to 6V
 Switch1 (V_{SW1}), Sense1 (V_{SNS1}).....-0.3V to VIN1
 Enable1 (V_{EN1}), Power Good1 (V_{PG1})-0.3V to VIN1
 Feedback1 (V_{FB1}) -0.3V to VIN1
 Switch2 (V_{SW2}), Sense2 (V_{SNS2})..... -0.3V to VIN2
 Enable2 (V_{EN2}), Power Good2 (V_{PG2})-0.3V to VIN2
 Feedback2 (V_{FB2})-0.3V to VIN2
 Power Dissipation T_A = 70°C Internally Limited
 Storage Temperature Range -65°C to +150°C
 Lead Temperature (soldering, 10s)..... 260°C
 ESD Rating⁽³⁾ ESD sensitive

Operating Ratings⁽²⁾

Supply Voltage (AVIN1, VIN1) +2.7V to +5.5V
 Supply Voltage (AVIN2, VIN2) +2.7V to +5.5V
 Enable Input Voltage (V_{EN1}, V_{EN2}) 0V to V_{IN1,2}
 Output Voltage Range (V_{SNS1}, V_{SNS2}) +1.0V to +3.3V
 Junction Temperature Range (T_J) -40°C ≤ T_J ≤ +125°C
 Thermal Resistance
 3mm x 4mm MLF-20 (θ_{JA}) 53°C/W

Electrical Characteristics⁽⁴⁾

T_A = 25°C; AV_{IN1,2} = V_{IN1,2} = V_{EN1,2} = 3.6V; L_{1,2} = 1.0μH; C_{OUT1,2} = 4.7μF unless otherwise specified.

Bold values indicate -40°C ≤ T_J ≤ +125°C, unless noted.

Parameter	Condition	Min.	Typ.	Max.	Units
Supply Voltage Range		2.7		5.5	V
Undervoltage Lockout Threshold	Rising	2.45	2.55	2.65	V
Undervoltage Lockout Hysteresis			75		mV
Quiescent Current	I _{OUT} = 0mA, SNS > 1.2 * V _{OUTNOM} (both outputs)		45	90	μA
Shutdown Current	V _{EN} = 0V; V _{IN} = 5.5V (per output)		0.1	5	μA
Feedback Regulation Voltage	I _{OUT} = 20mA	0.6045	0.62	0.6355	V
Feedback Bias Current	(per output)		0.01		μA
Current Limit	SNS = 0.9 * V _{OUTNOM}	2.2	4.3		A
Output Voltage Line Regulation	V _{IN} = 3.6V to 5.5V if V _{OUTNOM} < 2.5V, I _{OUT} = 20mA		0.45		%/V
	V _{IN} = 4.5V to 5.5V if V _{OUTNOM} ≥ 2.5V, I _{OUT} = 20mA				
Output Voltage Load Regulation	DCM, V _{IN} = 3.6V if V _{OUTNOM} < 2.5V		0.55		%
	DCM, V _{IN} = 5.0V if V _{OUTNOM} ≥ 2.5V		1.0		
	CCM, V _{IN} = 3.6V if V _{OUTNOM} < 2.5V		0.8		
	CCM, V _{IN} = 5.0V if V _{OUTNOM} ≥ 2.5V				
PWM Switch R _{DS(on)}	I _{SW1,2} = 100mA PMOS		0.20		Ω
	I _{SW1,2} = -100mA NMOS		0.19		
Switching Frequency	I _{OUT} = 180mA		3		MHz
Soft-Start Time	V _{OUT} = 90%, C _{SS} = 470pF		300		μs
Soft-Start Current	V _{SS} = 0V		2.7		μA
Power Good Threshold (Rising)		86	92	96	%
Power Good Threshold Hysteresis			7		%
Power Good Delay Time	Rising		68		μs
Power Good Pull-Down Resistance			95		Ω

Notes:

- Exceeding the absolute maximum rating may damage the device.
- The device is not guaranteed to function outside its operating rating.
- Devices are ESD sensitive. Handling precautions recommended. Human body model, 1.5kΩ in series with 100pF.
- Specification for packaged product only.

Electrical Characteristics⁽⁴⁾ (Continued)

$T_A = 25^\circ\text{C}$; $AV_{IN1,2} = V_{IN1,2} = V_{EN1,2} = 3.6\text{V}$; $L_{1,2} = 1.0\mu\text{H}$; $C_{OUT1,2} = 4.7\mu\text{F}$ unless otherwise specified.

Bold values indicate $-40^\circ\text{C} \leq T_J \leq +125^\circ\text{C}$, unless noted.

Parameter	Condition	Min.	Typ.	Max.	Units
Enable Input Voltage	Logic Low			0.4	V
	Logic High	1.2			
Enable Input Current			0.1	2	μA
Output Discharge Resistance	MIC23159 Only; EN = 0V, $I_{OUT} = 250\mu\text{A}$		225		Ω
Overtemperature Shutdown			160		$^\circ\text{C}$
Shutdown Hysteresis			20		$^\circ\text{C}$

Typical Characteristics

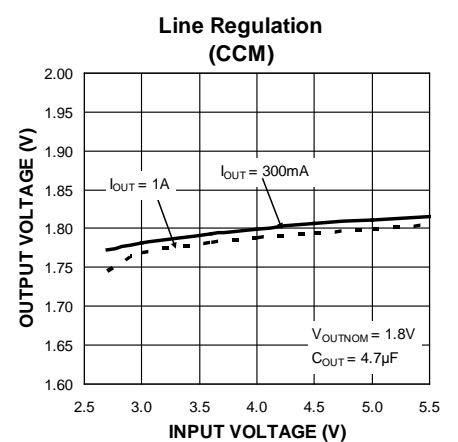
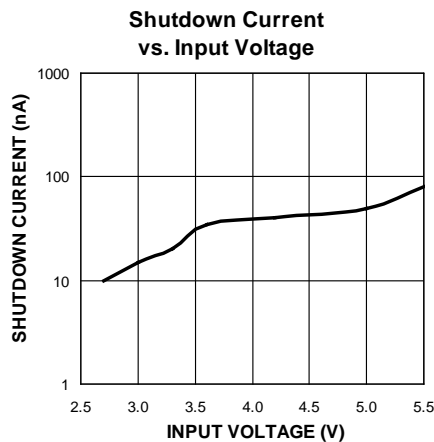
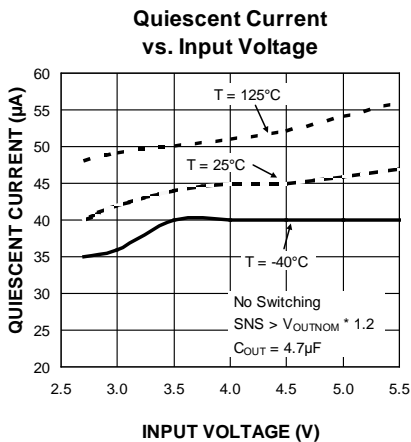
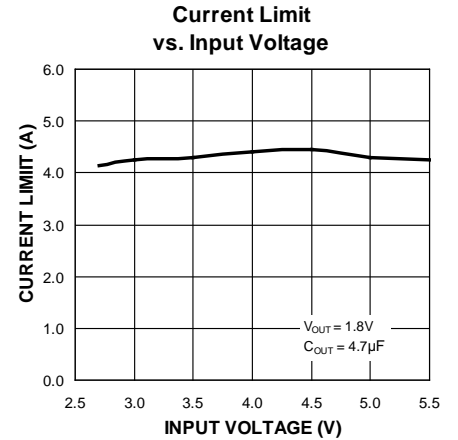
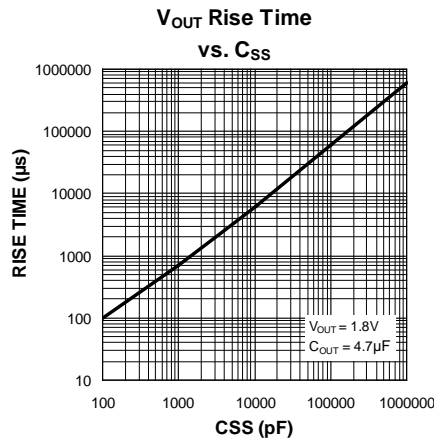
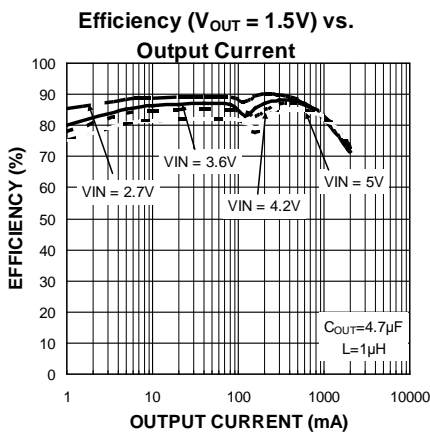
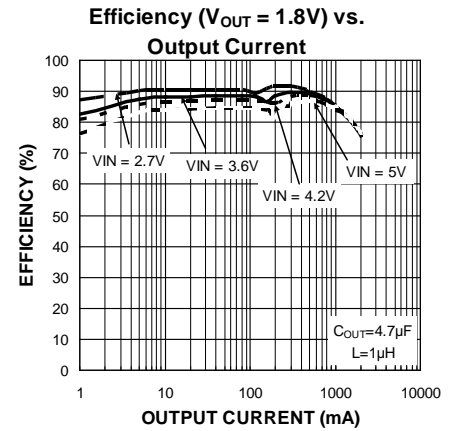
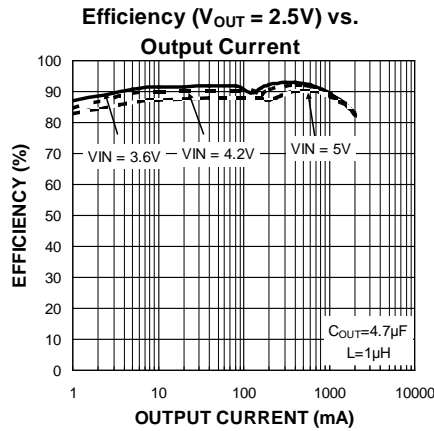
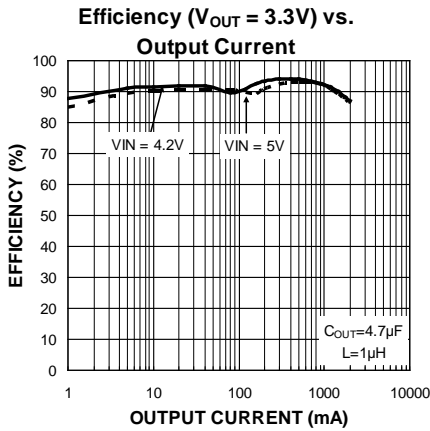

Typical Characteristics (Continued)

Line Regulation (HLL)

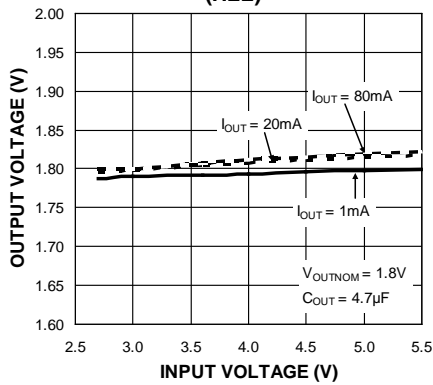

Load Regulation (CCM)

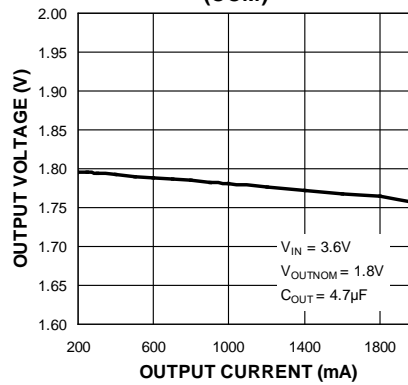

Load Regulation (HLL)

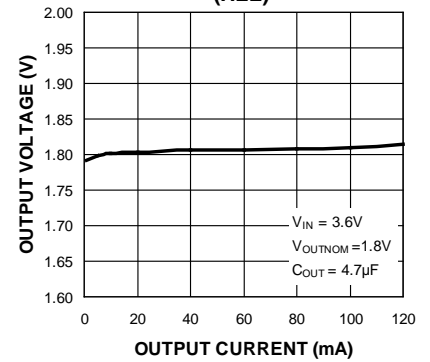

V_{OUTMAX} vs. V_{IN}

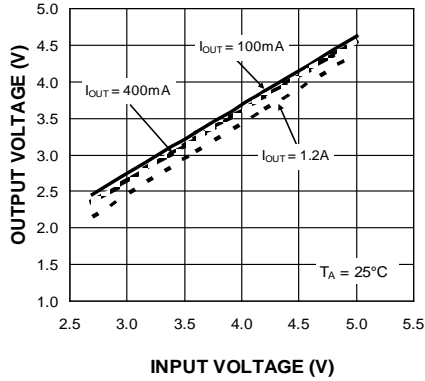

Feedback Voltage vs. Temperature

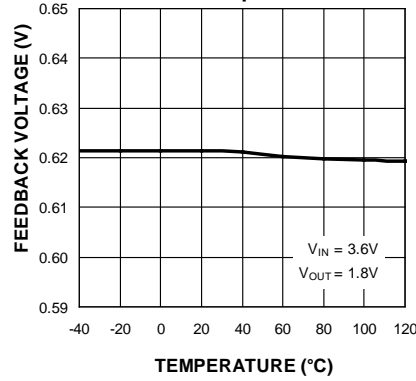

Switching Frequency vs. Temperature

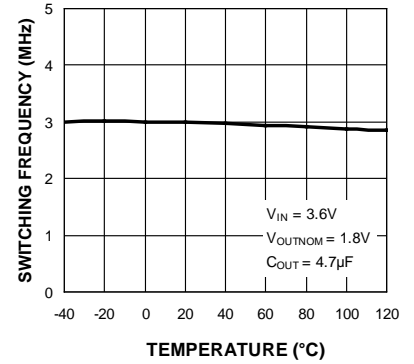

Functional Characteristics

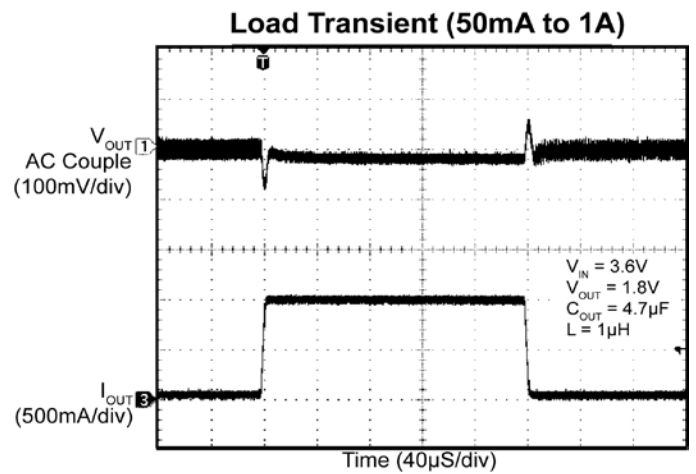
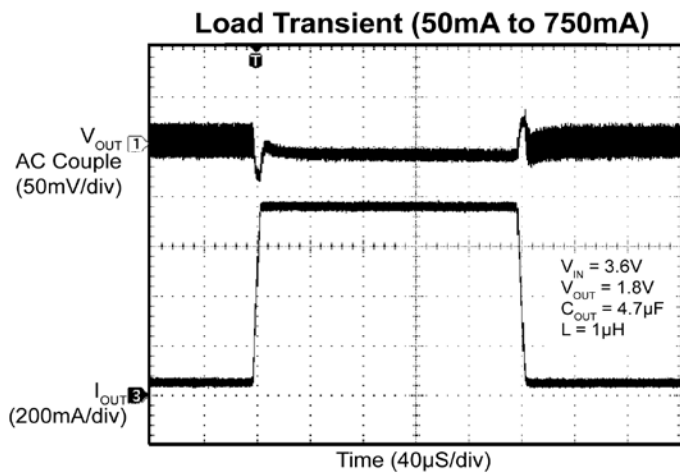
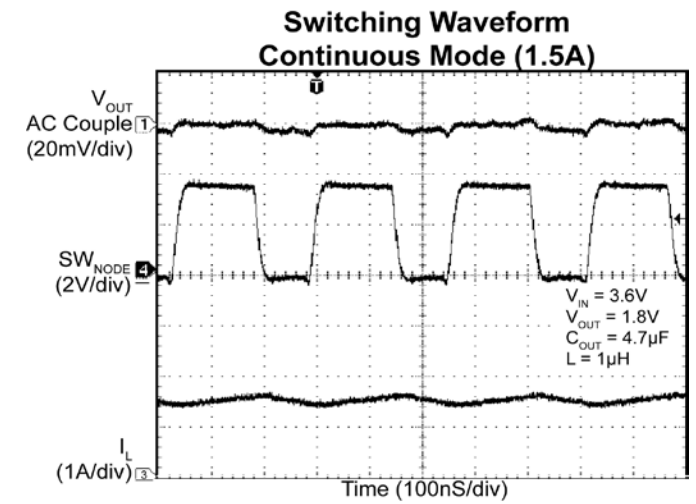
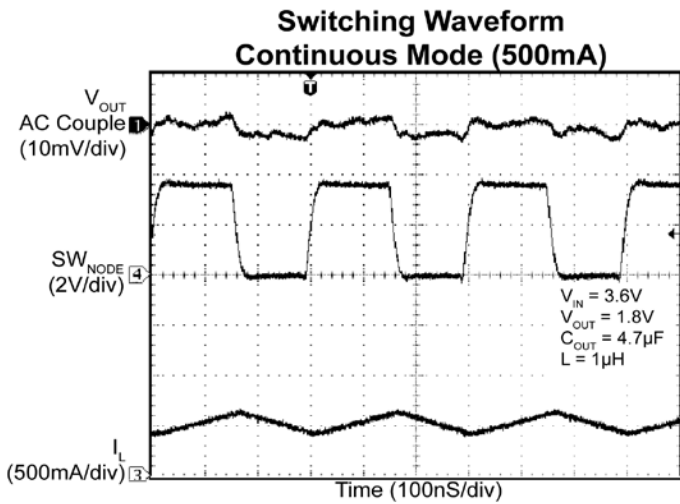
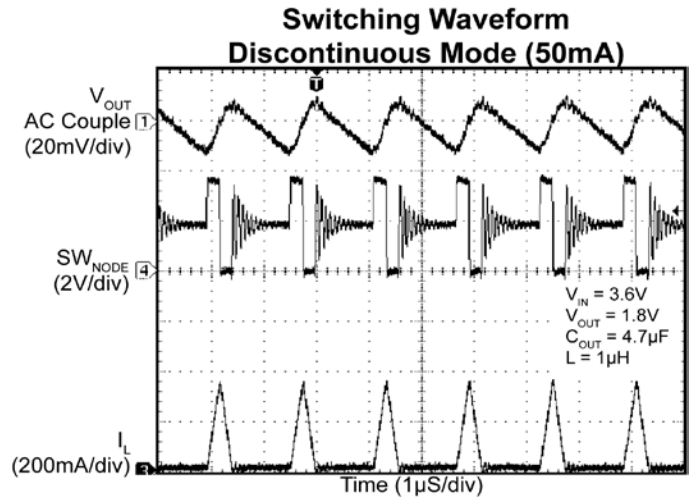
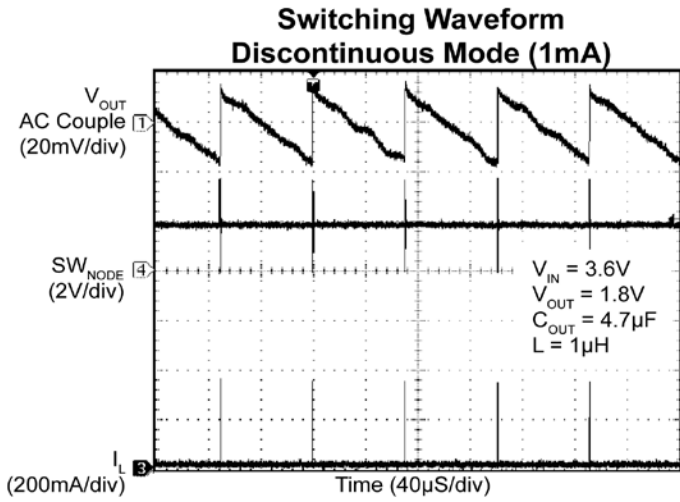

Functional Characteristics (Continued)

Load Transient (200mA to 600mA)

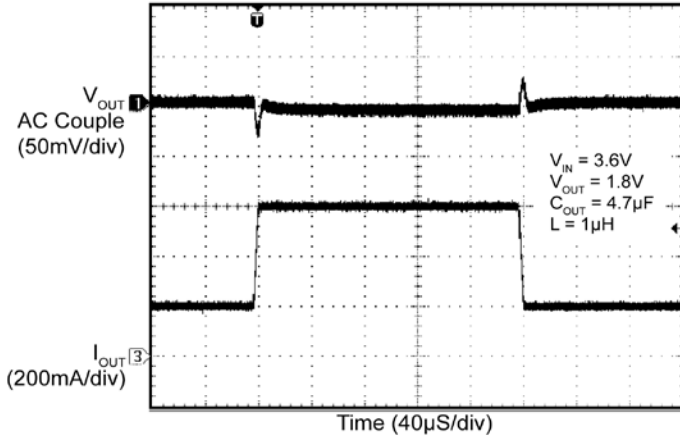

Load Transient (200mA to 1A)

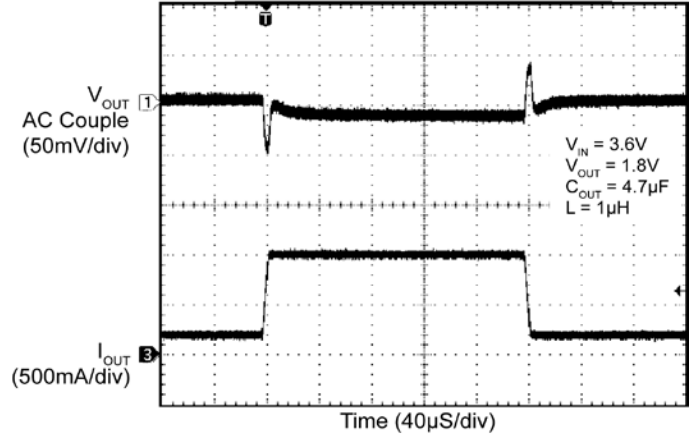

Load Transient (200mA to 1.5A)

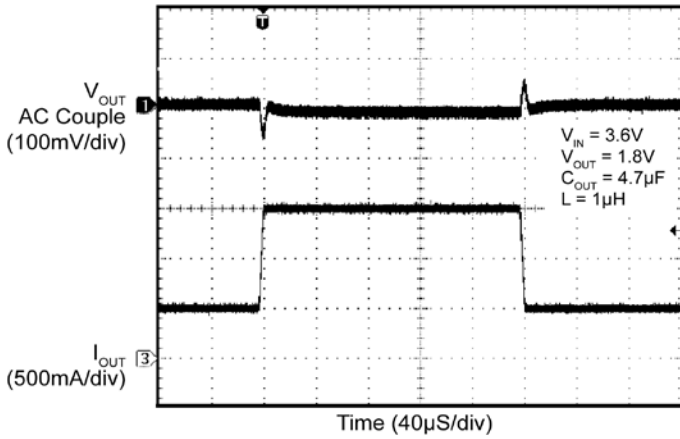

Line Transient (3.6V to 5.5V at 1.5A)

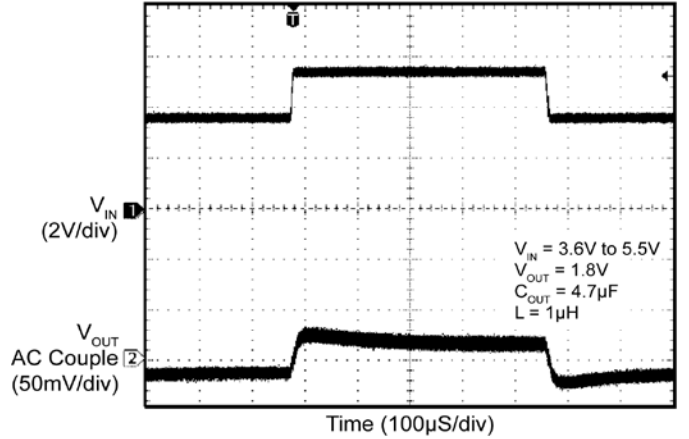

Power Good Load Transient (200mA to 1.5A)

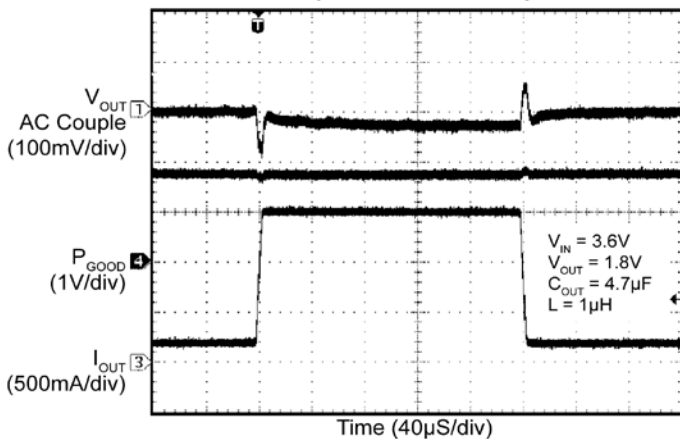

Power Good during Line Transient (3.6V to 5.5V at 1.5A)

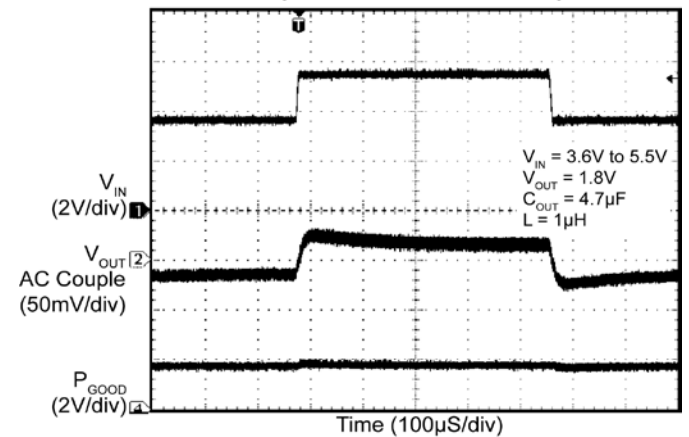

Functional Characteristics (Continued)

Power Good during Startup

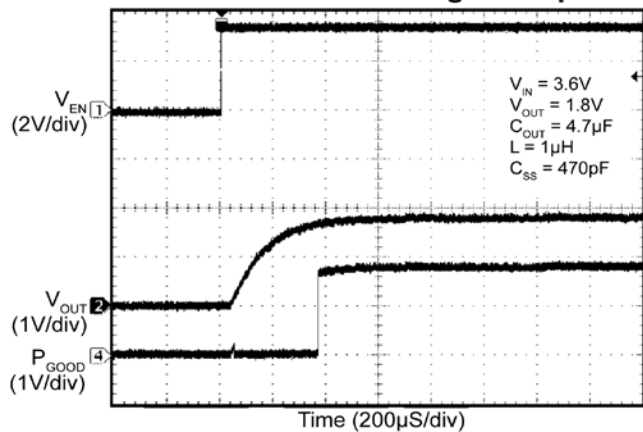

Power Good during Shutdown (MIC23159)

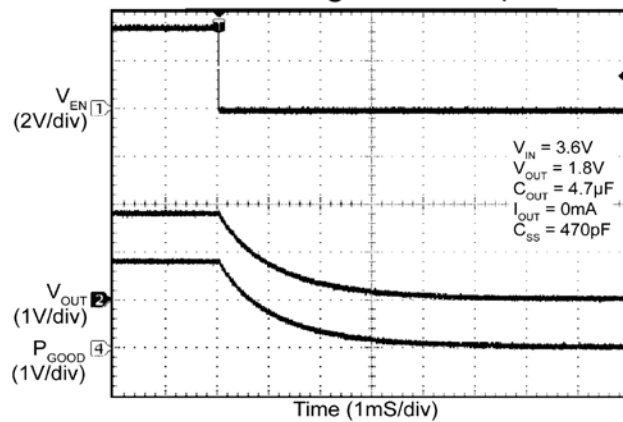

Functional Description

VIN

The input supply (VIN) provides power to the internal MOSFETs for the switch mode regulator section. The VIN operating range is 2.7V to 5.5V. An input capacitor with a minimum voltage rating of 6.3V is recommended. Due to the high switching speed, a minimum 2.2μF bypass capacitor placed close to VIN and the power ground (PGND) pin is required. Refer to the *PCB Layout Recommendations* for details.

AVIN

Analog VIN (AVIN) provides power to the internal control and analog supply circuitry. AVIN and VIN must be tied together. Careful layout should be considered to ensure high frequency switching noise caused by VIN is reduced before reaching AVIN. A 1μF capacitor as close to AVIN as possible is recommended. Refer to the *PCB Layout Recommendations* for details.

EN

A logic high signal on the enable pin activates the output voltage of the device. A logic low signal on the enable pin deactivates the output and reduces supply current to 0.1μA. Do not leave the EN pin floating. When disabled, the MIC23159 switches in a 225Ω load from the SNS pin to AGND, to discharge the output capacitor.

SW

The switch (SW) connects directly to one end of the inductor and provides the current path during switching cycles. The other end of the inductor is connected to the load, SNS pin, and output capacitor. Due to the high speed switching on this pin, the switch node should be routed away from sensitive nodes whenever possible.

SNS

The sense (SNS) pin is connected to the output of the device to provide feedback to the control circuitry. The SNS connection should be placed close to the output capacitor. Refer to the layout recommendations for more details. The SNS pin also provides the output active discharge circuit path to pull down the output voltage when the device is disabled.

AGND

The analog ground (AGND) is the ground path for the biasing and control circuitry. The current loop for the signal ground should be separate from the power ground (PGND) loop. Refer to the *PCB Layout Recommendations* for details.

PGND

The power ground pin is the ground path for the high current in PWM mode. The current loop for the power ground should be as small as possible and separate from the analog ground (AGND) loop as applicable. Refer to the layout recommendations for more details.

PG

The power good (PG) pin is an open drain output which indicates when the output voltage is within regulation. This is indicated by a logic high signal when the output voltage is above the PG threshold. Connect a pull up resistor greater than 5kΩ from PG to V_{OUT}.

SS

An external soft start circuitry set by a capacitor on the SS pin reduces inrush current and prevents the output voltage from overshooting at start up. The SS pin is used to control the output voltage ramp up time and the approximate equation for the ramp time in milliseconds is $296 \times 10^3 \times \ln(10) \times C_{SS}$. For example, for a $C_{SS} = 470\text{pF}$, $T_{RISE} \approx 300\mu\text{s}$. Refer to the “V_{OUT} Rise Time vs. C_{SS}” graph in the *Typical Characteristics* section. The minimum recommended value for C_{SS} is 200pF.

FB

The feedback (FB) pin is provided for the adjustable voltage option. This is the control input for setting the output voltage. A resistor divider network is connected to this pin from the output and is compared to the internal 0.62V reference within the regulation loop.

The output voltage can be calculated using Equation 1:

$$V_{OUT} = V_{REF} \cdot \left(1 + \frac{R1}{R2}\right) \quad \text{Eq. 1}$$

Recommended feedback resistor values:

V _{OUT}	R1	R2
1.2V	274k	294k
1.5V	316k	221k
1.8V	301k	158k
2.5V	324k	107k
3.3V	309k	71.5k

Application Information

The MIC23158/9 is a high-performance DC/DC step down regulator offering a small solution size. Supporting two outputs of up to 2A each in a 3mm x 4mm MLF package. Using the HyperLight Load switching scheme, the MIC23158/9 is able to maintain high efficiency throughout the entire load range while providing ultra fast load transient response. The following sections provide additional device application information.

Input Capacitor

A 2.2µF ceramic capacitor or greater should be placed close to the VIN pin and PGND pin for bypassing. A Murata GRM188R60J475KE19D, size 0603, 4.7µF ceramic capacitor is recommended based upon performance, size and cost. A X5R or X7R temperature rating is recommended for the input capacitor.

Output Capacitor

The MIC23158/9 is designed for use with a 2.2µF or greater ceramic output capacitor. Increasing the output capacitance will lower output ripple and improve load transient response but could also increase solution size or cost. A low equivalent series resistance (ESR) ceramic output capacitor such as the Murata GRM188R60J475KE19D, size 0603, 4.7µF ceramic capacitor is recommended based upon performance, size and cost. Both the X7R or X5R temperature rating capacitors are recommended.

Inductor Selection

When selecting an inductor, it is important to consider the following factors:

- Inductance
- Rated current value
- Size requirements
- DC resistance (DCR)

The MIC23158/9 is designed for use with a 0.47µH to 2.2µH inductor. For faster transient response, a 0.47µH inductor will yield the best result. For lower output ripple, a 2.2µH inductor is recommended.

Maximum current ratings of the inductor are generally given in two methods; permissible DC current, and saturation current. Permissible DC current can be rated either for a 40°C temperature rise or a 10% to 20% loss in inductance. Ensure the inductor selected can handle the maximum operating current. When saturation current is specified, make sure that there is enough margin so that the peak current does not cause the inductor to saturate.

Peak current can be calculated in Equation 2:

$$I_{PEAK} = \left[I_{OUT} + V_{OUT} \left(\frac{1 - V_{OUT}/V_{IN}}{2 \times f \times L} \right) \right] \quad \text{Eq. 2}$$

As shown by the calculation above, the peak inductor current is inversely proportional to the switching frequency and the inductance. The lower the switching frequency or inductance, the higher the peak current. As input voltage increases, the peak current also increases.

The size of the inductor depends on the requirements of the application. Refer to the typical application circuit and *Bill of Materials* for details.

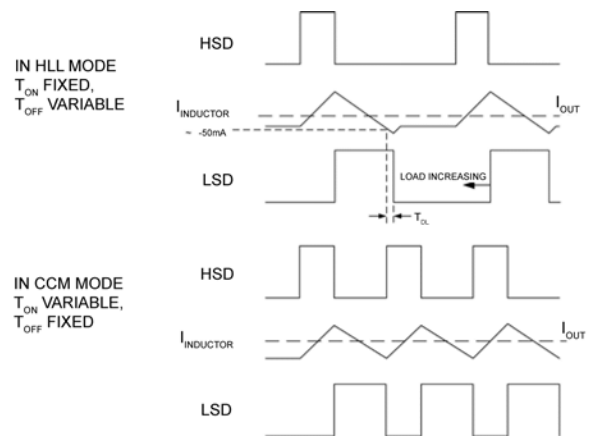

Figure 3. Transition between CCM Mode to HLL Mode

DC resistance (DCR) is also important. While DCR is inversely proportional to size, DCR can represent a significant efficiency loss. Refer to the “Efficiency Considerations” subsection.

The transition between continuous conduction mode (CCM) to HyperLight Load mode is determined by the inductor ripple current and the load current.

The diagram shows the signals for high-side switch drive (HSD) for T_{ON} control, the Inductor current, and the low-side switch drive (LSD) for T_{OFF} control.

In HLL mode, the inductor is charged with a fixed T_{ON} pulse on the high side switch. After this, the low side switch is turned on and current falls at a rate V_{OUT}/L. The controller remains in HLL mode while the inductor falling current is detected to cross approximately -50mA. When the LSD (or T_{OFF}) time reaches its minimum and the inductor falling current is no longer able to reach the threshold, the part is in CCM mode.

Once in CCM mode, the T_{OFF} time will not vary. Therefore, it is important to note that if L is large enough, the HLL transition level will not be triggered.

That inductor is illustrated in Figure 3:

$$L_{MAX} = \frac{V_{OUT} - 135ns}{2 - 50mA} \quad \text{Eq. 3}$$

Duty Cycle

The typical maximum duty cycle of the MIC23158/9 is 80%.

Efficiency Considerations

Efficiency is defined as the amount of useful output power, divided by the amount of power supplied.

$$\text{Efficiency \%} = \left(\frac{V_{OUT} \times I_{OUT}}{V_{IN} \times I_{IN}} \right) \times 100 \quad \text{Eq. 4}$$

There are two types of losses in switching converters; DC losses and switching losses. DC losses are simply the power dissipation of I^2R . Power is dissipated in the high side switch during the on cycle. Power loss is equal to the high side MOSFET R_{DSON} multiplied by the switch current squared. During the off cycle, the low side N-channel MOSFET conducts, also dissipating power. Device operating current also reduces efficiency. The product of the quiescent (operating) current and the supply voltage represents another DC loss. The current required driving the gates on and off at a constant 3MHz frequency and the switching transitions make up the switching losses.

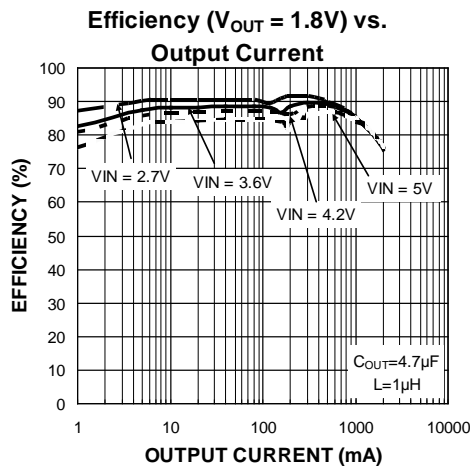

Figure 4. Efficiency under Load

Figure 4 shows an efficiency curve. From 1mA load to 2A, efficiency losses are dominated by quiescent current losses, gate drive and transition losses. By using the HyperLight Load mode, the MIC23158/9 is able to maintain high efficiency at low output currents.

Over 180mA, efficiency loss is dominated by MOSFET R_{DSON} and inductor losses. Higher input supply voltages will increase the gate-to-source threshold on the internal MOSFETs, thereby reducing the internal R_{DSON} . This improves efficiency by reducing DC losses in the device. All but the inductor losses are inherent to the device. In which case, inductor selection becomes increasingly critical in efficiency calculations. As the inductors are reduced in size, the DC resistance (DCR) can become quite significant. The DCR losses can be calculated as in Equation 5:

$$P_{DCR} = I_{OUT}^2 \times DCR \quad \text{Eq. 5}$$

From that, the loss in efficiency due to inductor resistance can be calculated as in Equation 6:

$$\text{Efficiency Loss} = \left[1 - \left(\frac{V_{OUT} \times I_{OUT}}{V_{OUT} \times I_{OUT} + P_{DCR}} \right) \right] \times 100 \quad \text{Eq. 6}$$

Efficiency loss due to DCR is minimal at light loads and gains significance as the load is increased. Inductor selection becomes a trade off between efficiency and size in this case.

HyperLight Load Mode

The MIC23158/9 uses a minimum on and off time proprietary control loop (patented by Micrel). When the output voltage falls below the regulation threshold, the error comparator begins a switching cycle that turns the PMOS on and keeps it on for the duration of the minimum-on-time. This increases the output voltage. If the output voltage is over the regulation threshold, then the error comparator turns the PMOS off for a minimum-off-time until the output drops below the threshold. The NMOS acts as an ideal rectifier that conducts when the PMOS is off. Using an NMOS switch instead of a diode allows for lower voltage drop across the switching device when it is on. The synchronous switching combination between the PMOS and the NMOS allows the control loop to work in discontinuous mode for light load operations. In discontinuous mode, the MIC23158/9 works in HyperLight Load to regulate the output. As the output current increases, the off time decreases, thus provides more energy to the output. This switching scheme improves the efficiency of MIC23158/9 during light load currents by only switching when it is needed.

As the load current increases, the MIC23158/9 goes into continuous conduction mode (CCM) and switches at a frequency centered at 3MHz. The equation to calculate the load when the MIC23158/9 goes into continuous conduction mode may be approximated by the following formula:

$$I_{LOAD} > \left(\frac{(V_{IN} - V_{OUT}) \times D}{2L \times f} \right) \quad \text{Eq. 7}$$

As shown in Equation 7, the load at which the MIC23158/9 transitions from HyperLight Load mode to PWM mode is a function of the input voltage (V_{IN}), output voltage (V_{OUT}), duty cycle (D), inductance (L) and frequency (f). As shown in Figure 5, as the output current increases, the switching frequency also increases until the MIC23158/9 goes from HyperLight Load mode to PWM mode at approximately 180mA. The MIC23158/9 will switch at a relatively constant frequency around 3MHz once the output current is over 180mA.

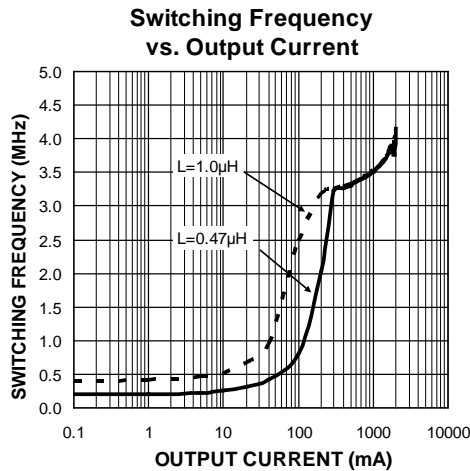
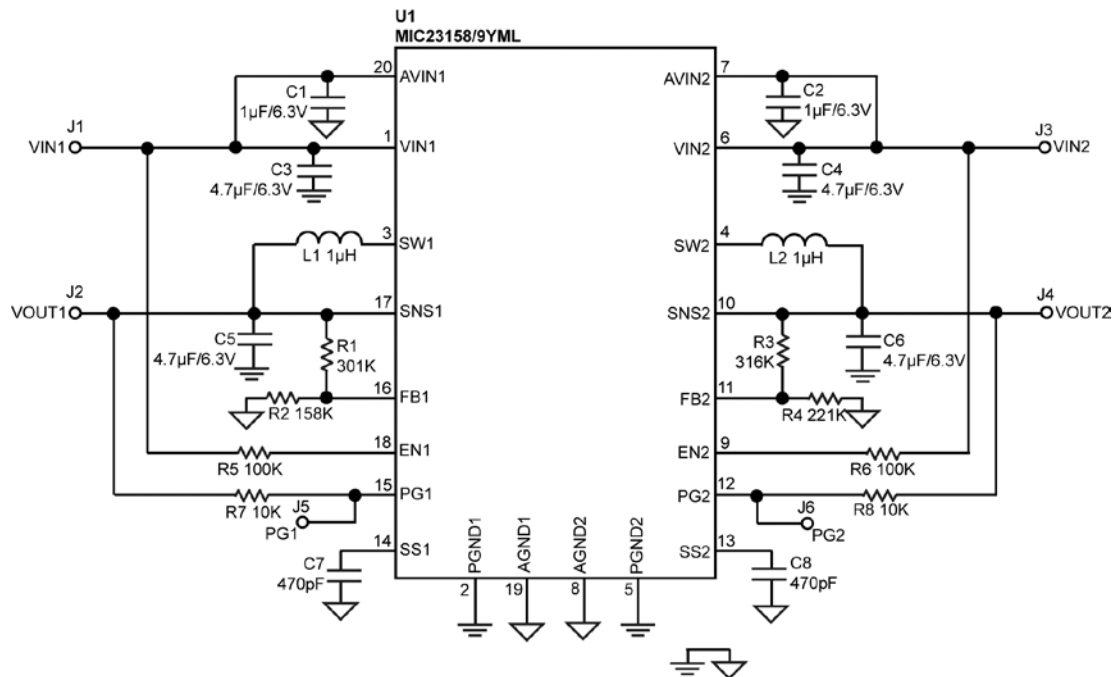

Figure 5. SW Frequency vs. Output Current

Typical Application Circuit (Adjustable Output)



Bill of Materials

Item	Part Name	Manufacturer	Description	Qty.
C1, C2	06036D105KAT2A	AVX ⁽¹⁾	1μF, 0603, 6.3V	2
	GRM188R60J105KA01D	Murata ⁽²⁾		
	C1608X5R0J105K	TDK ⁽³⁾		
C3, C4, C5, C6	06036D475KAT2A	AVX	4.7μF, 6.3V, X5R, 0603	4
	GRM188R60J475KE19D	Murata		
	C1608X5R0J475K	TDK		
C7, C8	06035A471JAT2A	AVX	470pF, 50V, 0603	2
	GRM1885C1H471JA01D	Murata		
	C1608C0G1H471J	TDK		
L1, L2	CDRH4D28CLDNP-1R0P	SUMIDA ⁽⁴⁾	1μH, 3.0A, 14mΩ, L5.1mm x W5.1mm x H3.0mm	2
	LQH44PN1R0NJ0	MURATA	1μH, 2.8A, 14mΩ, L5.1mm x W5.1mm x H3.0mm	
R1	CRCW06033013FKEA	Vishay/Dale ⁽⁵⁾	301KΩ, 1%, 1/10W, 0603	1
R2	CRCW06031583FKEA	Vishay/Dale	158KΩ, 1%, 1/10W, 0603	1
R3	CRCW06033163FKEA	Vishay/Dale	316KΩ, 1%, 1/10W, 0603	1
R4	CRCW06032213FKEA	Vishay/Dale	221KΩ, 1%, 1/10W, 0603	1
R5, R6	CRCW06031003FKEA	Vishay/Dale	100KΩ, 1%, 1/10W, 0603	2
R7, R8	CRCW06031002FKEA	Vishay/Dale	10KΩ, 1%, 1/10W, 0603	2
U1	MIC23158/9YML	Micrel, Inc ⁽⁶⁾	3MHz PWM Dual 2A Buck Regulator with HyperLight Load and Power Good	1

Notes:

1. AVX: www.avx.com.
2. Murata: www.murata.com.
3. TDK: www.tdk.com.
4. Sumida: www.sumida.com.
5. Vishay/Dale: www.vishay.com.
6. Micrel, Inc.: www.micrel.com.

PCB Layout Recommendations

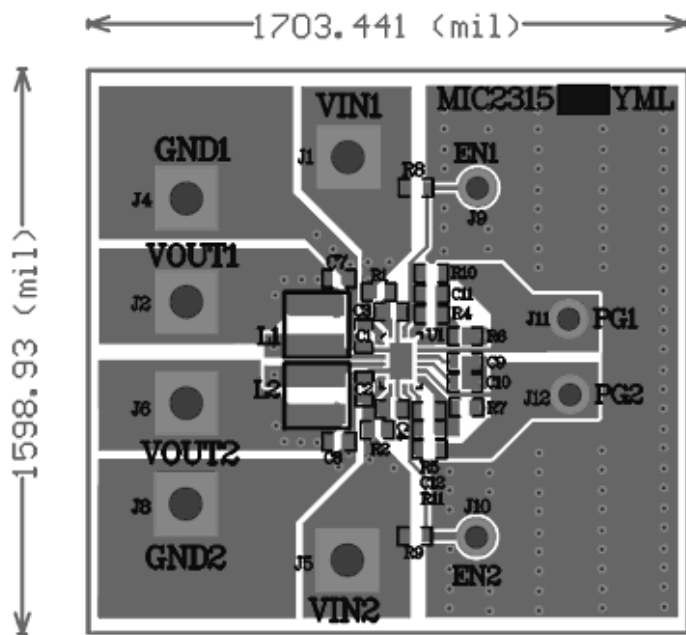

Top Layer

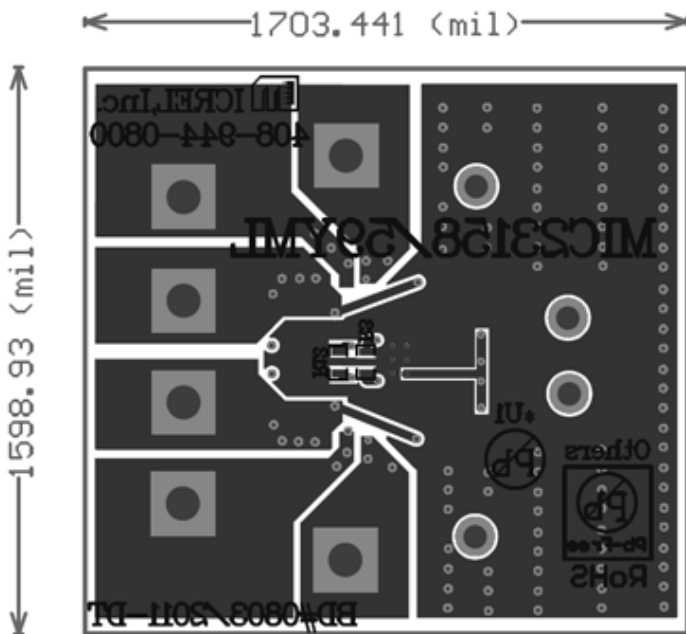

Bottom Layer

Package Information⁽¹⁾

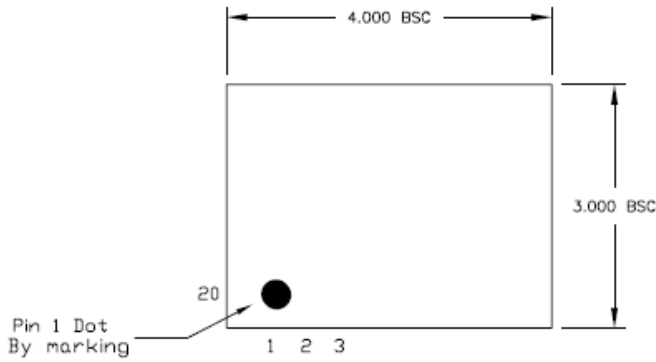

TOP VIEW

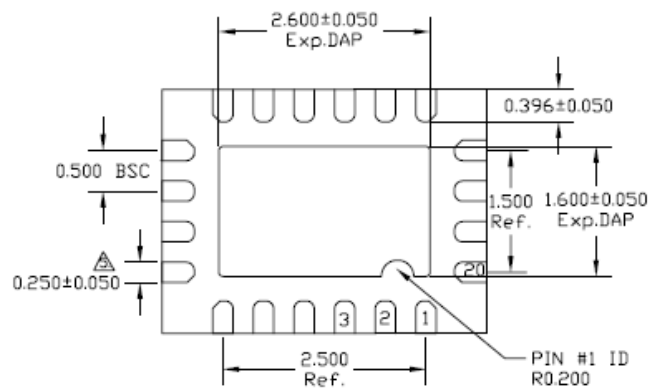

BOTTOM VIEW

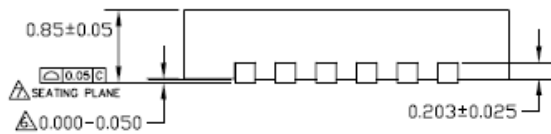

SIDE VIEW

NOTE:

1. ALL DIMENSIONS ARE IN MILLIMETERS.
2. MAX. PACKAGE WARPAGE IS 0.05 mm.
3. MAXIMUM ALLOWABLE BURRS IS 0.076 mm IN ALL DIRECTIONS.
4. PIN #1 ID ON TOP WILL BE LASER/INK MARKED.
5. DIMENSION APPLIES TO METALIZED TERMINAL AND IS MEASURED BETWEEN 0.20 AND 0.25 mm FROM TERMINAL TIP.
6. APPLIED ONLY FOR TERMINALS.
7. APPLIED FOR EXPOSED PAD AND TERMINALS.

20-Pin 3mm x 4mm MLF

Note:

1. Package information is correct as of the publication date. For updates and most current information, go to www.micrel.com.

Recommended Land Pattern

LP # MLF34D-20LD-LP-1
 All units are in mm
 Tolerance ± 0.05 if not noted

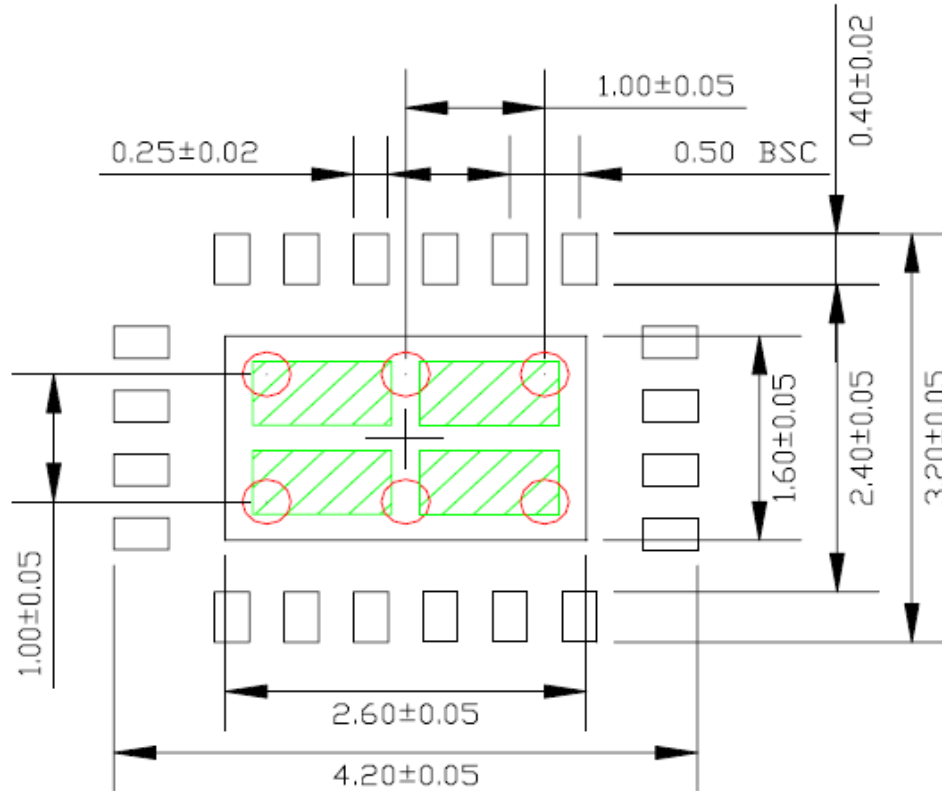

Red circle indicates Thermal Via. Size should be .300-.350 mm in diameter, 1.00 mm pitch and should be connected to GND plane for maximum thermal performance.

Green rectangle (with shaded area) indicates Solder Stencil Opening on exposed pad area. Size should be 1.00x0.50 mm in size, 0.70 mm pitch.

MICREL, INC. 2180 FORTUNE DRIVE SAN JOSE, CA 95131 USA
 TEL +1 (408) 944-0800 FAX +1 (408) 474-1000 WEB <http://www.micrel.com>

Micrel makes no representations or warranties with respect to the accuracy or completeness of the information furnished in this data sheet. This information is not intended as a warranty and Micrel does not assume responsibility for its use. Micrel reserves the right to change circuitry, specifications and descriptions at any time without notice. No license, whether express, implied, arising by estoppel or otherwise, to any intellectual property rights is granted by this document. Except as provided in Micrel's terms and conditions of sale for such products, Micrel assumes no liability whatsoever, and Micrel disclaims any express or implied warranty relating to the sale and/or use of Micrel products including liability or warranties relating to fitness for a particular purpose, merchantability, or infringement of any patent, copyright or other intellectual property right.

Micrel Products are not designed or authorized for use as components in life support appliances, devices or systems where malfunction of a product can reasonably be expected to result in personal injury. Life support devices or systems are devices or systems that (a) are intended for surgical implant into the body or (b) support or sustain life, and whose failure to perform can be reasonably expected to result in a significant injury to the user. A Purchaser's use or sale of Micrel Products for use in life support appliances, devices or systems is a Purchaser's own risk and Purchaser agrees to fully indemnify Micrel for any damages resulting from such use or sale.

© 2012 Micrel, Incorporated.