

MGA-64606

Low Noise Amplifier with switchable Bypass/Shutdown Mode in Low Profile Package



Data Sheet

Description

Avago Technologies' MGA-64606 is an economical, easy-to-use GaAs MMIC Low Noise Amplifier (LNA) with Bypass/Shutdown mode. The LNA has low noise and high linearity achieved through the use of Avago Technologies' proprietary 0.25 μm GaAs Enhancement-mode pHEMT process. The Bypass/Shutdown mode enables the LNA to be bypassed during high input signal power and reduce current consumption. It is housed in a low profile 2.0 x 1.3 x 0.5mm³ 6-pin Ultra Thin Package. The compact footprint and low profile coupled with low noise, high linearity make the MGA-64606 an ideal choice as a low noise amplifier for mobile receiver in the WiMAX, WLAN(802.11b/g), WiBro and DMB applications.

Component Image

2.0 x 1.3 x 0.5 mm³ 6-lead Ultra Thin Package

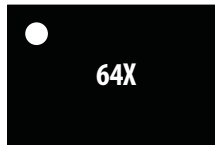

Note:
Package marking provides orientation and identification
"64" = Product Code
"X" = Month Code

Pin Configuration

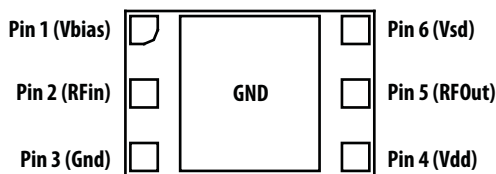

TOP VIEW

 **Attention: Observe precautions for handling electrostatic sensitive devices.**
ESD Machine Model = 60 V
ESD Human Body Model = 300 V
Refer to Avago Application Note A004R: Electrostatic Discharge, Damage and Control.

Features

- Low current consumption
- Adjustable bias current
- 1.5 GHz – 3 GHz operating range
- Low Noise Figure
- Low current consumption in Bypass Mode, <100 μA
- Fully matched to 50 ohm in Bypass Mode
- High Linearity (LNA and Bypass Mode)
- Low profile package

Typical Performance

2.4 GHz; 3V, 7mA (Typ):

- 15.3 dB Gain
- 0.95 dB Noise Figure
- +5.0 dBm Input IP3
- -3.0 dBm Input Power at 1 dB gain compression
- 3.8 dB Insertion Loss in Bypass Mode
- 12 dBm IIP3 in Bypass Mode (Pin = -20 dBm)
- <100 μA current consumption in Bypass mode

Applications

- Low noise amplifier for GPS, WiMAX, WLAN, WiBro and DMB applications.
- Other ultra low noise applications in the 1.5 – 3 GHz band.

Simplified Schematic

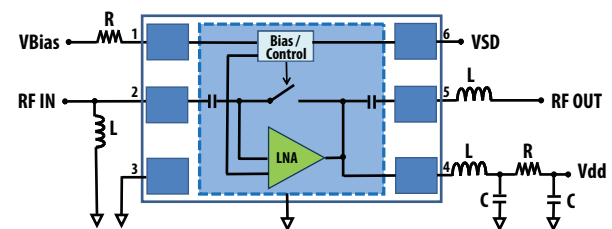

Absolute Maximum Rating ^[1] T_A = 25° C

Symbol	Parameter	Units	Absolute Maximum
V _{dd}	Device Voltage, RF Output to Ground	V	5
V _{bias}	Control Voltage	V	(V _{dd} -0.3)
P _{in,max}	CW RF Input Power	dBm	+12
P _{diss}	Total Power Dissipation	mW	94
T _j	Junction Temperature	°C	150
T _{STG}	Storage Temperature	°C	-65 to 150

Thermal Resistance

Thermal Resistance ^[2,3]
 (V_{dd} = 3.0 V, I_d = 7 mA),
 θ_{jc} = 60° C/W

Notes:

1. Operation of this device in excess of any of these limits may cause permanent damage.
2. Thermal resistance measured using Infra-Red Measurement Technique.
3. Board temperature (T_b) is 25° C. For T_b > 146° C, derate the device power at 14 mW per °C rise in Board (package belly) temperature.

Product Consistency Distribution charts ^[1]

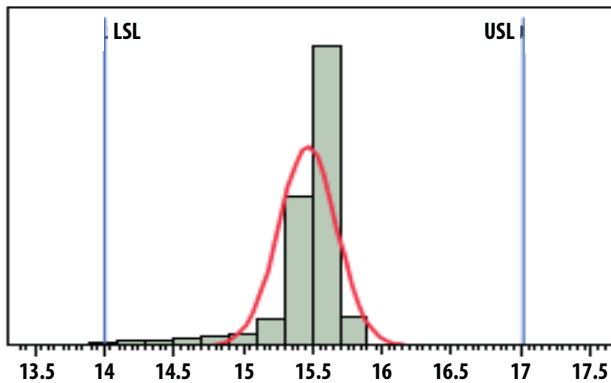

Figure 1. Gain @ 2.4 GHz, V_{dd} 3 V; V_{bias} 1.8 V
 LSL = 14.3 dB, Nominal = 15.3 dB, USL = 16.7 dB

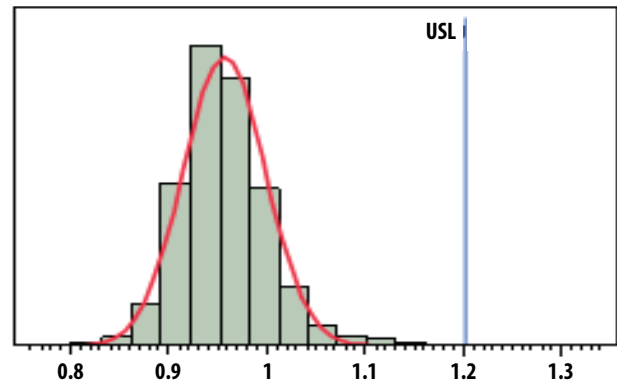

Figure 2. NF @ 2.4 GHz, V_{dd} 3 V; V_{bias} 1.8 V
 Nominal = 0.95 dB, USL = 1.2 dB

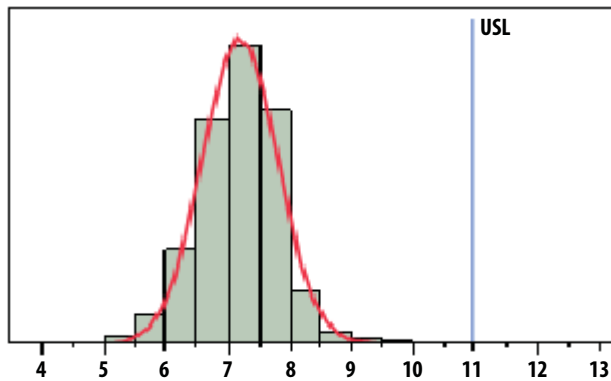

Figure 3. I_{dd} @ 2.4 GHz, V_{dd} 3 V; V_{bias} 1.8 V
 Nominal = 7.0 mA, USL = 10.0 mA

Note:

1. Distribution data sample size is 3000 samples taken from 3 different wafers and 3 different lots. Future wafers allocated to this product may have nominal values anywhere between the upper and lower limits.

Electrical Specifications [1]

$T_A = 25^\circ\text{C}$, $V_{dd} = 3\text{ V}$, $V_{bias} = 1.8\text{ V}$, RF measurement at 2.4 GHz – Typical Performance. See Fig 4 and Fig 6 for demo board and schematic.

Symbol	Parameter and Test Condition	Units	Min.	Typ.	Max.
LNA Mode performance ($V_{dd} = 3\text{ V}$, $V_{bias} = 1.8\text{ V}$ & $V_{SD} = 0\text{ V}$)					
I _{dd}	Bias Current	mA	–	7	11
Gain	Gain	dB	14	15.3	17
NF	Noise Figure	dB	–	0.95	1.2
IIP3	Input Third Order Intercept Point	dBm	–	+5.0	–
IP1dB	Input Power at 1 dB Gain Compression	dBm	–	-3.0	–
S11	Input Return Loss, 50 Ω source	dB	–	-11	–
S22	Output Return Loss, 50 Ω load	dB	–	-12	–
S12	Reverse Isolation	dB	–	-23	–
BYPASS Mode performance ($V_{dd} = 3\text{ V}$, $V_{bias} = 0\text{ V}$ & $V_{SD} = 0\text{ V}$)					
S21 _{BYPASS}	Bypass Mode Insertion Loss	dB	–	3.8	–
IIP3 _{BYPASS}	Bypass Mode IIP3 (Tested at -20 dBm input Power)	dBm	–	12	–
I _{dd} _{BYPASS}	Bypass Mode Current	μA	–	65	–
Shutdown Mode performance ($V_{dd} = 3\text{ V}$, $V_{bias} = 0\text{ V}$ & $V_{SD} = 3\text{ V}$)					
S21 _{SHUTDOWN}	Shutdown Mode Isolation	dB	–	16	–
I _{dd} _{SHUTDOWN}	Shutdown Mode Current	μA	–	100	–

Note:

- 2.4 GHz IIP3 test condition: $F_{RF1} = 2.395\text{ GHz}$, $F_{RF2} = 2.4\text{ GHz}$ with input power of -30 dBm per tone.

Table 1. LNA Switch Truth Table

V _{bias} (V) / V _{sd} (V)	V _{dd} (V)	Mode
1.8 / 0 [1]	3	LNA
0 / 0 [2]	3	BYPASS
0 / 3 [3]	3	SHUTDOWN

Notes:

- Device operation in LNA mode if $V_{bias} > 1.5\text{ V}$ and $V_{SD} < 0.5\text{ V}$. Bias current of LNA can be varied with different values of V_{bias} for $V_{bias} > 1.5\text{ V}$. See Fig 5 below.
- Device operation in BYPASS mode if $V_{bias} < 0.3\text{ V}$ and $V_{SD} < 0.5\text{ V}$.
- Device is shutdown if $V_{sd} > 2.2\text{ V}$. In SHUTDOWN mode, LNA and internal Bypass switch is turned OFF. SHUTDOWN mode overrides V_{bias} voltage setting. Pin 6 (V_{sd}) is a Pull-Down logic function pin and recommend to ground it if shutdown function is not used in application.

Demo Board Layout

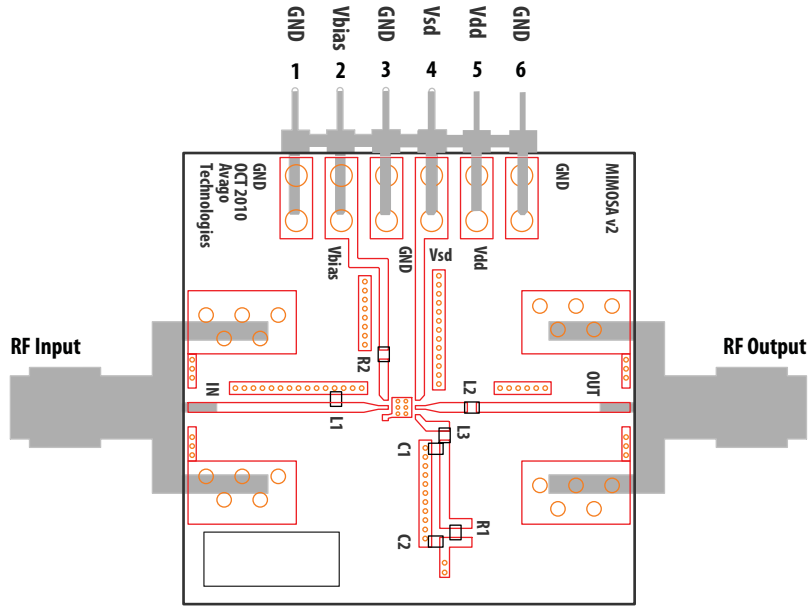

Figure 4. Demo Board Layout Diagram

Application Notes

1. Performance in a specified frequency band can be optimized by changing component values in the demo board above to suit the application at that frequency. The schematic on page 5 and 11 show two sets of components used to demonstrate performance at the (2.3 – 2.4) GHz Wibro band and (2.5 – 2.7) GHz WiMAX/DMB band.
2. Pin1 (Vbias pin) voltage in LNA mode can be varied to enable the LNA bias current to be adjusted, refer to next graph:

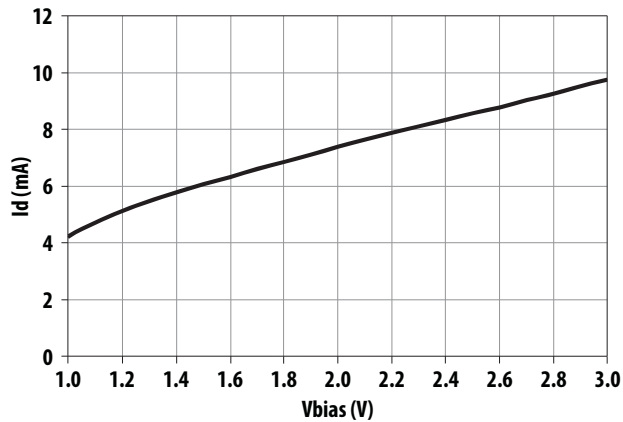

Figure 5. Id vs Vbias (Vdd = 3 V; Vsd = 0 V). Vbias is varies in this plot.

Demo Board Schematic for 2.3 – 2.4 GHz Application

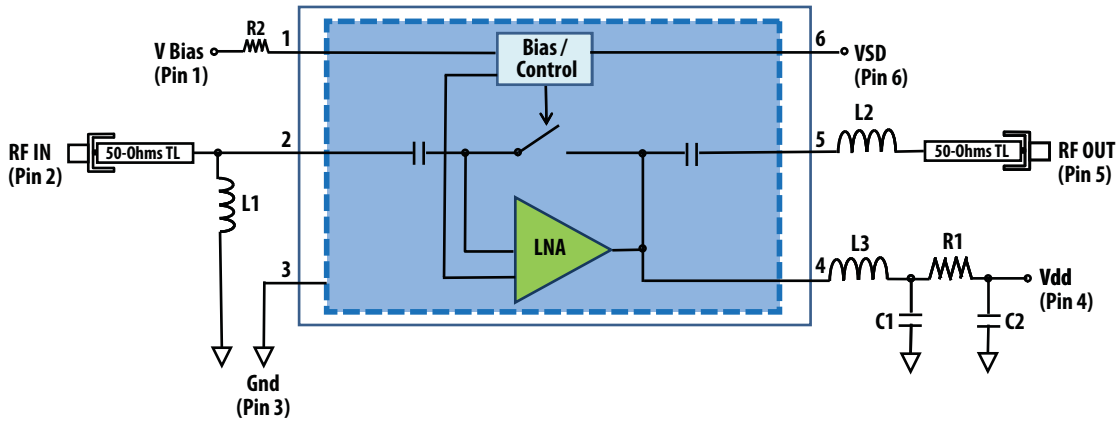

Figure 6. Demo Board Schematic Diagram

Table 2 Typical Components Used For Demo Board In Fig 4 And Schematic Shown In Fig 6. R2 is adjusted for desired current.

Component	Vendor	Size	Value
L1	Taiyo Yuden	0402	2.7 nH
L2	Taiyo Yuden	0402	5.1 nH
L3	Taiyo Yuden	0402	2.4 nH
C1	Taiyo Yuden	0402	10 pF
C2	Murata	0402	0.1 μ F
R1	ROHM	0402	10 ohm
R2	ROHM	0402	2.7 Kohm

MGA-64606 Typical Performance (2.4 GHz match)

$T_A = +25^\circ\text{C}$, $V_{dd} = 3\text{V}$, $I_{ds} = 7\text{mA}$ ($V_{bias} = 1.8\text{V}$), RF measurement at 2.4 GHz, Input Signal = CW unless stated otherwise.

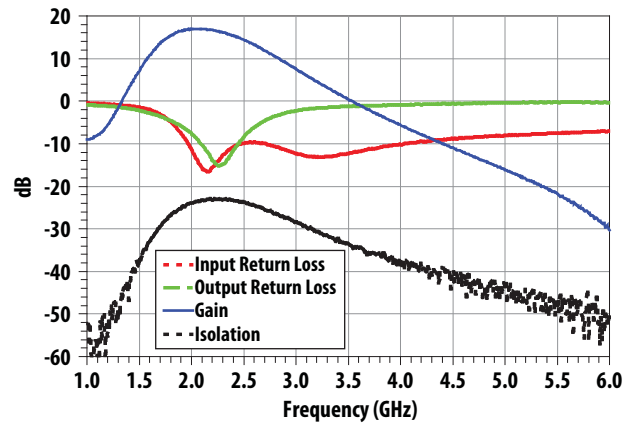

Figure 7. LNA Mode Gain, Input Return Loss, Output Return Loss, Isolation vs Frequency

LNA Mode Plots (2.4 GHz match); $V_{dd} = 3\text{ V}$, $V_{bias} = 1.8\text{ V}$, $V_{sd} = 0\text{ V}$

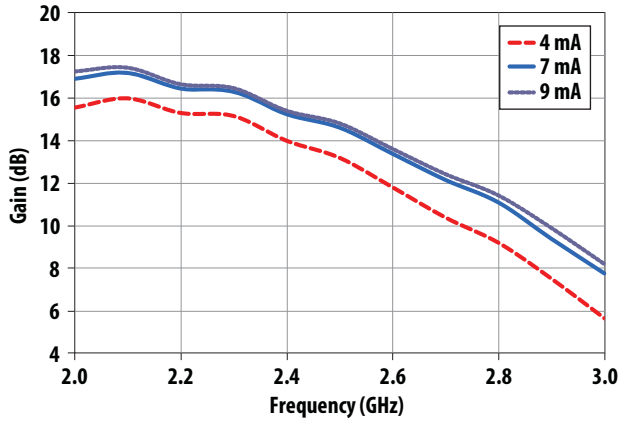

Figure 8. LNA Mode Gain vs Frequency vs Id

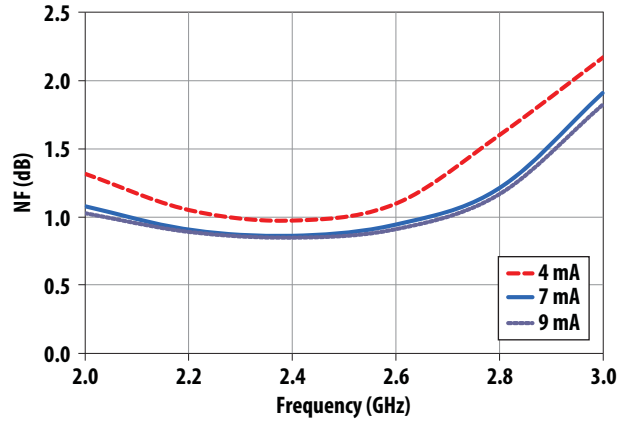

Figure 9. LNA Mode Noise Figure vs Frequency vs Id

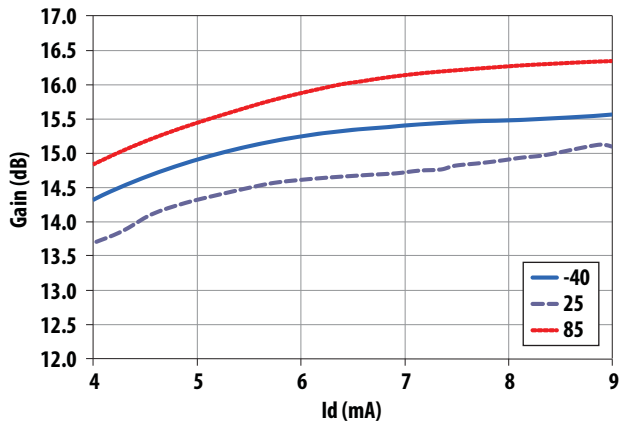

Figure 10. LNA Mode Gain vs Id vs Temperature

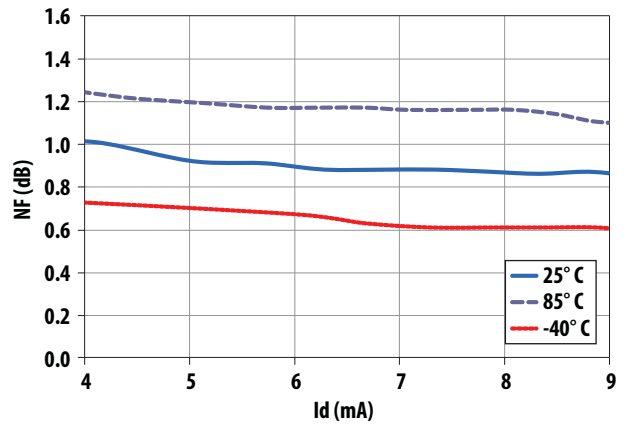

Figure 11. LNA Noise Figure vs Id vs Temperature

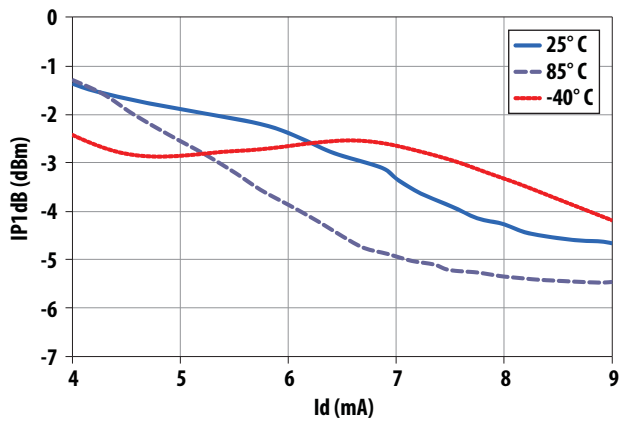

Figure 12. LNA Mode IP1dB vs Id vs Temperature

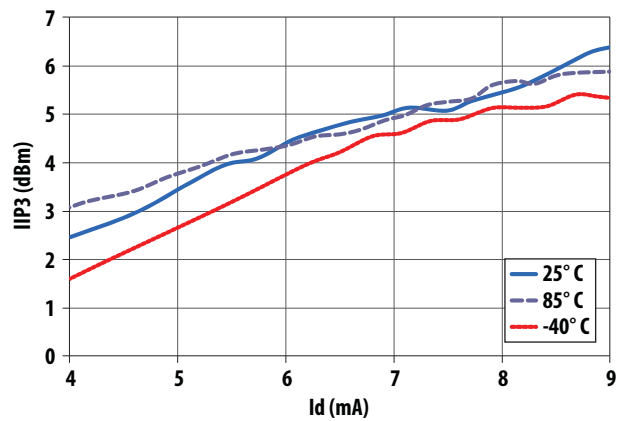

Figure 13. LNA Mode IIP3 vs Id vs Temperature

LNA Mode Plots (2.4 GHz match); Vdd = 3 V, Vbias = 1.8 V, Vsd = 0 V

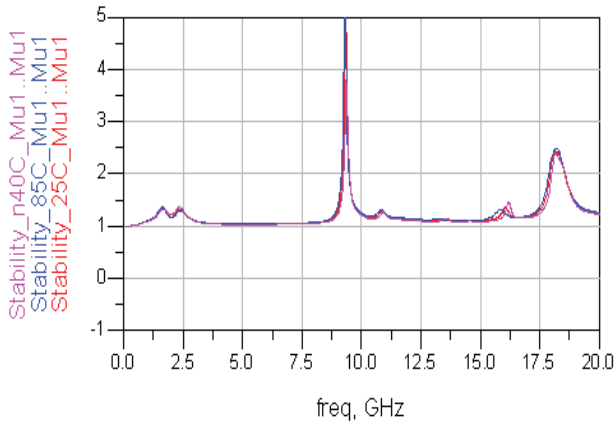

Figure 14. Edwards-Sinsky Output Stability Factor(μ) at Vdd = 3 V

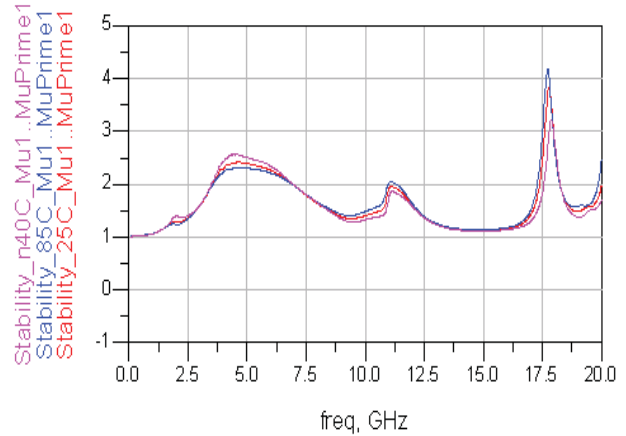

Figure 15. Edwards-Sinsky Input Stability Factor(μ') at Vdd = 3 V

Bypass Mode Plots (2.4 GHz match); Vdd = 3 V, Vbias = 0 V, Vsd = 0 V

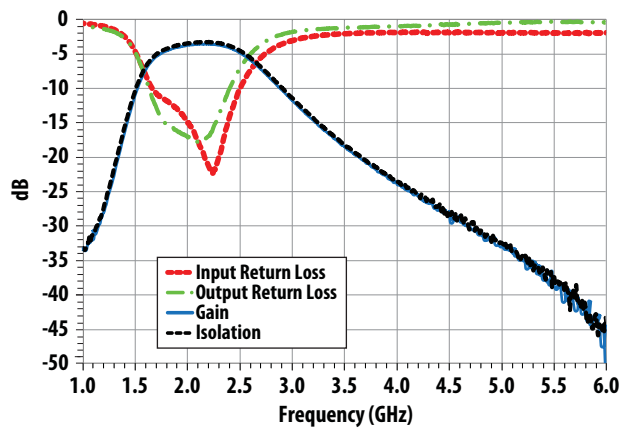

Figure 16. Bypass Mode Gain, Input Return Loss, Output Return Loss, Isolation vs Frequency

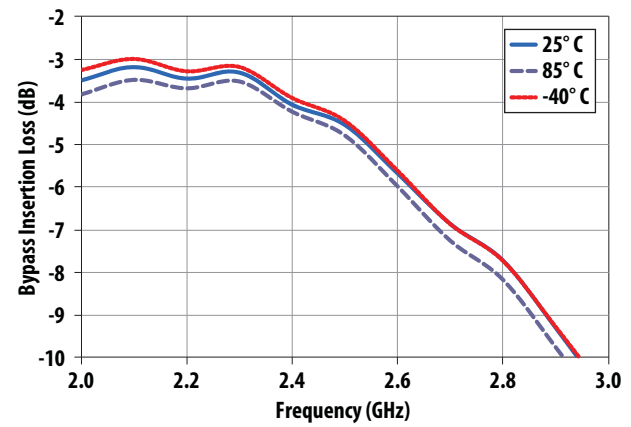

Figure 17. Bypass Mode Insertion Loss vs Frequency vs Temperature

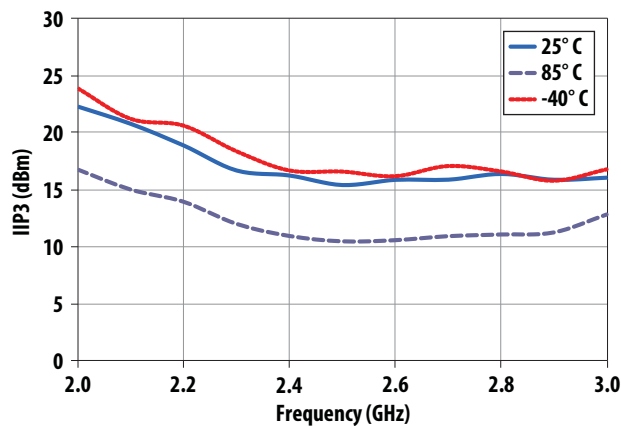

Figure 18. Bypass Mode IIP3 vs Frequency vs Temperature

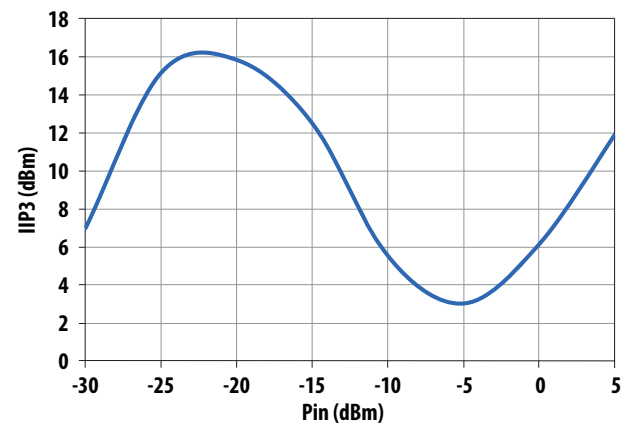

Figure 19. Bypass Mode IIP3 vs Input Power

Shutdown Mode Plots (2.4 GHz match); $V_{dd} = 3\text{ V}$, $V_{bias} = 0\text{ V}$, $V_{sd} = 3\text{ V}$

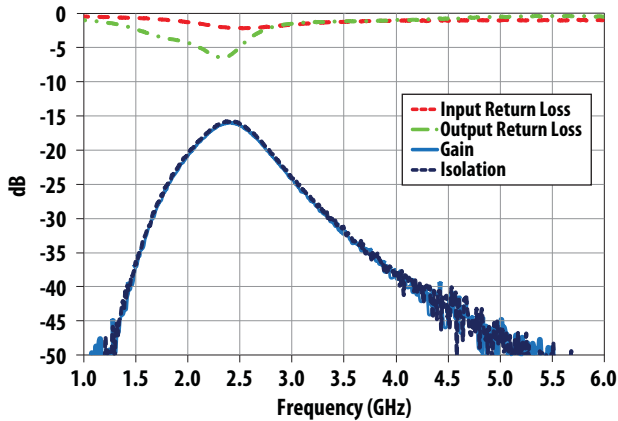

Figure 20. Shutdown Mode Gain, Input Return Loss, Output Return Loss, Isolation vs Frequency

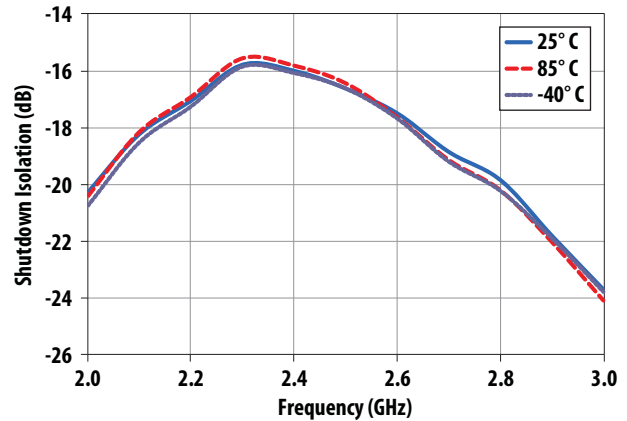

Figure 21. Shutdown Mode Isolation vs Frequency vs Temperature

Demo Board Schematic for 2.5 – 2.7 GHz Application

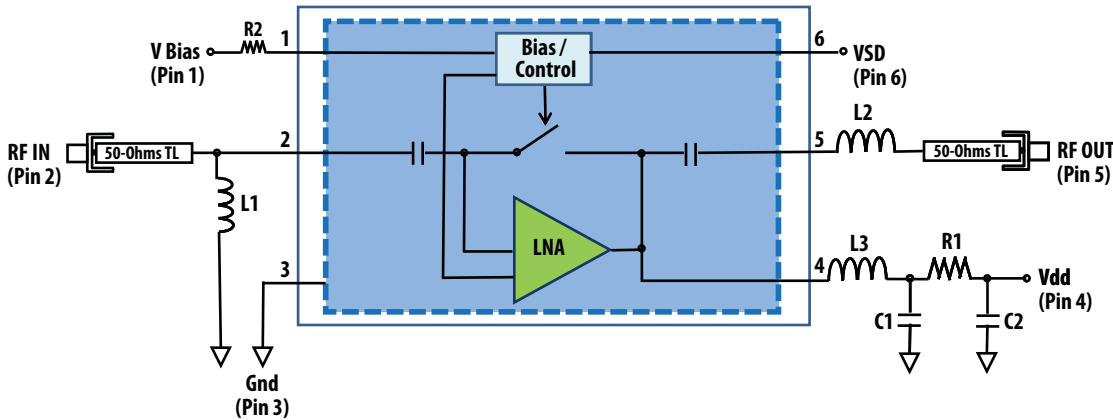

Figure 22. Demo Board Schematic Diagram

Table 3 Typical Components Used For Demo Board In Fig 4 And Schematic Shown In Fig 22.

Component	Vendor	Size	Value
L1	Taiyo Yuden	0402	1.8 nH
L2	Taiyo Yuden	0402	3.9 nH
L3	Taiyo Yuden	0402	1.5 nH
C1	Taiyo Yuden	0402	10 pF
C2	Murata	0402	0.1 μF
R1	ROHM	0402	10 ohm
R2	ROHM	0402	2.7 Kohm

MGA-64606 Typical Performance (2.6 GHz match)

$T_A = +25^\circ\text{ C}$, $V_{dd} = 3\text{ V}$, $I_{ds} = 7\text{ mA}$ ($V_{bias} = 1.8\text{ V}$), RF measurement at 2.6 GHz, Input Signal=CW unless stated otherwise.

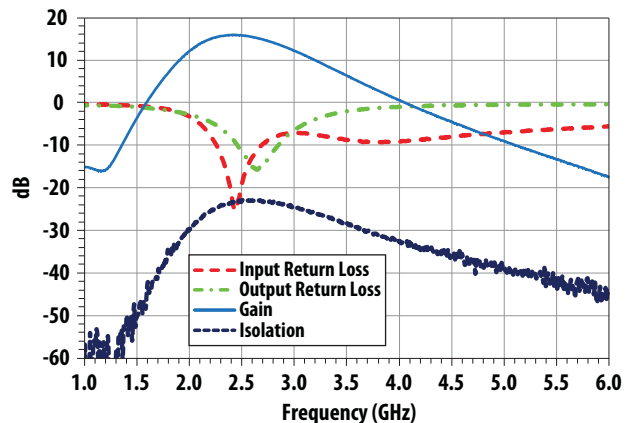

Figure 23. LNA Mode Gain, Input Return Loss, Output Return Loss, Isolation vs Frequency

LNA Mode Plots (2.6 GHz match); $V_{dd} = 3\text{ V}$, $V_{bias} = 1.8\text{ V}$, $V_{sd} = 0\text{ V}$

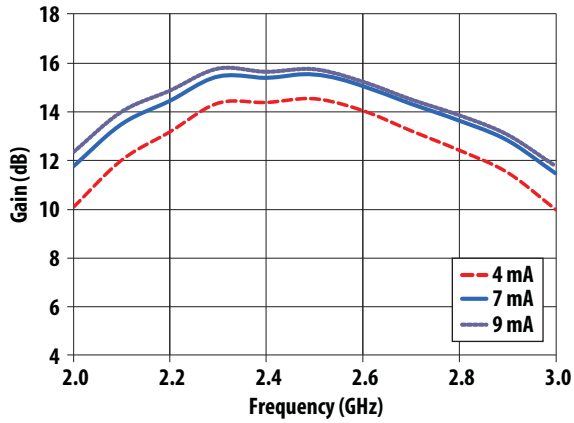

Figure 24. LNA Mode Gain vs Frequency vs I_d

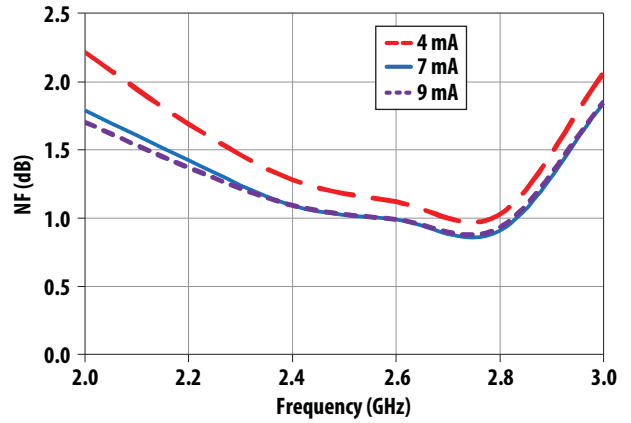

Figure 25. LNA Mode Noise Figure vs Frequency vs I_d

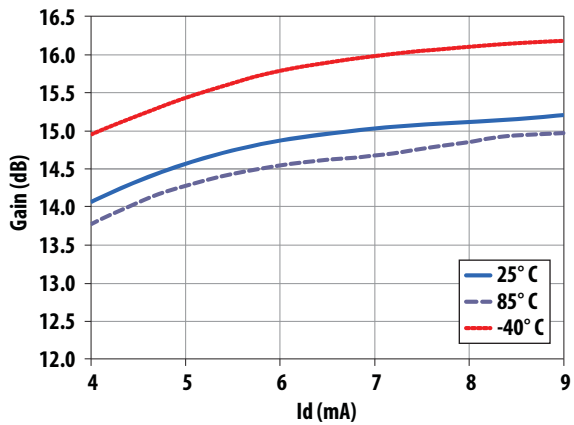

Figure 26. LNA Mode Gain vs I_d vs Temperature

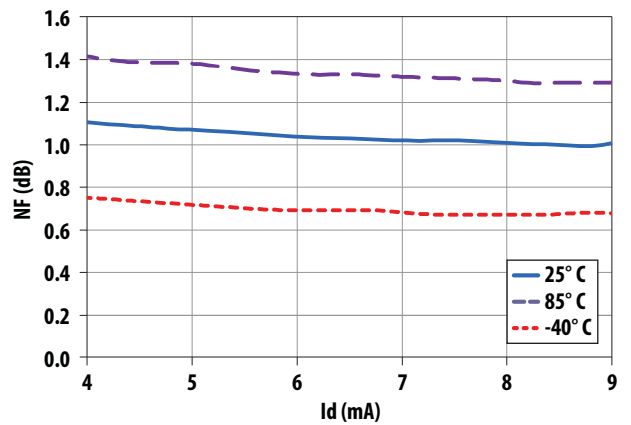

Figure 27. LNA Mode Noise Figure vs I_d vs Temperature

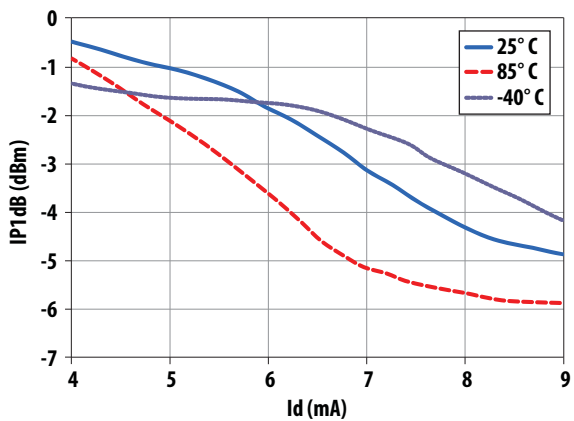

Figure 28. LNA Mode $IP1_{dB}$ vs I_d vs Temperature

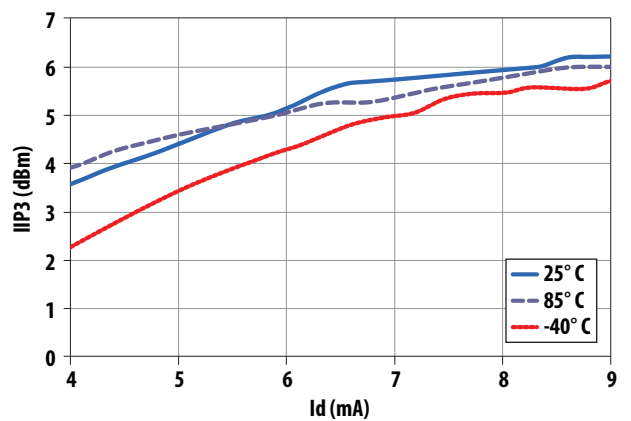

Figure 29. LNA Mode $IIP3$ vs I_d vs Temperature

LNA Mode Plots (2.6 GHz match); Vdd = 3 V, Vbias = 1.8 V, Vsd = 0 V

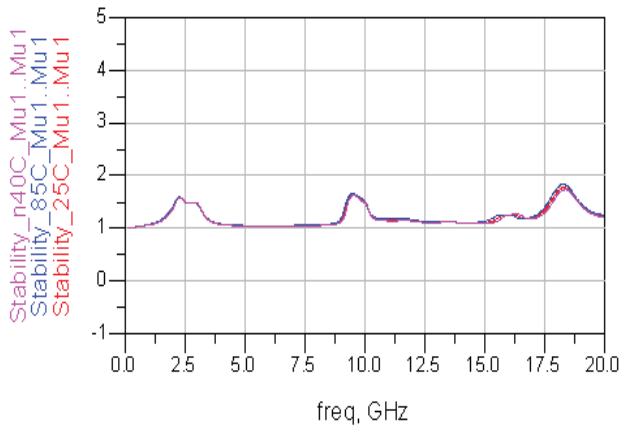

Figure 30. Edwards-Sinsky Output Stability Factor (μ) at Vdd = 3 V

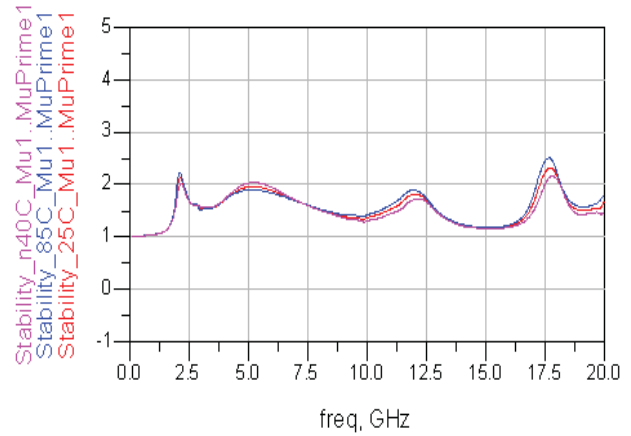

Figure 31. Edwards-Sinsky Input Stability Factor (μ') at Vdd = 3 V

Bypass Mode Plots (2.6 GHz match); Vdd = 3 V, Vbias = 0 V, Vsd = 0 V

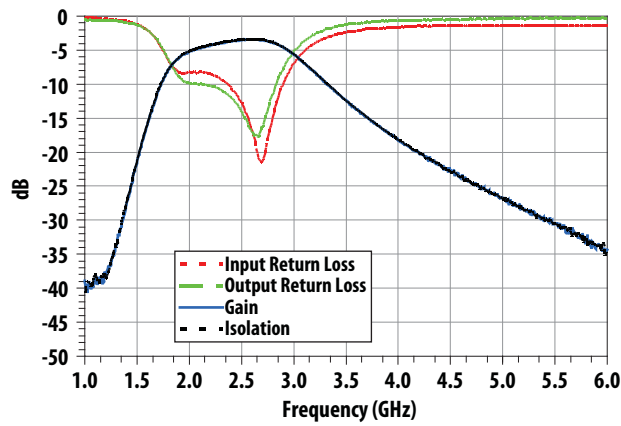

Figure 32. Bypass Mode Gain, Input Return Loss, Output Return Loss, Isolation vs Frequency

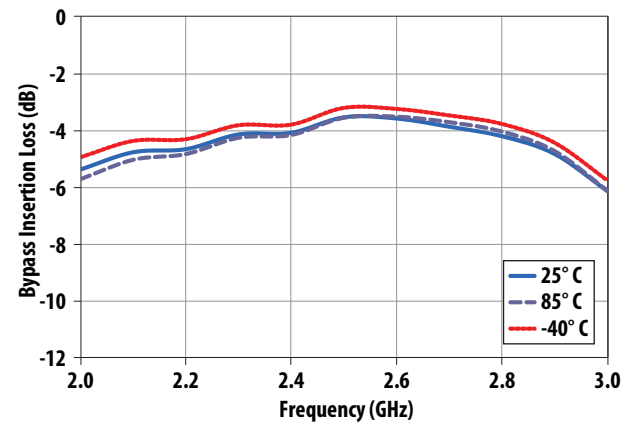

Figure 33. Bypass Mode Insertion Loss vs Frequency vs Temperature

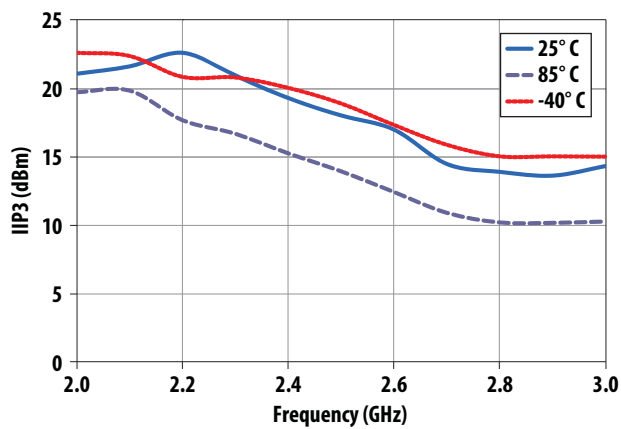

Figure 34. Bypass Mode IIP3 vs Frequency vs Temperature

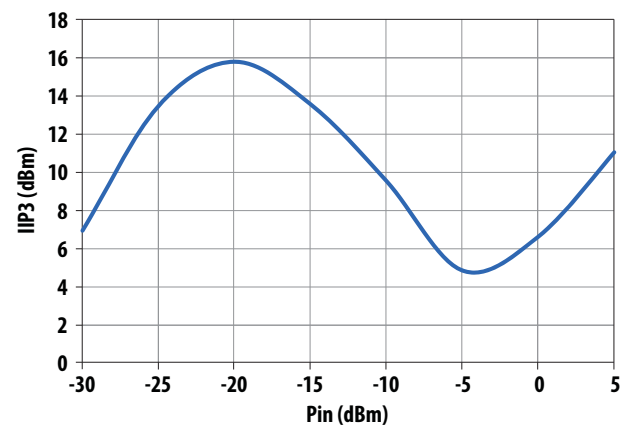

Figure 35. Bypass Mode IIP3 vs Input Power

Shutdown Mode Plots (2.6 GHz match); Vdd = 3 V, Vbias = 0 V, Vsd = 3 V

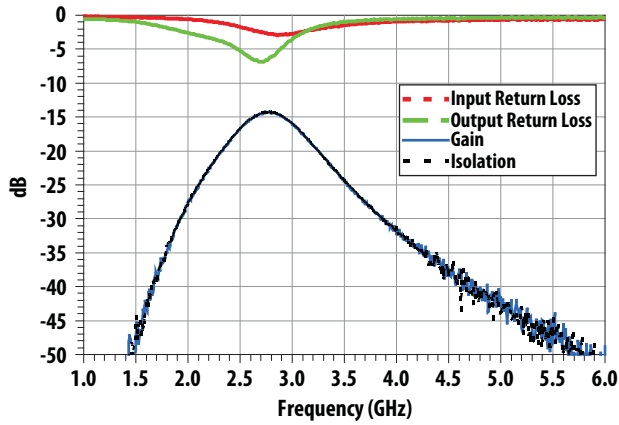

Figure 36. Shutdown Mode Gain, Input Return Loss, Output Return Loss, Isolation vs Frequency

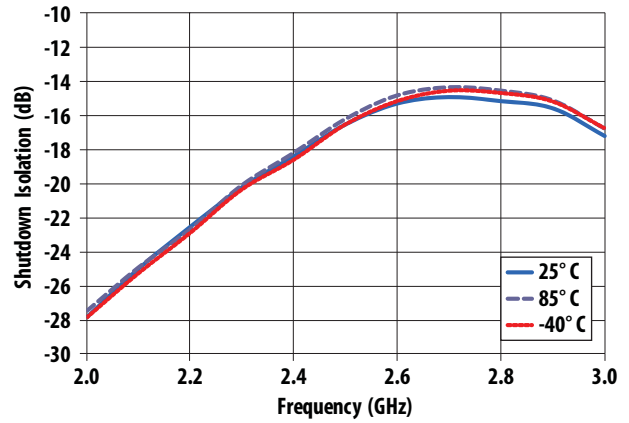
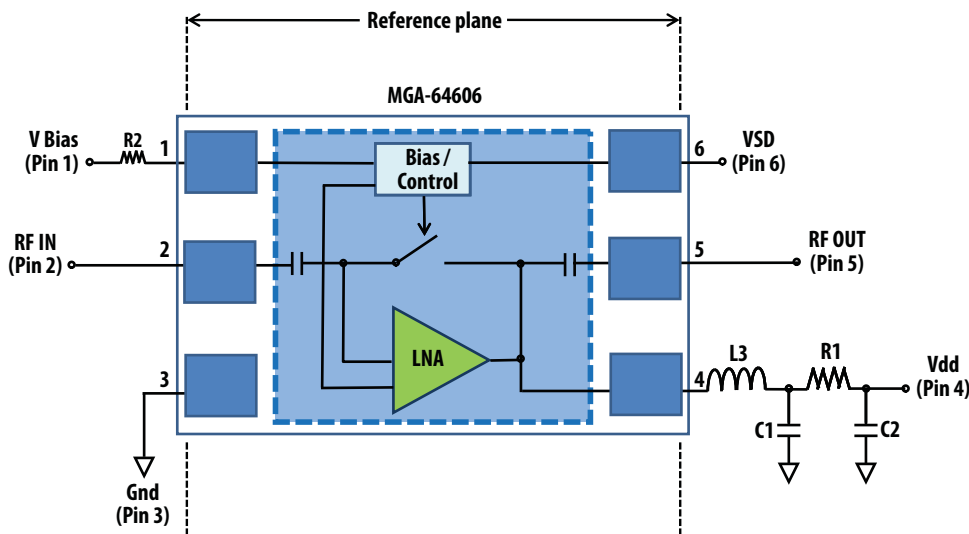

Figure 37. Shutdown Mode Isolation vs Frequency vs Temperature

Test Circuit For S- and Noise parameter measurement [1] (2.4 GHz match)



Note:

1. The measurement is calibrated up to the input (RFIn) and output (RFout) pin of the package.

Component	Vendor	Size	Value
L3	Taiyo Yuden	0402	2.4 nH
C1	Taiyo Yuden	0402	10 pF
C2	Murata	0402	0.1 μ F
R1	ROHM	0402	10 ohm

Figure 38. S-parameter and Noise parameter test circuit on demo board

MGA-64606 LNA Mode typical scattering parameters at 25° C, Vdd = 3 V; Vbias = 1.8 V; Vsd = 0 V

Frequency (GHz)	S11		S21			S12			S22	
	Mag	Angle	dB	Mag	Angle	dB	Mag	Angle	Mag	Angle
0.5	0.952	-21.7	-7.50	0.422	-89.5	-65.71	0.001	154.1	0.980	-17.9
1.0	0.862	-41.7	-1.32	0.859	-129.2	-50.53	0.003	155.7	0.932	-34.9
1.5	0.839	-58.9	5.89	1.969	-118.1	-39.13	0.011	-165.4	0.874	-57.8
2.0	0.577	-92.4	15.00	5.622	155.0	-26.19	0.049	120.9	0.227	-7.1
2.1	0.493	-90.1	14.21	5.134	136.2	-26.33	0.048	104.1	0.442	-5.0
2.2	0.457	-86.4	13.18	4.561	121.9	-26.79	0.046	92.2	0.587	-13.1
2.3	0.445	-83.9	12.16	4.057	110.9	-27.28	0.043	83.3	0.674	-20.8
2.4	0.442	-83.0	11.24	3.649	102.0	-27.64	0.041	76.5	0.730	-27.5
2.5	0.441	-83.1	10.43	3.322	94.4	-27.92	0.040	71.2	0.765	-33.4
2.6	0.439	-84.1	9.72	3.061	87.8	-28.14	0.039	66.3	0.790	-38.7
2.7	0.437	-85.5	9.08	2.846	81.8	-28.28	0.039	62.0	0.806	-43.7
2.8	0.434	-87.3	8.52	2.665	76.2	-28.46	0.038	59.0	0.818	-48.4
2.9	0.432	-89.3	8.00	2.513	70.9	-28.52	0.038	55.7	0.827	-53.0
3.0	0.428	-91.4	7.53	2.380	65.8	-28.58	0.037	52.2	0.834	-57.5
3.5	0.409	-103.2	5.57	1.899	42.8	-28.57	0.037	38.8	0.853	-78.8
4.0	0.394	-114.7	3.93	1.571	22.5	-28.51	0.038	27.4	0.869	-98.0
4.5	0.382	-124.4	2.48	1.330	5.0	-28.56	0.037	18.2	0.885	-113.3
5.0	0.366	-131.9	1.33	1.166	-10.1	-28.36	0.038	12.2	0.899	-124.2
5.5	0.371	-146.7	-0.21	0.976	-26.1	-28.68	0.037	5.0	0.907	-138.9
6.0	0.400	-155.4	-1.30	0.861	-40.9	-28.69	0.037	-0.9	0.909	-149.3
6.5	0.421	-162.0	-2.31	0.767	-55.0	-28.55	0.037	-5.1	0.908	-160.4
7.0	0.434	-167.0	-3.26	0.687	-68.5	-28.41	0.038	-8.8	0.905	-172.8
7.5	0.441	-171.7	-4.21	0.616	-82.0	-28.22	0.039	-11.6	0.904	173.4
8.0	0.447	-177.6	-5.23	0.548	-95.4	-27.96	0.040	-14.3	0.904	159.2
8.5	0.464	174.8	-6.31	0.483	-109.0	-27.69	0.041	-16.8	0.910	145.7
9.0	0.500	164.9	-7.49	0.422	-123.7	-27.34	0.043	-20.5	0.914	134.1
9.5	0.583	151.6	-8.85	0.361	-144.3	-26.84	0.045	-28.9	0.914	125.0
10.0	0.502	137.6	-13.09	0.221	-139.8	-28.92	0.036	-23.9	0.918	119.5

MGA-64606 Bypass Mode typical scattering parameters at 25° C, Vdd = 3 V; Vbias = 0 V; Vsd = 0 V

Frequency (GHz)	S11		S21			S12			S22	
	Mag	Angle	dB	Mag	Angle	dB	Mag	Angle	Mag	Angle
0.5	0.947	-27.9	-39.24	0.011	179.4	-39.07	0.011	178.3	0.979	-18.0
1.0	0.867	-54.3	-26.23	0.049	143.6	-26.22	0.049	143.7	0.928	-34.7
1.5	0.718	-82.1	-13.73	0.206	153.2	-13.74	0.206	153.2	0.809	-58.9
2.0	0.707	-72.5	-7.15	0.439	50.3	-7.14	0.439	50.3	0.671	-26.6
2.1	0.744	-78.4	-7.90	0.403	39.5	-7.89	0.403	39.5	0.742	-31.9
2.2	0.762	-84.0	-8.50	0.376	31.2	-8.50	0.376	31.2	0.784	-37.0
2.3	0.771	-89.2	-8.97	0.356	24.3	-8.97	0.356	24.3	0.809	-41.6
2.4	0.774	-94.0	-9.36	0.341	18.3	-9.35	0.341	18.3	0.826	-45.9
2.5	0.775	-98.7	-9.67	0.329	12.8	-9.65	0.329	12.8	0.836	-50.0
2.6	0.774	-103.2	-9.92	0.319	7.7	-9.92	0.319	7.8	0.843	-54.0
2.7	0.772	-107.5	-10.12	0.312	3.0	-10.12	0.312	3.0	0.847	-58.0
2.8	0.770	-111.7	-10.30	0.305	-1.7	-10.30	0.305	-1.6	0.850	-61.9
2.9	0.769	-115.8	-10.47	0.300	-6.1	-10.46	0.300	-6.2	0.852	-65.9
3.0	0.767	-119.7	-10.62	0.294	-10.6	-10.62	0.294	-10.6	0.853	-69.9
3.5	0.760	-138.4	-11.35	0.271	-31.1	-11.35	0.271	-31.1	0.859	-89.7
4.0	0.758	-154.8	-12.17	0.246	-49.6	-12.17	0.246	-49.7	0.868	-107.8
4.5	0.755	-169.6	-13.02	0.223	-65.9	-13.02	0.223	-65.9	0.879	-122.2
5.0	0.742	176.3	-13.75	0.205	-80.4	-13.74	0.206	-80.4	0.885	-132.6
5.5	0.761	163.9	-15.38	0.170	-95.1	-15.38	0.170	-95.1	0.893	-146.4
6.0	0.764	154.0	-16.56	0.149	-108.6	-16.56	0.149	-108.7	0.889	-156.7
6.5	0.765	145.4	-17.91	0.127	-122.6	-17.89	0.127	-122.7	0.883	-167.7
7.0	0.771	137.9	-19.57	0.105	-138.2	-19.55	0.105	-138.3	0.873	-179.9
7.5	0.791	130.5	-21.98	0.080	-157.6	-21.95	0.080	-157.8	0.866	166.7
8.0	0.833	122.5	-25.85	0.051	175.3	-25.80	0.051	175.3	0.860	153.2
8.5	0.890	112.6	-31.72	0.026	123.9	-31.66	0.026	124.0	0.859	140.7
9.0	0.923	100.5	-32.81	0.023	37.2	-32.83	0.023	37.5	0.855	130.4
9.5	0.909	88.6	-32.29	0.024	3.4	-32.32	0.024	3.3	0.853	124.4
10.0	0.868	78.3	-26.80	0.046	8.9	-26.83	0.046	8.8	0.912	118.6

MGA-64606 LNA Mode typical noise parameters at 25° C, Vdd = 3 V; Vbias = 1.8 V; Vsd = 0 V

Freq. (GHz)	Fmin (dB)	Γ_{opt} Mag	Γ_{opt} Ang	Rn/50
2.0	0.90	0.37	70.40	0.04
2.1	0.78	0.37	71.50	0.05
2.2	0.72	0.38	72.60	0.07
2.3	0.71	0.38	73.70	0.09
2.4	0.77	0.38	74.75	0.13
2.5	0.89	0.39	75.83	0.18
2.6	1.07	0.39	76.92	0.24
2.7	1.30	0.39	78.00	0.30
2.8	1.59	0.40	79.09	0.38
2.9	1.95	0.40	80.18	0.47
3.0	2.36	0.40	81.26	0.57
3.1	2.83	0.41	82.35	0.68
3.2	3.36	0.41	83.43	0.80
3.3	3.95	0.41	84.52	0.94
3.4	4.60	0.42	85.61	1.08
3.5	5.31	0.42	86.69	1.23
3.6	6.08	0.42	87.78	1.39
3.7	6.90	0.43	88.86	1.56
3.8	7.79	0.43	89.95	1.75
3.9	8.73	0.43	91.04	1.94
4.0	9.73	0.43	92.12	2.15

Test Circuit For S- and Noise parameter measurement [1] (2.6 GHz match)

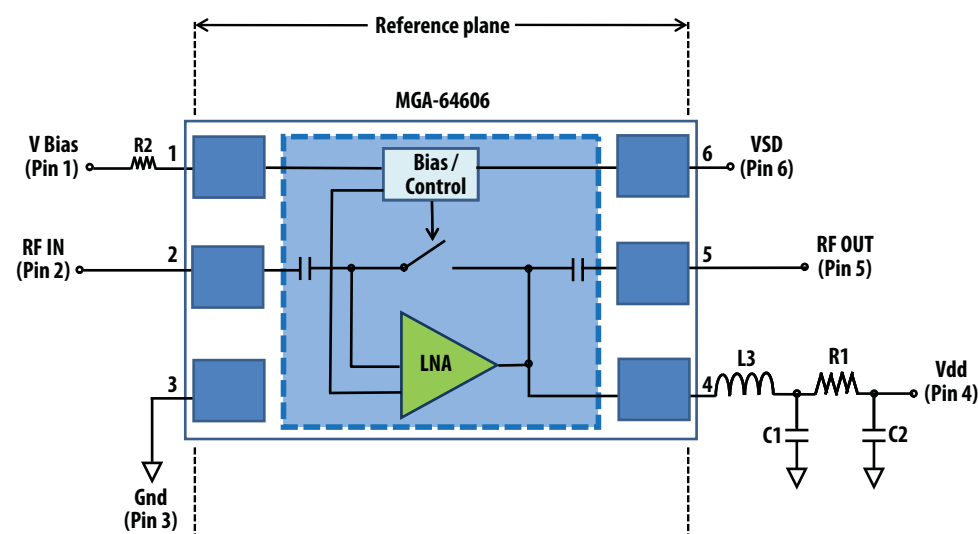

Note:

1. The measurement is calibrated up to the input (RFIn) and output (RFout) pin of the package

Component	Vendor	Size	Value
L3	Taiyo Yuden	0402	1.5 nH
C1	Taiyo Yuden	0402	10 pF
C2	Murata	0402	0.1 μ F
R1	ROHM	0402	10 ohm

Figure 39. S-parameter and Noise parameter test circuit on demo board

MGA-64606 LNA Mode typical scattering parameters at 25° C, Vdd = 3 V; Vbias = 1.8 V; Vsd = 0 V

Frequency (GHz)	S11		S21			S12			S22	
	Mag	Angle	dB	Mag	Angle	dB	Mag	Angle	Mag	Angle
0.5	0.950	-22.6	-8.49	0.376	-95.6	-62.99	0.001	156.3	0.981	-18.2
1.0	0.863	-41.9	-3.11	0.699	-138.9	-53.07	0.002	145.1	0.940	-34.8
1.5	0.824	-55.6	0.81	1.098	-114.4	-44.71	0.006	-162.3	0.925	-53.3
2.0	0.784	-82.2	12.86	4.393	-160.1	-28.41	0.038	166.0	0.552	-102.4
2.1	0.710	-90.5	14.23	5.147	179.4	-26.35	0.048	147.9	0.297	-117.2
2.2	0.602	-96.3	14.67	5.413	157.8	-25.30	0.054	128.4	0.052	-51.8
2.3	0.504	-97.3	14.30	5.190	138.5	-25.08	0.056	111.7	0.267	3.6
2.4	0.444	-94.9	13.52	4.743	122.9	-25.32	0.054	97.9	0.449	-6.4
2.5	0.414	-91.9	12.62	4.274	110.5	-25.73	0.052	87.7	0.568	-16.3
2.6	0.400	-90.2	11.74	3.863	100.3	-26.10	0.050	79.5	0.646	-24.8
2.7	0.394	-89.7	10.93	3.520	91.9	-26.40	0.048	73.3	0.698	-32.1
2.8	0.390	-90.3	10.20	3.236	84.5	-26.69	0.046	67.7	0.734	-38.4
2.9	0.388	-91.7	9.55	3.002	77.8	-26.95	0.045	63.3	0.760	-44.2
3.0	0.385	-93.6	8.95	2.803	71.8	-27.07	0.044	59.2	0.778	-49.6
3.5	0.375	-107.2	6.58	2.133	45.9	-27.49	0.042	42.3	0.827	-72.8
4.0	0.378	-121.0	4.73	1.724	24.3	-27.68	0.041	29.5	0.852	-92.3
4.5	0.388	-131.1	3.18	1.442	5.8	-27.68	0.041	20.0	0.872	-108.1
5.0	0.388	-136.8	1.97	1.255	-10.0	-27.60	0.042	13.1	0.887	-120.3
5.5	0.400	-147.3	0.39	1.046	-26.7	-27.96	0.040	5.0	0.897	-137.3
6.0	0.418	-153.0	-0.77	0.916	-42.1	-28.00	0.040	-1.2	0.904	-149.6
6.5	0.420	-158.5	-1.83	0.810	-56.6	-28.01	0.040	-6.1	0.909	-161.6
7.0	0.411	-165.2	-2.79	0.725	-70.3	-27.83	0.041	-10.1	0.910	-173.4
7.5	0.403	-174.7	-3.70	0.653	-83.9	-27.60	0.042	-12.6	0.910	174.6
8.0	0.413	172.8	-4.66	0.584	-98.0	-27.26	0.043	-15.7	0.906	161.8
8.5	0.454	160.7	-5.77	0.515	-111.9	-27.05	0.044	-18.9	0.908	148.9
9.0	0.516	151.3	-7.03	0.445	-126.3	-26.72	0.046	-22.5	0.908	136.6
9.5	0.580	144.2	-8.39	0.381	-141.1	-26.36	0.048	-25.8	0.913	125.9
10.0	0.638	136.8	-9.77	0.325	-160.2	-25.28	0.054	-37.3	0.885	118.0

MGA-64606 Bypass Mode typical scattering parameters at 25° C, Vdd = 3 V; Vbias = 0 V; Vsd = 0 V

Frequency (GHz)	S11		S21			S12			S22	
	Mag	Angle	dB	Mag	Angle	dB	Mag	Angle	Mag	Angle
0.5	0.949	-28.7	-40.47	0.009	171.4	-40.13	0.010	173.4	0.980	-18.2
1.0	0.884	-54.2	-28.15	0.039	134.3	-28.18	0.039	134.8	0.938	-34.5
1.5	0.805	-78.6	-19.50	0.106	163.1	-19.48	0.106	163.0	0.906	-53.7
2.0	0.474	-73.1	-5.43	0.535	85.9	-5.42	0.536	85.9	0.309	-47.1
2.1	0.581	-70.7	-5.61	0.524	65.1	-5.60	0.525	65.0	0.447	-27.9
2.2	0.660	-75.5	-6.24	0.487	49.6	-6.25	0.487	49.5	0.582	-29.5
2.3	0.704	-81.7	-6.91	0.451	38.0	-6.91	0.451	38.0	0.668	-34.5
2.4	0.729	-87.7	-7.50	0.422	28.9	-7.50	0.422	28.8	0.723	-39.8
2.5	0.741	-93.5	-8.00	0.398	21.3	-7.99	0.398	21.2	0.757	-44.6
2.6	0.746	-99.0	-8.41	0.380	14.6	-8.41	0.380	14.6	0.781	-49.3
2.7	0.749	-104.3	-8.76	0.365	8.6	-8.76	0.365	8.6	0.796	-53.7
2.8	0.749	-109.5	-9.06	0.352	3.0	-9.06	0.352	3.0	0.808	-58.0
2.9	0.749	-114.5	-9.32	0.342	-2.2	-9.33	0.342	-2.3	0.817	-62.1
3.0	0.750	-119.4	-9.57	0.332	-7.2	-9.56	0.333	-7.2	0.823	-66.2
3.5	0.753	-141.4	-10.64	0.294	-29.8	-10.65	0.294	-29.9	0.845	-86.0
4.0	0.763	-159.0	-11.71	0.260	-49.1	-11.71	0.260	-49.1	0.860	-103.9
4.5	0.769	-172.6	-12.69	0.232	-65.3	-12.69	0.232	-65.3	0.871	-118.8
5.0	0.760	175.6	-13.43	0.213	-79.7	-13.43	0.213	-79.7	0.875	-130.6
5.5	0.773	165.1	-15.00	0.178	-94.6	-15.00	0.178	-94.7	0.883	-146.4
6.0	0.768	155.0	-16.14	0.156	-109.0	-16.14	0.156	-109.0	0.882	-158.4
6.5	0.761	144.0	-17.50	0.133	-124.2	-17.50	0.133	-124.2	0.881	-169.8
7.0	0.765	132.1	-19.28	0.109	-141.0	-19.27	0.109	-141.0	0.877	179.0
7.5	0.794	120.4	-21.89	0.080	-161.4	-21.90	0.080	-161.4	0.871	167.4
8.0	0.849	110.1	-26.31	0.048	170.6	-26.22	0.049	170.6	0.860	155.3
8.5	0.912	101.2	-33.08	0.022	116.9	-33.09	0.022	117.2	0.858	143.0
9.0	0.939	93.0	-32.82	0.023	27.3	-32.89	0.023	27.1	0.853	131.6
9.5	0.918	85.3	-29.69	0.033	-6.5	-29.72	0.033	-5.8	0.851	122.0
10.0	0.871	77.4	-29.19	0.035	-18.1	-29.15	0.035	-17.9	0.814	116.4

MGA-64606 LNA Mode typical noise parameters at 25° C, Vdd = 3 V; Vbias = 1.8 V; Vsd = 0 V

Freq. (GHz)	Fmin (dB)	Γ_{opt} Mag	Γ_{opt} Ang	Rn/50
2.0	1.03	0.43	62.70	0.06
2.1	0.84	0.42	63.50	0.07
2.2	0.72	0.42	64.90	0.08
2.3	0.65	0.42	66.20	0.11
2.4	0.65	0.41	67.50	0.14
2.5	0.71	0.41	68.80	0.18
2.6	0.83	0.40	70.13	0.23
2.7	1.01	0.40	71.44	0.28
2.8	1.25	0.40	72.75	0.34
2.9	1.55	0.39	74.06	0.41
3.0	1.91	0.39	75.37	0.49
3.1	2.34	0.39	76.68	0.57
3.2	2.82	0.38	77.99	0.66
3.3	3.37	0.38	79.30	0.76
3.4	3.97	0.37	80.61	0.86
3.5	4.64	0.37	81.92	0.98
3.6	5.37	0.37	83.23	1.10
3.7	6.16	0.36	84.54	1.22
3.8	7.01	0.36	85.85	1.36
3.9	7.92	0.36	87.16	1.50
4.0	8.89	0.35	88.47	1.65

Package Dimensions

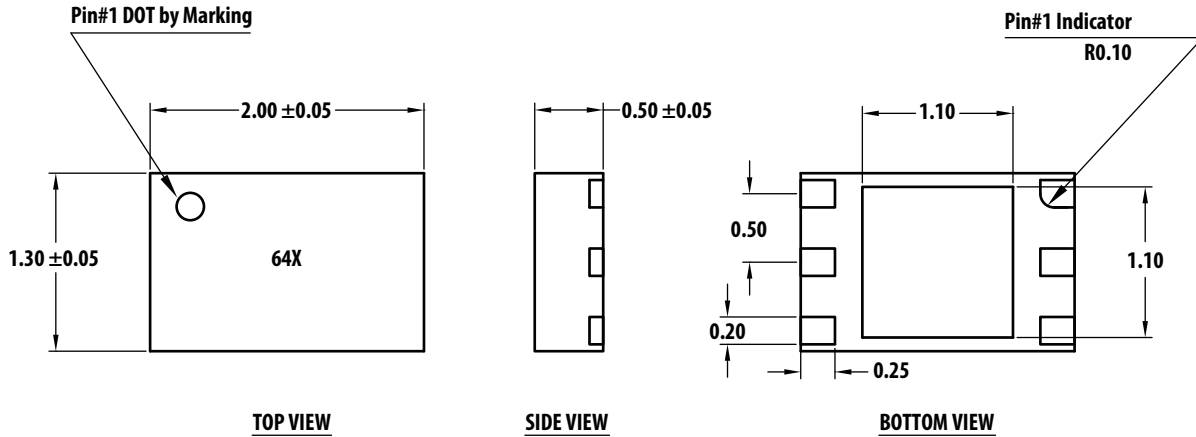

Notes:

1. All dimensions are in millimeters.
2. Dimensions are inclusive of plating.
3. Dimensions are exclusive of mold flash and metal burr.

PCB Land Patterns and Stencil Design

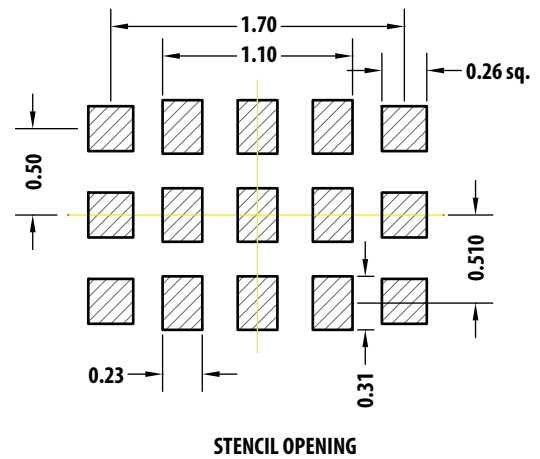
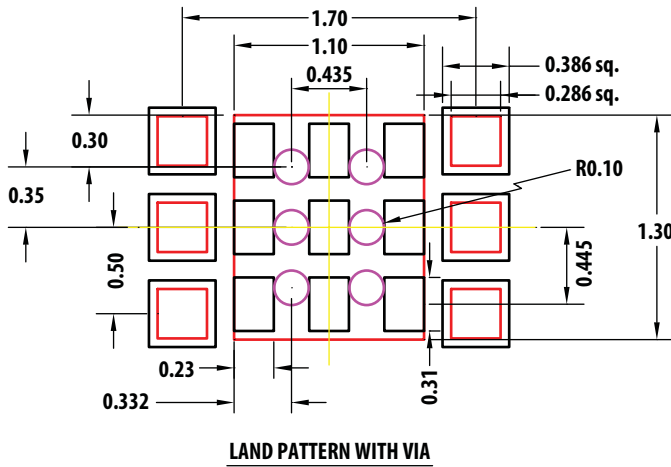

Notes:

1. All dimension are in mm.
2. Recommend to use standard 4 mils Stencil thickness.

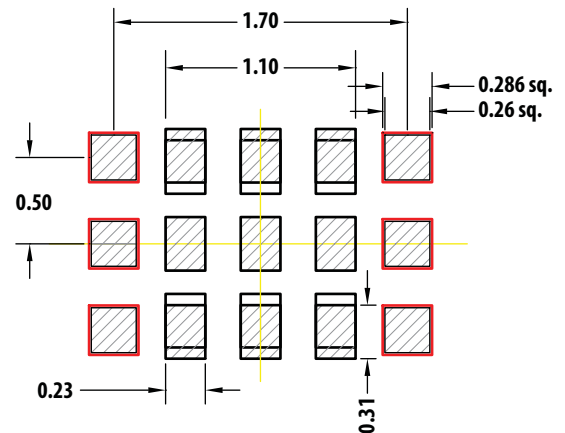

Device Orientation

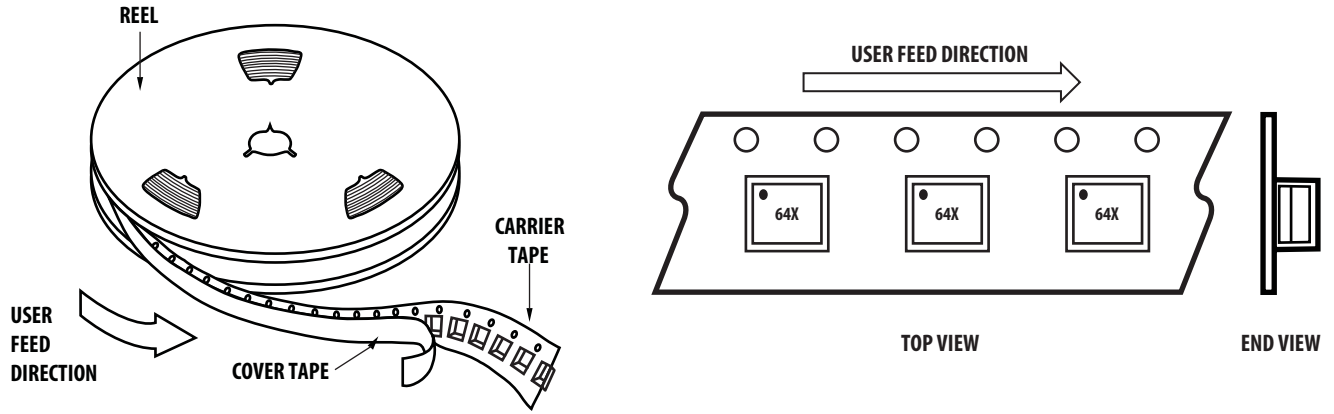

Tape Dimensions (all dimensions in mm)

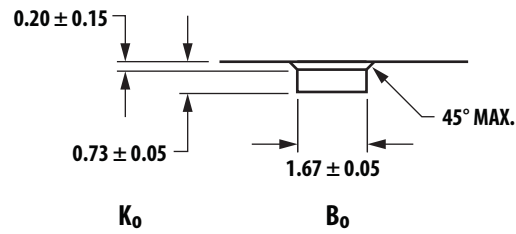
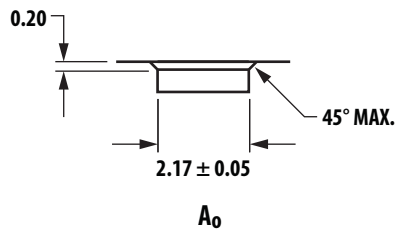
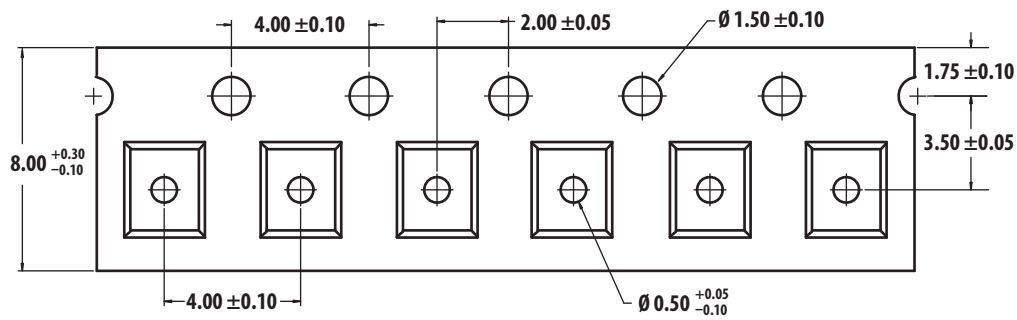

Part Number Ordering Information

Part #	Qty	Container
MGA-64606-BLKG	100	Antistatic Bag
MGA-64606-TR1G	3000	7" Reel
MGA-64606-TR2G	10000	13" Reel

Reel Dimensions

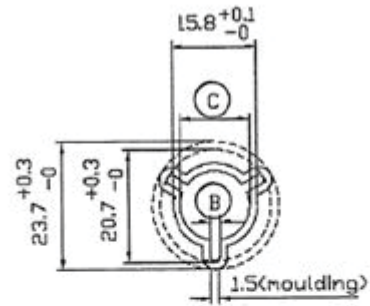
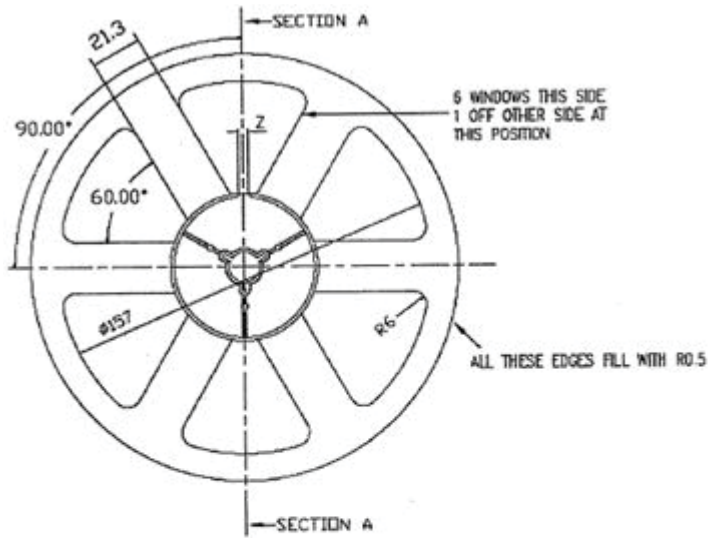

HUB DETAIL

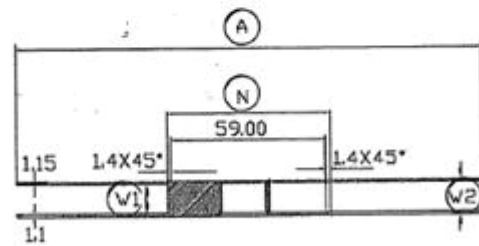

SECTION A

For product information and a complete list of distributors, please go to our web site: www.avagotech.com

Avago, Avago Technologies, and the A logo are trademarks of Avago Technologies in the United States and other countries. Data subject to change. Copyright © 2005-2011 Avago Technologies. All rights reserved. AV02-2888EN - November 15, 2011

AVAGO
TECHNOLOGIES