

## RELAY click™

### 1. Introduction

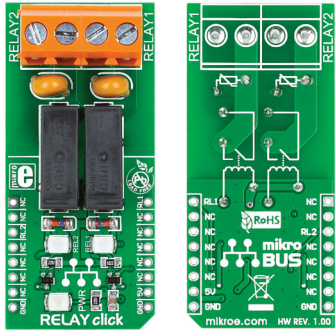

RELAY Click™ is an add-on board in mikroBUS™ form factor. It's a compact and easy solution for adding RELAY to your design. It features two **G6D1AASI-5DC** power PCB relay modules as well as two screw terminals. RELAY Click™ communicates with target board microcontroller via mikroBUS™ PWM (RL1) and CS (RL2) pins. The board is designed to use 5V power supply only. LED diode (Green) indicates the presence of power supply.

### 2. Soldering the headers

Before using your click board™, make sure to solder 1x8 male headers to both left and right side of the board. Two 1x8 male headers are included with the board in the package.

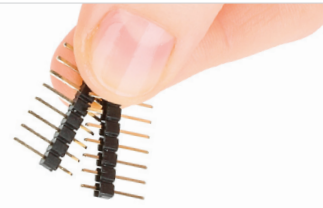

1

2

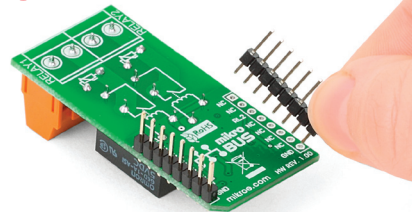

Turn the board upside down so that bottom side is facing you upwards. Place shorter parts of the header pins in both soldering pad locations.

3

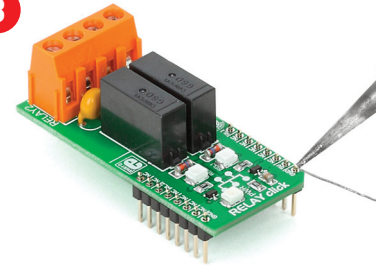

Turn the board upward again. Make sure to align the headers so that they are perpendicular to the board, then solder the pins carefully.

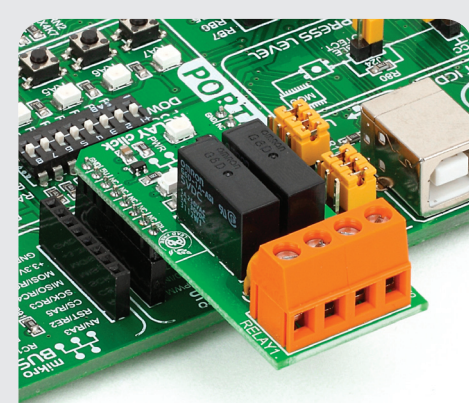

### 4. Essential features

Relay is an electrical switch used to terminate or establish circuit using a low power signal from a microcontroller. Relay provides complete electrical isolation between microcontroller and controlled circuits. Use the RELAY Click™ board with it's two **G6D1AASI-5DC** relays to control various devices with up to 5A, 250V AC/30V DC loads.

### 3. Plugging the board in

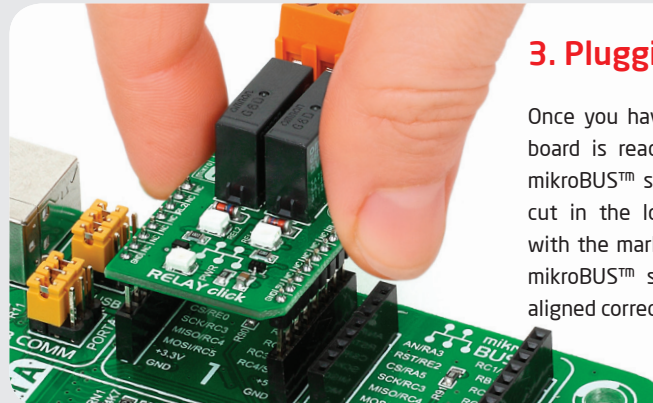

Once you have soldered the headers your board is ready to be placed into desired mikroBUS™ socket. Make sure to align the cut in the lower-right part of the board with the markings on the silkscreen at the mikroBUS™ socket. If all of the pins are aligned correctly, push the board all the way into the socket.

click™  
BOARD  
[www.mikroe.com](http://www.mikroe.com)

Relay click Manual  
ver. 1.00



0 100000 023129

## 5. RELAY Click™ Board Schematic

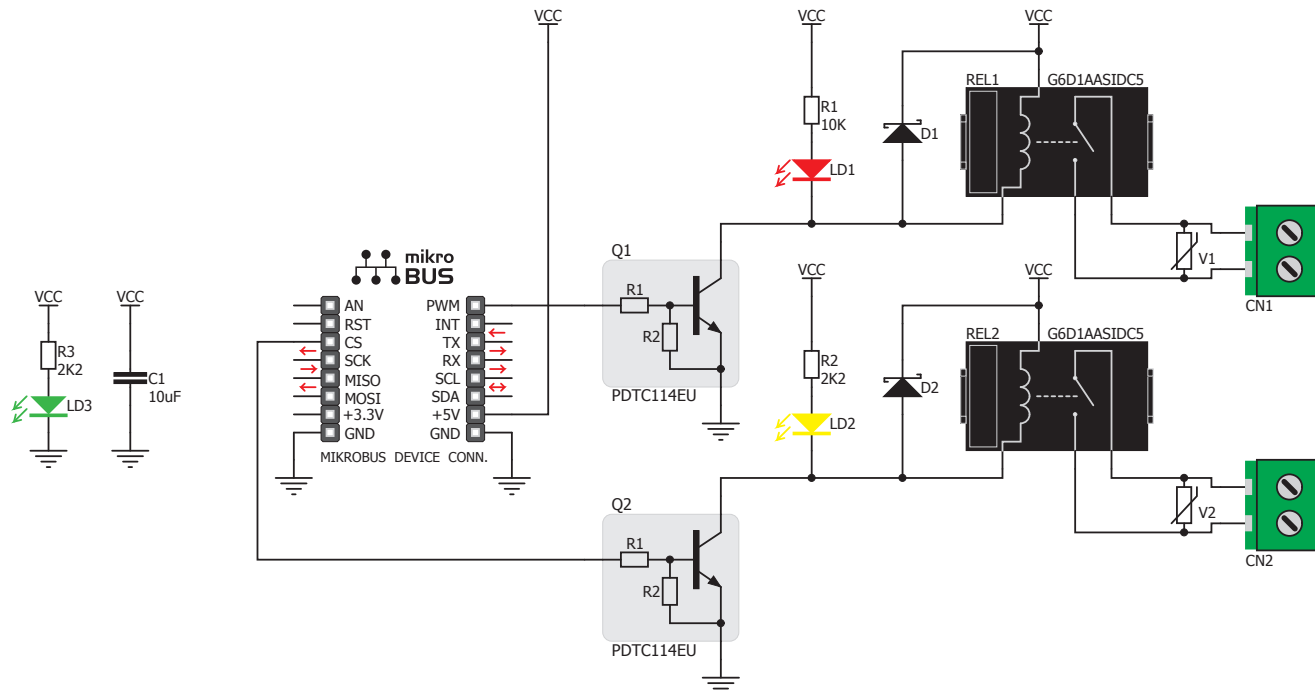

## 6. Communication lines

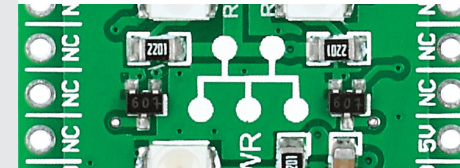

Communication lines voltage level can be in range between 1.8V and 5V. **On-board transistors** are used to drive relays by current sinking.

## 7. Code Examples

Once you have done all the necessary preparations, it's time to get your click board up and running. We have provided the examples for mikroC, mikroBasic and mikroPascal compilers on our **Libstock** website. Just download them and you are ready to start.



## 8. Support

MikroElektronika offers **Free Tech Support** ([www.mikroe.com/esupport](http://www.mikroe.com/esupport)) until the end of product lifetime, so if something goes wrong, we are ready and willing to help!