

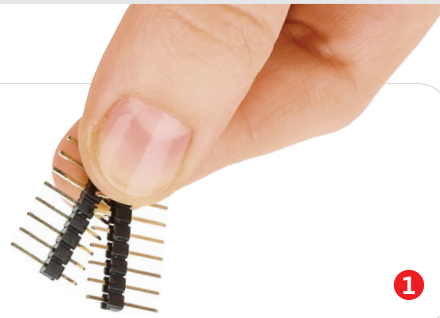

GNSS click™

2. Soldering the headers

Before using your click™ board, make sure to solder 1x8 male headers to both left and right side of the board. Two 1x8 male headers are included with the board in the package.



2

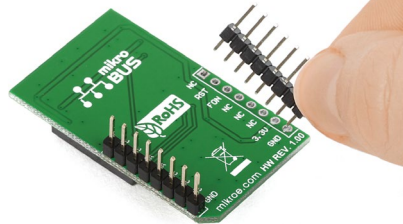

Turn the board upside down so that the bottom side is facing you upwards. Place shorter pins of the header into the appropriate soldering pads.

3

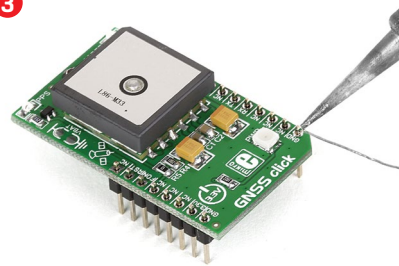

Turn the board upward again. Make sure to align the headers so that they are perpendicular to the board, then solder the pins carefully.

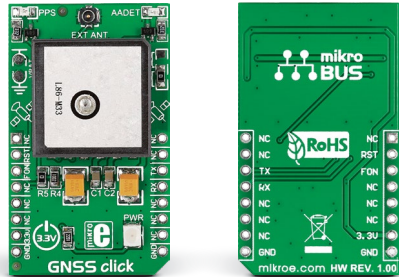

1. Introduction

GNSS click™ carries **Quectel's L86 GNSS module** with a patch antenna along with an external antenna connector. GNSS stands for **global navigation satellite system**, a term which encompasses both the United States **GPS** and the Russian **GLONASS** global positioning systems. The board communicates with the target MCU through **mikroBUS™ UART (TX, RX)**, **CS** (used here for FON), and **RST** pins. The board uses a 3.3V power supply only. A **V_BAT connection** pad for a backup power supply is also available.

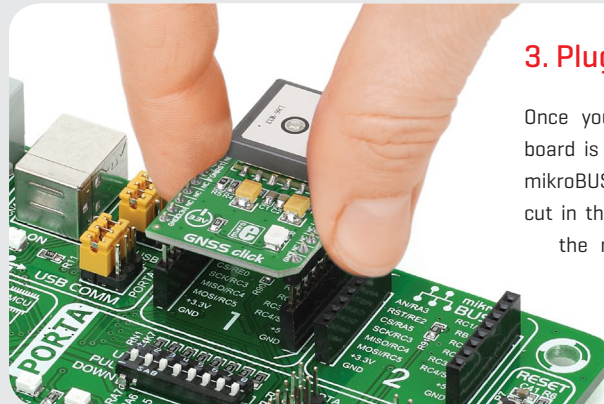

3. Plugging the board in

Once you have soldered the headers your board is ready to be placed into the desired mikroBUS™ socket. Make sure to align the cut in the lower-right part of the board with the markings on the silkscreen at the mikroBUS™ socket. If all the pins are aligned correctly, push the board all the way into the socket.

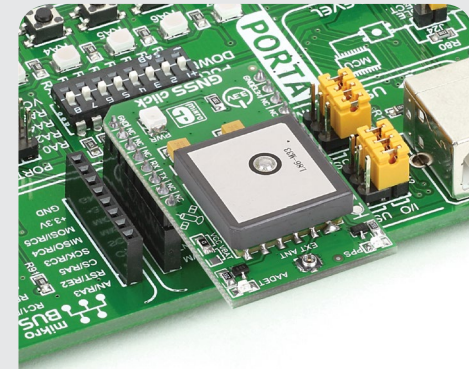

4. Essential features

GNSS click™ shares the same form factor of Quectel's L80 module which (used on GPS3 click™) and the same set of technologies: automatic prediction of orbits from data stored in internal flash (**EASY™** technology); and adaptive adjusting of on/off time to balance between positioning accuracy and power consumption (**AlwaysLocate™** technology). The module can also automatically switch between the internal patch antenna and external active antenna, keeping track of positioning during the switching process.

click™
BOARD
www.mikroe.com



GNSS click™ manual
ver 1.00



5. Schematic

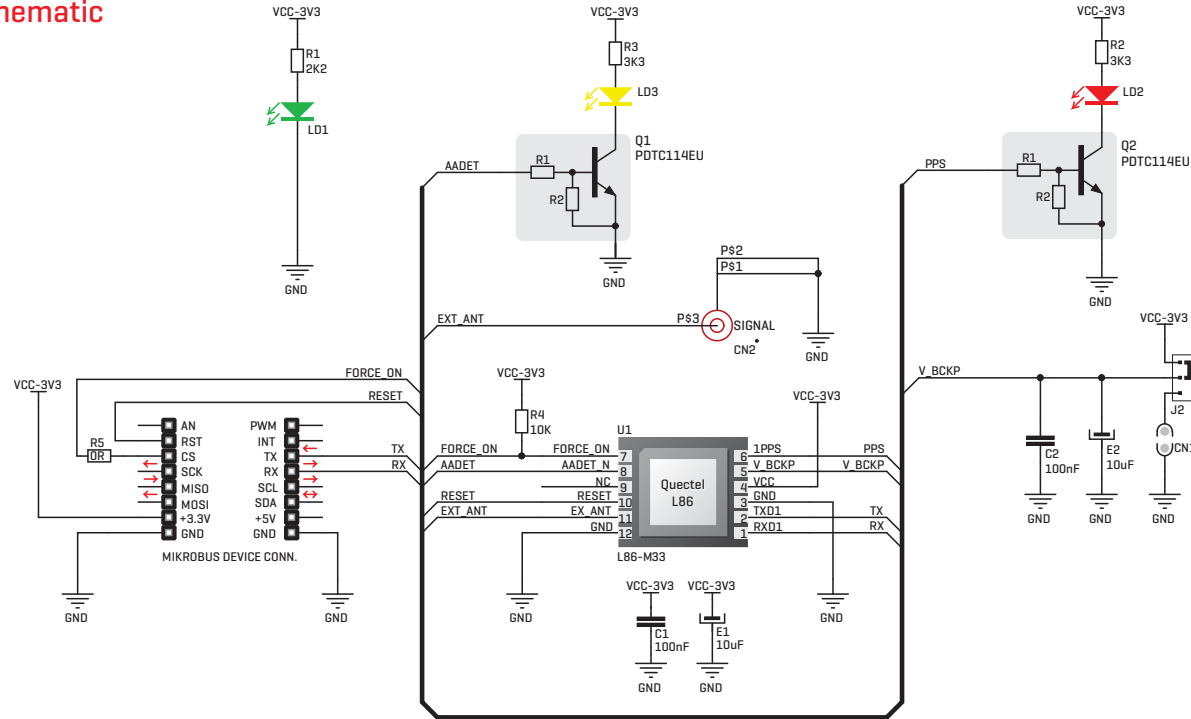

6. Dimensions

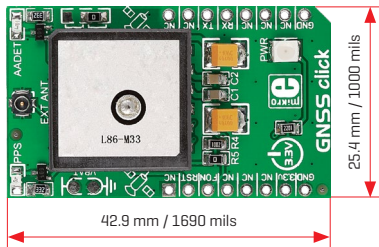

	mm	mils
LENGTH	42.9	1690
WIDTH	25.4	1000
HEIGHT*	8.6	388.6

* without headers

7. External antenna connector



GNSS click™ has a connector for an external active antenna that could be used alongside, or instead of the patch antenna that's already on the module. To get one, search for "GPS antenna" at www.mikroe.com/store

8. Code examples

Once you have done all the necessary preparations, it's time to get your click™ board up and running. We have provided examples for mikroC™, mikroBasic™ and mikroPascal™ compilers on our **Libstock** website. Just download them and you are ready to start.



9. Support

MikroElektronika offers **free tech support** [www.mikroe.com/support] until the end of the product's lifetime, so if something goes wrong, we're ready and willing to help!



10. Disclaimer

MikroElektronika assumes no responsibility or liability for any errors or inaccuracies that may appear in the present document. Specification and information contained in the present schematic are subject to change at any time without notice.

Copyright © 2015 MikroElektronika.
All rights reserved.