

WiFi 4 click

2. Soldering the headers

Before using your click board™, make sure to solder 1x8 male headers to both left and right side of the board. Two 1x8 male headers are included with the board in the package.

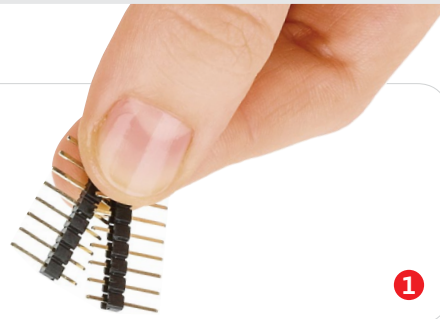

1

2

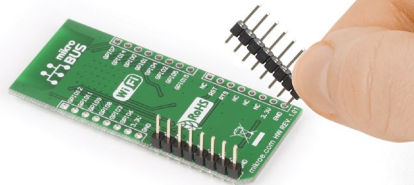

Turn the board upside down so that the bottom side is facing you upwards. Place shorter pins of the header into the appropriate soldering pads.

3

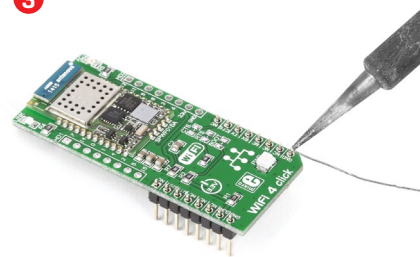

Turn the board upward again. Make sure to align the headers so that they are perpendicular to the board, then solder the pins carefully.

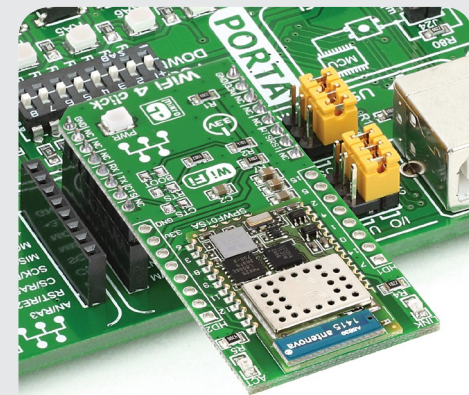

4. Essential features

WiFi 4 click has a full featured TCP/IP protocol stack with added web server and application service capabilities. The additional GPIO pins that line the edges of the board have alternate functions like SPI, ADC, I2C, DAC (although access to those functions depends on the firmware version loaded in the module). The SPWF01SA module has 1.5 MB of internal flash and 64 KB of RAM, and can achieve up to +18 dBm of output power.

1. Introduction

WiFi 4 click carries **SPWF01SA**, a complete standalone WiFi module with a single-chip 802.11 b/g/n transceiver, a 32-bit STM32 MCU, along with a built-in 2.4 GHz ISM band antenna. The board communicates with the target MCU through mikroBUS™ UART pins, with additional functionality provided by Reset and Ready To Send pins (in place of default mikroBUS™ RST and CS pins). The board is also lined with 14 additional GPIO pins. Uses 3.3V power supply.

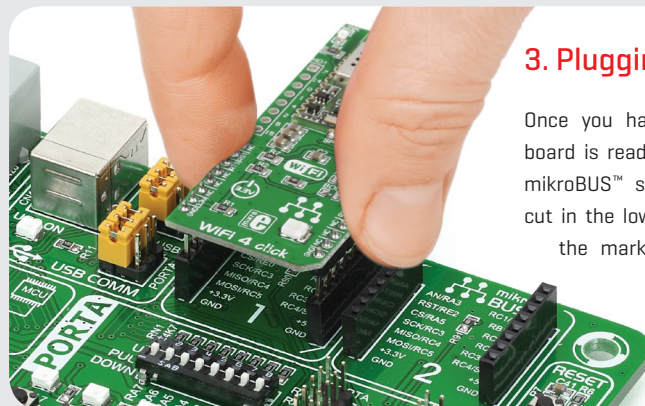

3. Plugging the board in

Once you have soldered the headers your board is ready to be placed into the desired mikroBUS™ socket. Make sure to align the cut in the lower-right part of the board with the markings on the silkscreen at the mikroBUS™ socket. If all the pins are aligned correctly, push the board all the way into the socket.

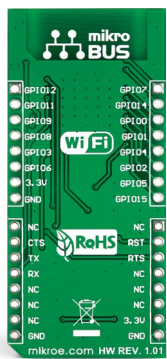

click
BOARD™
www.mikroe.com



WiFi 4 click manual
ver 1.01



010000079805

5. Schematic

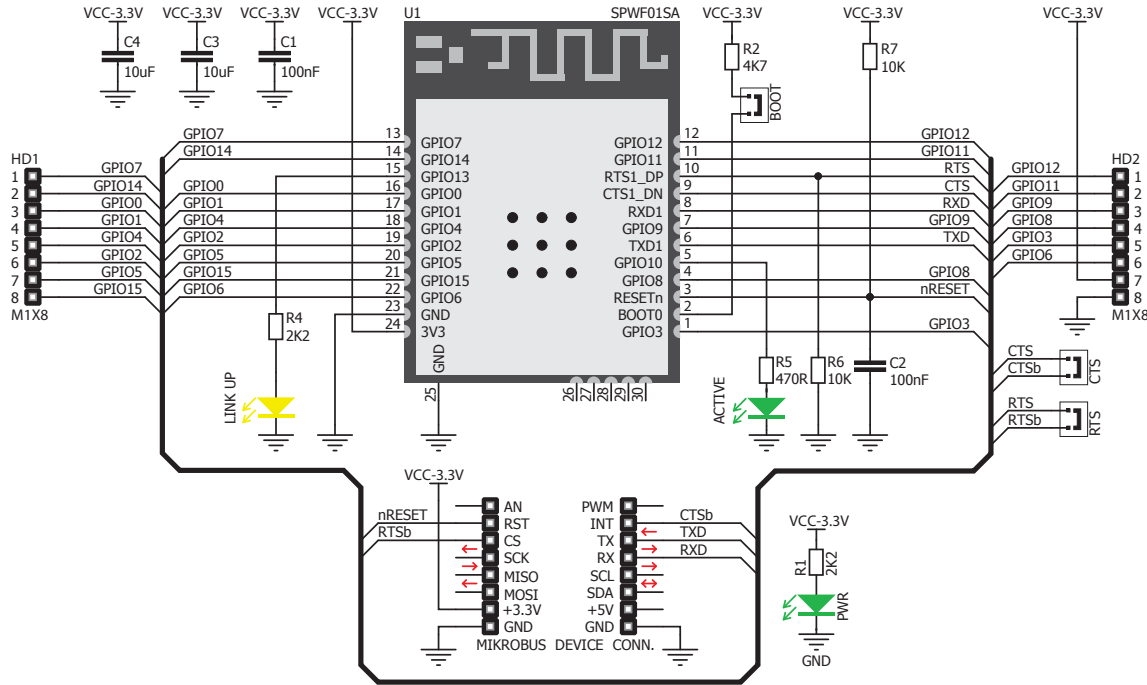

6. Dimensions

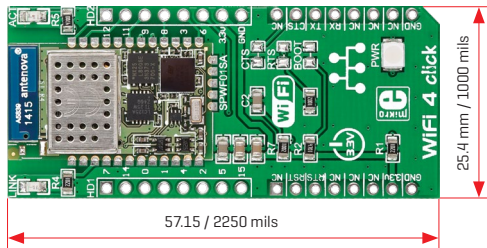

	mm	mils
LENGTH	57.15	2250
WIDTH	25.4	1000
HEIGHT*	3.8	150

* without headers

7. SMD jumpers



To enable access to CTS and RTS pins, solder zero ohm resistors to CTS and RTS jumper. To update the firmware, solder a zero-ohm resistor to the BOOT jumper.

8. Code examples

Once you have done all the necessary preparations, it's time to get your click board™ up and running. We have provided examples for mikroC™, mikroBasic™ and mikroPascal™ compilers on our **Libstock** website. Just download them and you are ready to start.



9. Support

MikroElektronika offers **free tech support** [www.mikroe.com/support] until the end of the product's lifetime, so if something goes wrong, we're ready and willing to help!



10. Disclaimer

MikroElektronika assumes no responsibility or liability for any errors or inaccuracies that may appear in the present document. Specification and information contained in the present schematic are subject to change at any time without notice.

Copyright © 2015 MikroElektronika.
All rights reserved.