



MICROCHIP

**BM70 Compact Demo Board (CDB)
User's Guide**

Note the following details of the code protection feature on Microchip devices:

- Microchip products meet the specification contained in their particular Microchip Data Sheet.
- Microchip believes that its family of products is one of the most secure families of its kind on the market today, when used in the intended manner and under normal conditions.
- There are dishonest and possibly illegal methods used to breach the code protection feature. All of these methods, to our knowledge, require using the Microchip products in a manner outside the operating specifications contained in Microchip's Data Sheets. Most likely, the person doing so is engaged in theft of intellectual property.
- Microchip is willing to work with the customer who is concerned about the integrity of their code.
- Neither Microchip nor any other semiconductor manufacturer can guarantee the security of their code. Code protection does not mean that we are guaranteeing the product as "unbreakable."

Code protection is constantly evolving. We at Microchip are committed to continuously improving the code protection features of our products. Attempts to break Microchip's code protection feature may be a violation of the Digital Millennium Copyright Act. If such acts allow unauthorized access to your software or other copyrighted work, you may have a right to sue for relief under that Act.

Information contained in this publication regarding device applications and the like is provided only for your convenience and may be superseded by updates. It is your responsibility to ensure that your application meets with your specifications. MICROCHIP MAKES NO REPRESENTATIONS OR WARRANTIES OF ANY KIND WHETHER EXPRESS OR IMPLIED, WRITTEN OR ORAL, STATUTORY OR OTHERWISE, RELATED TO THE INFORMATION, INCLUDING BUT NOT LIMITED TO ITS CONDITION, QUALITY, PERFORMANCE, MERCHANTABILITY OR FITNESS FOR PURPOSE. Microchip disclaims all liability arising from this information and its use. Use of Microchip devices in life support and/or safety applications is entirely at the buyer's risk, and the buyer agrees to defend, indemnify and hold harmless Microchip from any and all damages, claims, suits, or expenses resulting from such use. No licenses are conveyed, implicitly or otherwise, under any Microchip intellectual property rights unless otherwise stated.

Microchip received ISO/TS-16949:2009 certification for its worldwide headquarters, design and wafer fabrication facilities in Chandler and Tempe, Arizona; Gresham, Oregon and design centers in California and India. The Company's quality system processes and procedures are for its PIC[®] MCUs and dsPIC[®] DSCs, KEELOQ[®] code hopping devices, Serial EEPROMs, microperipherals, nonvolatile memory and analog products. In addition, Microchip's quality system for the design and manufacture of development systems is ISO 9001:2000 certified.

**QUALITY MANAGEMENT SYSTEM
CERTIFIED BY DNV
= ISO/TS 16949 =**

Trademarks

The Microchip name and logo, the Microchip logo, AnyRate, AVR, AVR logo, AVR Freaks, BeaconThings, BitCloud, CryptoMemory, CryptoRF, dsPIC, FlashFlex, flexPWR, Helder, JukeBlox, KEELOQ, KEELOQ logo, Klear, LANCheck, LINK MD, maXStylus, maXTouch, MediaLB, megaAVR, MOST, MOST logo, MPLAB, OptoLyzer, PIC, picoPower, PICSTART, PIC32 logo, Prochip Designer, QTouch, RightTouch, SAM-BA, SpyNIC, SST, SST Logo, SuperFlash, tinyAVR, UNI/O, and XMEGA are registered trademarks of Microchip Technology Incorporated in the U.S.A. and other countries.

ClockWorks, The Embedded Control Solutions Company, EtherSynch, Hyper Speed Control, HyperLight Load, IntelliMOS, mTouch, Precision Edge, and Quiet-Wire are registered trademarks of Microchip Technology Incorporated in the U.S.A.

Adjacent Key Suppression, AKS, Analog-for-the-Digital Age, Any Capacitor, AnyIn, AnyOut, BodyCom, chipKIT, chipKIT logo, CodeGuard, CryptoAuthentication, CryptoCompanion, CryptoController, dsPICDEM, dsPICDEM.net, Dynamic Average Matching, DAM, ECAN, EtherGREEN, In-Circuit Serial Programming, ICSP, Inter-Chip Connectivity, JitterBlocker, KlearNet, KlearNet logo, Mindi, MiWi, motorBench, MPASM, MPF, MPLAB Certified logo, MPLIB, MPLINK, MultiTRAK, NetDetach, Omniscient Code Generation, PICDEM, PICDEM.net, PICkit, PICTail, PureSilicon, QMatrix, RightTouch logo, REAL ICE, Ripple Blocker, SAM-ICE, Serial Quad I/O, SMART-I.S., SQI, SuperSwitcher, SuperSwitcher II, Total Endurance, TSHARC, USBCheck, VariSense, ViewSpan, WiperLock, Wireless DNA, and ZENA are trademarks of Microchip Technology Incorporated in the U.S.A. and other countries.

SQTP is a service mark of Microchip Technology Incorporated in the U.S.A.

Silicon Storage Technology is a registered trademark of Microchip Technology Inc. in other countries.

GestIC is a registered trademark of Microchip Technology Germany II GmbH & Co. KG, a subsidiary of Microchip Technology Inc., in other countries.

All other trademarks mentioned herein are property of their respective companies.

© 2017, Microchip Technology Incorporated, All Rights Reserved.
ISBN: 978-1-5224-2059-0

Object of Declaration: BM70 Compact Demo Board (CDB)

EU Declaration of Conformity

This declaration of conformity is issued by the manufacturer.

The development/evaluation tool is designed to be used for research and development in a laboratory environment. This development/evaluation tool is not a Finished Appliance, nor is it intended for incorporation into Finished Appliances that are made commercially available as single functional units to end users under EU EMC Directive 2004/108/EC and as supported by the European Commission's Guide for the EMC Directive 2004/108/EC (8th February 2010).

This development/evaluation tool complies with EU RoHS2 Directive 2011/65/EU.

This development/evaluation tool, when incorporating wireless and radio-telecom functionality, is in compliance with the essential requirement and other relevant provisions of the R&TTE Directive 1999/5/EC and the FCC rules as stated in the declaration of conformity provided in the module datasheet and the module product page available at www.microchip.com.

For information regarding the exclusive, limited warranties applicable to Microchip products, please see Microchip's standard terms and conditions of sale, which are printed on our sales documentation and available at www.microchip.com.

Signed for and on behalf of Microchip Technology Inc. at Chandler, Arizona, USA.

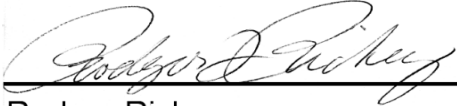

Rodger Richey
Director of Development Tools



Date

BM70 Compact Demo Board (CDB) User's Guide

NOTES:

Table of Contents

Preface	7
Chapter 1. Overview	
1.1 Introduction	11
1.2 BM-70-CDB Description	11
1.3 Features	12
Chapter 2. Interface Description	
2.1 Introduction	13
2.2 BM-70-CDB	13
2.3 Sensor Board	14
Chapter 3. Using BM70 Firmware on BM-70-CDB	
3.1 Introduction	15
3.2 Connecting The BM-70-CDB To A Host PC	15
3.3 BM70 UART Transparent Connection Using Smartdata App	16
Chapter 4. Using RN4870 Firmware on BM-70-CDB	
4.1 Introduction	19
4.2 Connecting The BM-70-CDB To A Host PC	19
4.3 Changing Settings Using ASCII Commands	22
4.4 Connecting To The RN4870 Using SmartDiscover APP	23
4.5 Creating Custom GATT Services	25
4.6 Accessing GATT Service Using UART Commands And SmartDiscover App ..	26
Chapter 5. RN4870 Sensor Board	
5.1 Introduction	29
5.2 Reading Sensor Board Peripheral I/O Ports Using UART Commands	29
5.3 Configuring The RN4870 Module Settings	31
5.4 Sensor Board GATT Service	32
5.5 Transferring Sensor Data Into GATT Service Using Scripting	34
5.6 BLESensorApp Smartphone App	36
5.7 Provision Utility	38
Appendix A. Loading RN4870 Firmware	
A.1 Introduction	43
Appendix B. Loading BM70 Firmware	
B.1 Introduction	47
Appendix C. BM-70-CDB Example Configuration	
C.1 Introduction	51
C.2 Requirements	51

C.3 Setting Configuration Parameters	52
Appendix D. Schematics and BOM	
D.1 Introduction	59
D.2 BM-70-CDB Schematic	60
D.3 BM-70-CDB BOM	61
D.4 RN4870 Sensor Board Schematic	62
D.5 RN4870 Sensor Board BOM	62
Appendix E. Bluetooth Low Energy Primer	
E.1 GAP Roles: Peripheral And Central	65
E.2 GATT Service: Client And Server	65
Appendix F. Sensor Board Script Text	
F.1 Overview	67
F.2 Sensor Board Script	67
Appendix G. Transparent UART	
G.1 Introduction	69
Worldwide Sales and Service	71

Preface

NOTICE TO CUSTOMERS

All documentation becomes dated, and this manual is no exception. Microchip tools and documentation are constantly evolving to meet customer needs, so some actual dialogs and/or tool descriptions may differ from those in this document. Please refer to our website (www.microchip.com) to obtain the latest documentation available.

Documents are identified with a “DS” number. This number is located on the bottom of each page, in front of the page number. The numbering convention for the DS number is “DSXXXXXXXXA”, where “XXXXXXXX” is the document number and “A” is the revision level of the document.

For the most up-to-date information on development tools, see the MPLAB® IDE online help. Select the Help menu, and then Topics to open a list of available online help files.

INTRODUCTION

This chapter contains general information that will be useful to know before using the BM70 Compact Demo Board (CDB). Items discussed in this chapter include:

- [Document Layout](#)
- [Conventions Used in this Guide](#)
- [Recommended Reading](#)
- [The Microchip Website](#)
- [Development Systems Customer Change Notification Service](#)
- [Customer Support](#)
- [Document Revision History](#)

DOCUMENT LAYOUT

This document describes how to use the BM70 Compact Demo Board (CDB) as a development tool to emulate and debug firmware on a target board. The document is organized as follows:

- **Chapter 1. “Overview”** describes the hardware and software requirements of the BM70 Compact Demo Board (CDB).
- **Chapter 2. “Interface Description”** provides the board and interface descriptions of the BM-70-CDB Board and the Sensor Board.
- **Chapter 3. “Using BM70 Firmware on BM-70-CDB”** provides the steps on how to establish a connection to the BM-70-CDB using the BM70 firmware.
- **Chapter 4. “Using RN4870 Firmware on BM-70-CDB”** provides the steps on how to establish a connection to the BM-70-CDB using the RN4870 firmware.
- **Chapter 5. “RN4870 Sensor Board”** demonstrates how to use the RN4870 Sensor Board with BM-70-CDB.
- **Appendix A. “Loading RN4870 Firmware”** provides the steps on how to load the RN4870 firmware to BM-70-CDB using the PC Tool `isupdate.exe`.

- [Appendix B. “Loading BM70 Firmware”](#) provides the steps on how to update the firmware for the BM70 using the PC Tool `isupdate.exe`.
- [Appendix C. “BM-70-CDB Example Configuration”](#) provides the hardware and software requirements to configure the BM70 module.
- [Appendix D. “Schematics and BOM”](#) provides the schematics and the Bill of Materials (BOM) for the BM-70-CDB and the Sensor Board.
- [Appendix E. “Bluetooth Low Energy Primer”](#) provides a brief summary of GAP roles and GATT services.
- [Appendix F. “Sensor Board Script Text”](#) provides an example of a script that can be used to control and communicate with the Sensor Board.
- [Appendix G. “Transparent UART”](#) provides an introduction to the Transparent UART Service.

CONVENTIONS USED IN THIS GUIDE

This manual uses the following documentation conventions:

DOCUMENTATION CONVENTIONS

Description	Represents	Examples
Arial font:		
Italic characters	Referenced books	<i>MPLAB[®] IDE User's Guide</i>
	Emphasized text	...is the <i>only</i> compiler...
Initial caps	A window	the Output window
	A dialog	the Settings dialog
	A menu selection	select Enable Programmer
Quotes	A field name in a window or dialog	“Save project before build”
Underlined, italic text with right angle bracket	A menu path	<u><i>File>Save</i></u>
Bold characters	A dialog button	Click OK
	A tab	Click the Power tab
N'Rnnnn	A number in verilog format, where N is the total number of digits, R is the radix and n is a digit.	4'b0010, 2'hF1
Text in angle brackets < >	A key on the keyboard	Press <Enter>, <F1>
Courier New font:		
Plain Courier New	Sample source code	<code>#define START</code>
	Filenames	<code>autoexec.bat</code>
	File paths	<code>c:\mcc18\h</code>
	Keywords	<code>_asm, _endasm, static</code>
	Command-line options	<code>-Opa+, -Opa-</code>
	Bit values	<code>0, 1</code>
	Constants	<code>0xFF, 'A'</code>
Italic Courier New	A variable argument	<i>file.o</i> , where <i>file</i> can be any valid filename
Square brackets []	Optional arguments	<code>mcc18 [options] file [options]</code>
Curly brackets and pipe character: { }	Choice of mutually exclusive arguments; an OR selection	<code>errorlevel {0 1}</code>
Ellipses...	Replaces repeated text	<code>var_name [, var_name...]</code>
	Represents code supplied by user	<code>void main (void) { ... }</code>

RECOMMENDED READING

This user's guide describes how to use BM70 Compact Demo Board (CDB). Other useful document(s) are listed below. The following Microchip document(s) are recommended as supplemental reference resources.

BM70/71 Bluetooth® Low Energy Module Data Sheet (DS60001372)

This document provides the technical specifications for the BM70/71 module and is available for download from the Microchip website (www.microchip.com).

BM70/71 Bluetooth® Low Energy Module User's Guide (DS50002542)

This document describes how to use the BM70/71 module as a development tool to emulate and debug firmware on a target board.

THE MICROCHIP WEBSITE

Microchip provides online support via our website at www.microchip.com. This website is used as a means to make files and information easily available to customers. Accessible by using your favorite Internet browser, the website contains the following information:

- **Product Support** – Data sheets and errata, application notes and sample programs, design resources, user's guides and hardware support documents, latest software releases and archived software
- **General Technical Support** – Frequently Asked Questions (FAQs), technical support requests, online discussion groups, Microchip consultant program member listing
- **Business of Microchip** – Product selector and ordering guides, latest Microchip press releases, listing of seminars and events; and listings of Microchip sales offices, distributors and factory representatives

DEVELOPMENT SYSTEMS CUSTOMER CHANGE NOTIFICATION SERVICE

Microchip's customer notification service helps keep customers current on Microchip products. Subscribers will receive e-mail notification whenever there are changes, updates, revisions or errata related to a specified product family or development tool of interest.

To register, access the Microchip website at www.microchip.com, click on **Customer Change Notification** and follow the registration instructions.

The Development Systems product group categories are:

- **Compilers** – The latest information on Microchip C compilers and other language tools
- **Emulators** – The latest information on the Microchip MPLAB® REAL ICE™ in-circuit emulator
- **In-Circuit Debuggers** – The latest information on the Microchip in-circuit debugger, MPLAB ICD 3
- **MPLAB X IDE** – The latest information on Microchip MPLAB X IDE, the Windows® Integrated Development Environment for development systems tools
- **Programmers** – The latest information on Microchip programmers including the PICKit™ 3 development programmer

CUSTOMER SUPPORT

Users of Microchip products can receive assistance through several channels:

- Distributor or Representative
- Local Sales Office
- Field Application Engineer (FAE)
- Technical Support

Customers should contact their distributor, representative or field application engineer (FAE) for support. Local sales offices are also available to help customers. A listing of sales offices and locations is included in the back of this document.

Technical support is available through the website at:

<http://www.microchip.com/support>.

DOCUMENT REVISION HISTORY

Revision A (August 2017)

This is the initial release of this document.

Chapter 1. Overview

1.1 INTRODUCTION

This document describes the hardware and software requirements for the BM70 Compact Demo Board (CDB), part number: BM-70-CDB. The BM-70-CDB enables the designer to evaluate and demonstrate the capabilities of the BM70 module.

The BM-70-CDB includes the following key features:

- Integrated configuration and programming interface
- LED and push button for prototype user inputs
- MCP2200 USB to UART bridge for plug-and-play connectivity to host PC

An additional RN4870 Sensor Board is included to demonstrate peripheral access using Bluetooth Low Energy (BLE), refer to [Figure 1-1](#). In addition to BM-70-CDB hardware, the following smartphone applications from Microchip are available on the Apple iTunes® and Google Play™ Store to demonstrate the capabilities of the BM70 module:

- SmartDiscover
- SmartData
- BLESensorApp

For more information on the BM70, refer to the “*BM70/71 Bluetooth® Low Energy Module Data Sheet*” (DS60001372) and the “*BM70/71 Bluetooth® Low Energy Module User's Guide*” (DS50002542), which are available for download from the Microchip product web page at www.microchip.com/BM70.

1.2 BM-70-CDB DESCRIPTION

The BM-70-CDB is a versatile evaluation board for developing and prototyping Bluetooth Low Energy data applications. It can be powered via USB host or through the coin cell battery. The BM-70-CDB uses the BM70, a fully certified Bluetooth 4.2 Low Energy module. The BM-70-CDB provides a USB connectivity to connect to a host PC, a PC terminal utility and smartphone apps to evaluate both BLE serial data connections and custom BLE services.

BM70 Compact Demo Board (CDB) User's Guide

FIGURE 1-1: BM-70-CDB AND SENSOR BOARD

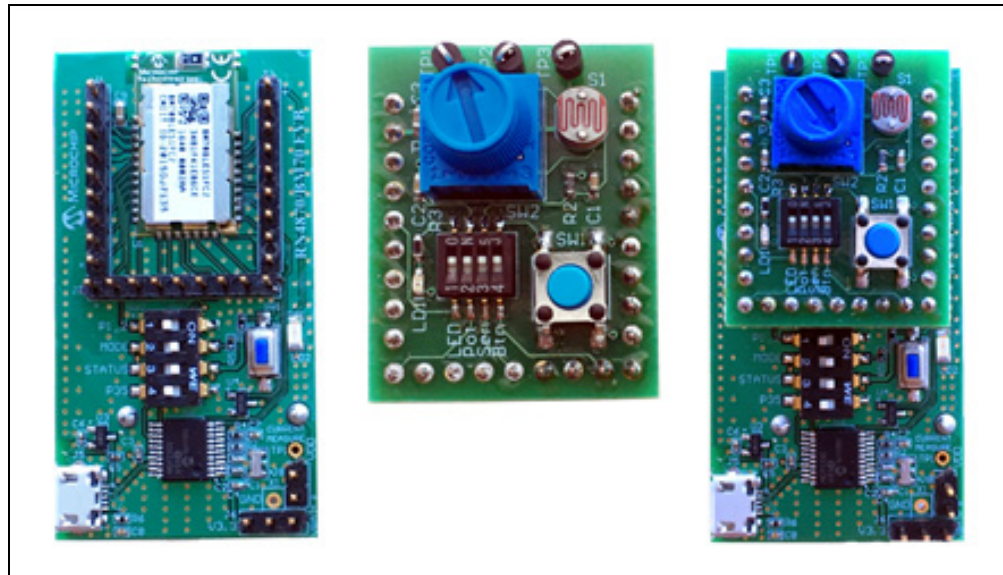

1.3 FEATURES

The BM-70-CDB has the following features:

- Fully certified Bluetooth Low Energy 4.2 RF module
- On-Board Dual In-Line Package (DIP) switch block to set operating modes
- Embedded MCP2200 USB-UART bridge which provides programming interface to update firmware and configuration settings

Chapter 2. Interface Description

2.1 INTRODUCTION

This chapter provides details on the components and the interface for the following boards:

- [BM-70-CDB](#)
- [Sensor Board](#)

2.2 BM-70-CDB

The BM-70-CDB components are represented in [Figure 2-1](#). The CDB can be used in Standalone mode powered by either an external USB or a coin cell battery.

FIGURE 2-1: BM-70-CDB

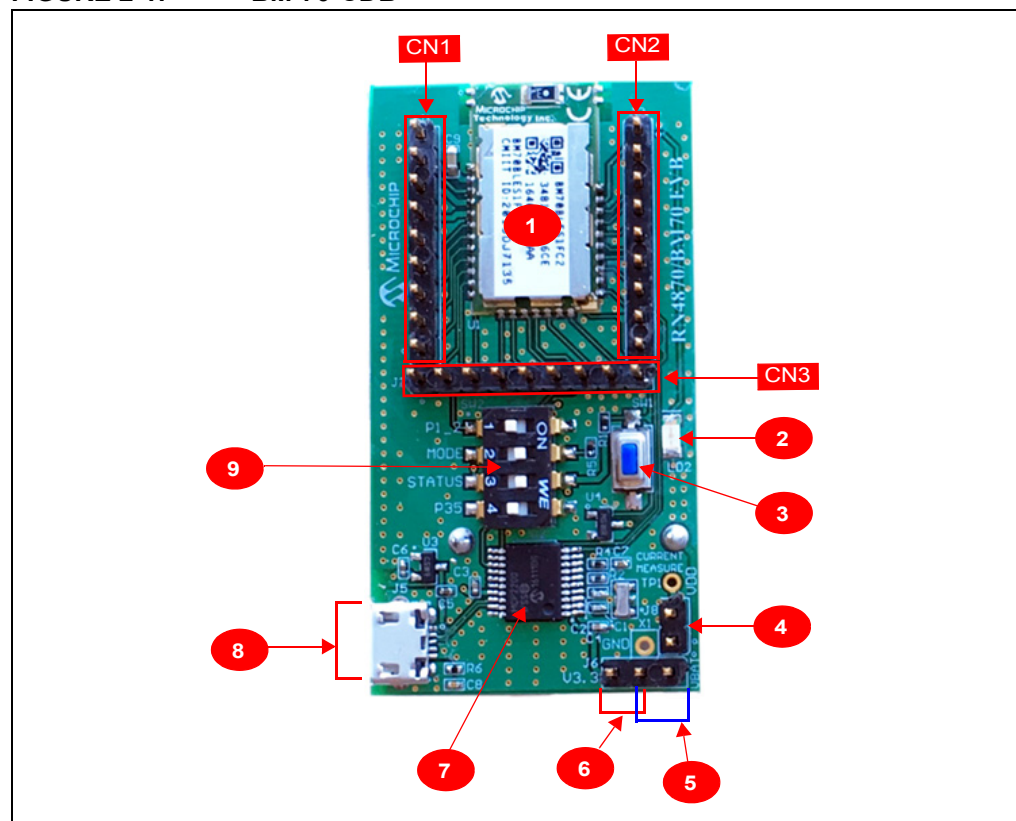

2.2.1 Interface Description

1. BM70 module
2. Status indicator LED (LD2); For blink rate descriptions, refer to the “*BM70/71 Bluetooth® Low Energy Module Data Sheet*” (DS60001372)
3. Push button for hardware Reset (SW1)
4. Current measurement test point (J8)

BM70 Compact Demo Board (CDB) User's Guide

- Header pins for coin cell battery connection (J6, close Pin 1 and Pin 2)
- Header pins for USB power (J6, close Pin 2 and Pin 3)
- MCP2200 - USB to UART bridge
- Micro-USB connector
- DIP Switch block (SW2)
 - Switch 1: P1_2 GPIO
 - Switch 2: P2_0 programming mode
 - Switch 3: LD2 status LED enable/disable
 - Switch 4: P35 GPIO

CN1, CN2, and CN3 are header pins to the BM70 module pins. The header pins are used to connect to the Sensor Board or as test points.

Note: While updating the firmware on BM-70-CDB, ensure that the J6 jumper (Pin 2 and Pin 3) and J8 jumper (current measurement test point) are closed. Do not interrupt jumpers J6 and J8 during firmware update, otherwise the firmware can be corrupted.

2.3 SENSOR BOARD

The BM-70-CDB kit comes with the Sensor Board to demonstrate the peripheral I/O capabilities of the BM70. The Sensor Board components are illustrated in [Figure 2-2](#).

The Sensor Board is an accessory designed for the BM-70-CDB to demonstrate digital and analog I/O capabilities over Bluetooth Low Energy connections. In order to use the Sensor Board with the BM-70-CDB, configuration must be done as described in [Chapter 5. "RN4870 Sensor Board"](#).

FIGURE 2-2: RN4870 SENSOR BOARD

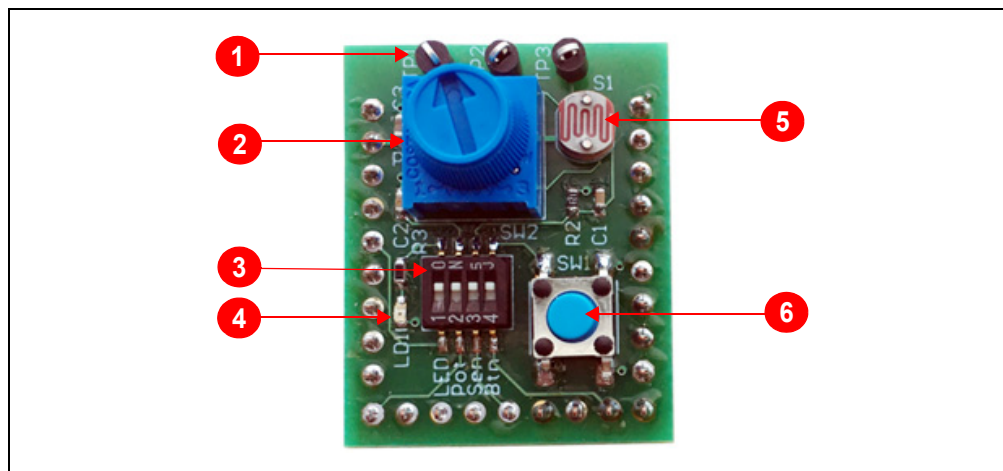

2.3.1 Interface Descriptions

- Test Point for ADC channels of the BM70 module
- Variable Resistor to drive ADC0 input
- DIP Switch block to connect or disconnect sensors from the BM70 module
- LED connected to pin P22
- Light Sensor connected to ADC1 input
- Push Button connected to PIO2

Note: Turn ON all the switches on DIP switch block SW2 before running the demos in this document.

Chapter 3. Using BM70 Firmware on BM-70-CDB

3.1 INTRODUCTION

The simplest method to program the BM70 module on the BM-70-CDB is to connect it to a PC host that supports USB CDC virtual COM (serial) ports.

Using BM70 firmware on CDB, the user data can be transferred to a remote device over Transparent UART (Refer to [Appendix G. “Transparent UART”](#)). This section shows the procedure on how to connect to a smartphone via the BM70 and open a Transparent UART data pipe to communicate with the smartphone app.

To interact directly with the BM70 module, the following software are needed:

- PC Host supporting USB CDC virtual serial port
 - The BM-70-CDB uses the MCP2200 USB/UART bridge. The drivers can be downloaded from the Microchip website at www.microchip.com/MCP2200.
- Terminal Emulator Application
 - TeraTerm or CoolTerm is recommended.
- Microchip SmartData App for iOS®
 - Available on App Store® (for iOS).

Note 1: At the time of publication, the BM70 modules are released with firmware version 1.03. The latest firmware version for BM70 is available for download from the Microchip product web page at www.microchip.com/BM70.

2: Refer to [Appendix B. “Loading BM70 Firmware”](#) on how to program the firmware on BM70 and [Appendix C. “BM-70-CDB Example Configuration”](#) on how to configure BM70 after programming the firmware.

3.2 CONNECTING THE BM-70-CDB TO A HOST PC

To connect the BM-70-CDB to a host PC, perform the following steps:

1. Configure the BM-70-CDB as follows:
 - Pin 2 and Pin 3 on J6 are closed to select the USB power option
 - J8 is closed
 - Operating mode switch (Switch 2 on SW2) is in position 2 to enable application mode.
2. Connect the BM-70-CDB to the host PC using Micro-USB cable.
 - Verify that the virtual COM port is enumerated on the host PC. If the COM port does not enumerate, the MCP2200 drivers may need to be downloaded to the host PC. The drivers can be downloaded from the Microchip website at www.microchip.com/MCP2200.
 - Press **Reset** button (SW1) and verify that LD2 is flashing slowly.
3. Start the Terminal Emulator software. In this example, TeraTerm is used. Configure the enumerated COM port as shown in [Figure 3-1](#).

BM70 Compact Demo Board (CDB) User's Guide

FIGURE 3-1: COM PORT SETTINGS FOR TERMINAL EMULATOR

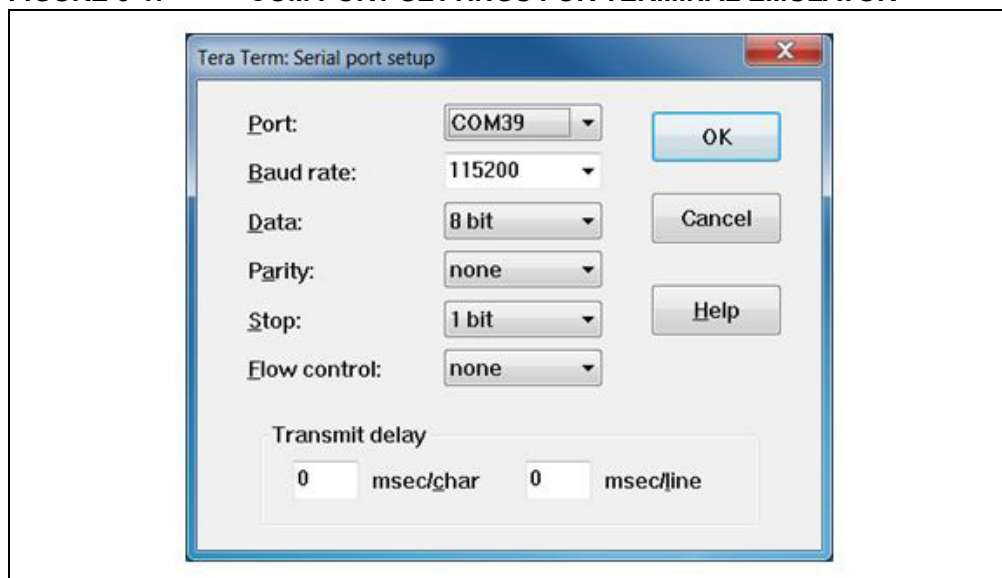

3.3 BM70 UART TRANSPARENT CONNECTION USING SMARTDATA APP

To establish a UART Transparent connection on the BM-70-CDB using Bluetooth SmartData App, perform the following steps:

1. On your Apple device, download and install the SmartData App by Microchip Technology Inc. from iTunes App Store.
2. Open a serial port terminal to the BM70 module by following the steps in [Section 3.2 “Connecting The BM-70-CDB To A Host PC”](#).
3. Turn ON Bluetooth and open SmartData App on the iOS device.
4. The SmartData automatically scans for BLE modules in the vicinity upon opening. From the list of scanned devices, Click “BLE-SPP” (or any user-defined name) from the scan list in SmartData App to connect to the module. Refer to [Figure 3-2](#).

Using BM70 Firmware on BM-70-CDB

FIGURE 3-2: CONNECT TO BM70 MODULE USING SMARTDATA APP

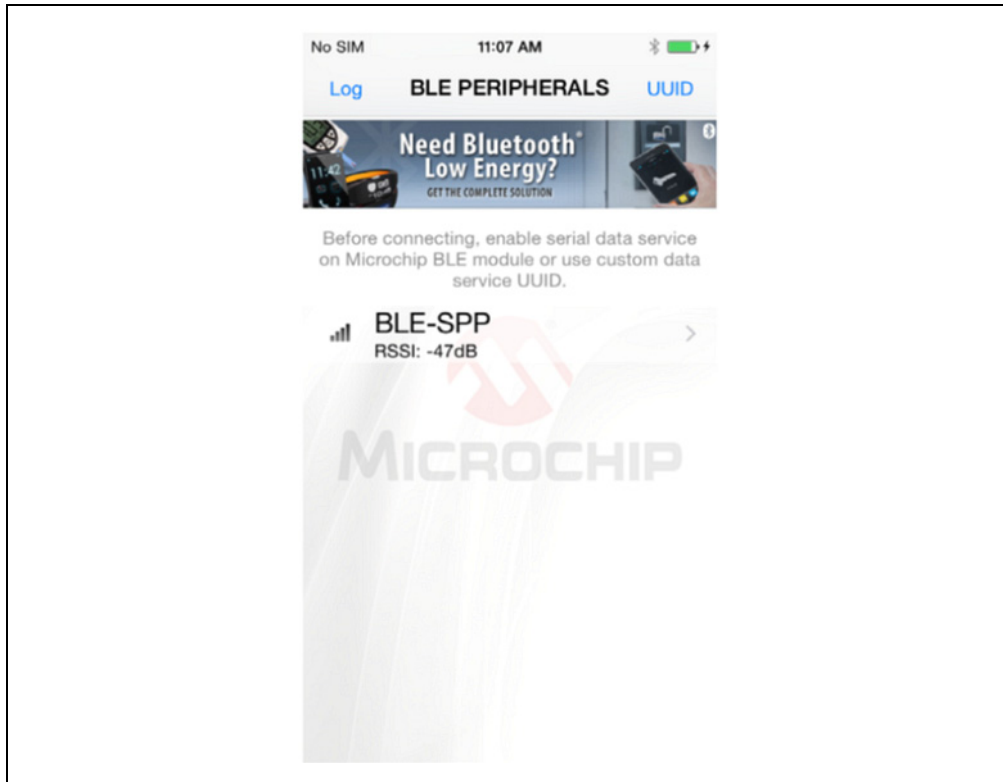

5. After the connection is established with the BM70 module, select the **Serial Data** tab in the SmartData App.
6. Enter example text in the first dialog box of the **Serial Data** tab and click **Send**. The example text displays in the serial terminal emulator on the host PC.
7. Type any data on the serial terminal of the BM70 to send data from BM70 to SmartData App. The data sent from the host PC is displayed in the Receive box of the SmartData app. Refer to [Figure 3-3](#) and [Figure 3-4](#).

BM70 Compact Demo Board (CDB) User's Guide

FIGURE 3-3: DATA EXCHANGE ON SMARTDATA APP WITH BM70 MODULE



FIGURE 3-4: DATA EXCHANGE ON BM70 UART TERMINAL EMULATOR WITH SMARTDATA APP

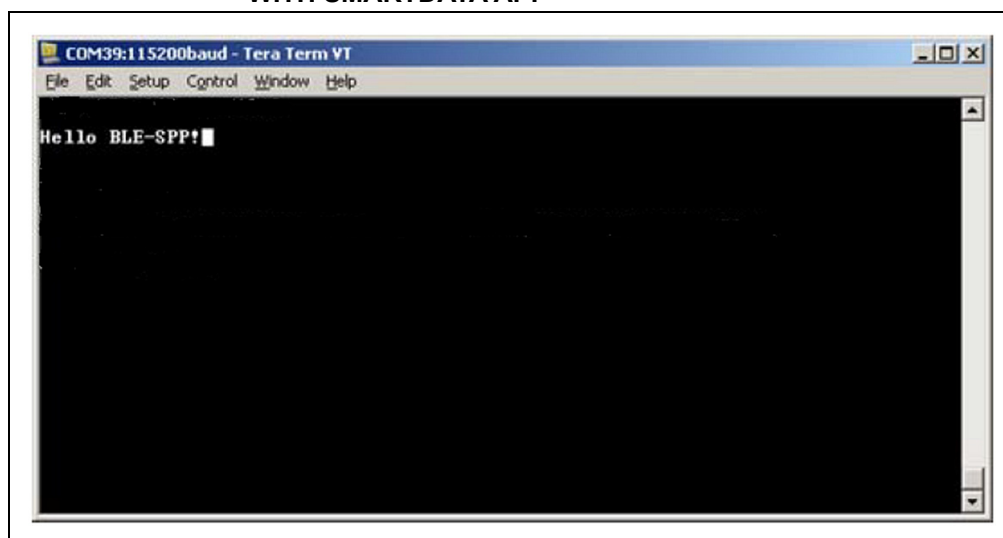

Chapter 4. Using RN4870 Firmware on BM-70-CDB

4.1 INTRODUCTION

The BM70 module on the BM-70-CDB can be loaded with the RN4870 firmware and operated as a RN4870 module for evaluation and development. Refer to [Appendix A. “Loading RN4870 Firmware”](#) for the procedure on how to load the RN4870 firmware onto the BM70 module.

The BM-70-CDB module is programmed with RN4870 firmware. In this section, the module is referred to as RN4870 and the hardware board as BM-70-CDB.

The simplest method to access the BM-70-CDB is to connect it to a PC host that supports USB CDC virtual COM ports. To interact directly with the BM-70-CDB, the following software are needed:

- PC Host supporting USB CDC virtual serial port
 - The BM-70-CDB uses MCP2200 USB to UART bridge. The drivers can be downloaded from the product web page at www.microchip.com/MCP2200.
- Terminal Emulator Application
 - TeraTerm or CoolTerm is recommended
- Microchip SmartDiscover App for iOS or Android
 - Available on App Store (for iOS) or Google Play Store (Android)
- RN4870 Sensor Board Support Package (RN4870-Sensor-Board-Support.zip)
 - This is a collection of files and utilities to assist in configuring the Sensor Board. The files can be downloaded from the Microchip product web page at www.microchip.com/RN4870.

4.2 CONNECTING THE BM-70-CDB TO A HOST PC

To connect the BM-70-CDB to a host PC, perform the following steps:

1. Configure the BM-70-CDB as follows:
 - Pin 2 and Pin 3 on J6 are closed to select USB power option
 - J8 is closed
 - Operating mode switch (Switch 2 on SW2) is in position 2 to enable application mode
 - Switch 3 on SW2 is in position 3 to enable LD2 (Blue LED)
2. Connect the BM-70-CDB to the host PC using Micro-USB cable and perform the following steps:
 - Verify that the virtual COM port is enumerated on the host PC. If the COM port does not enumerate, the MCP2200 drivers may be missing from the host PC. The drivers can be downloaded from the Microchip website at www.microchip.com/MCP2200.
 - Press **Reset** button (SW1) and verify that LD2 is flashing slowly
3. Start the Terminal Emulator software. In this example, TeraTerm is used. Configure the enumerated COM port as shown in [Figure 4-1](#).

BM70 Compact Demo Board (CDB) User's Guide

FIGURE 4-1: COM PORT SETTINGS FOR TERMINAL EMULATOR

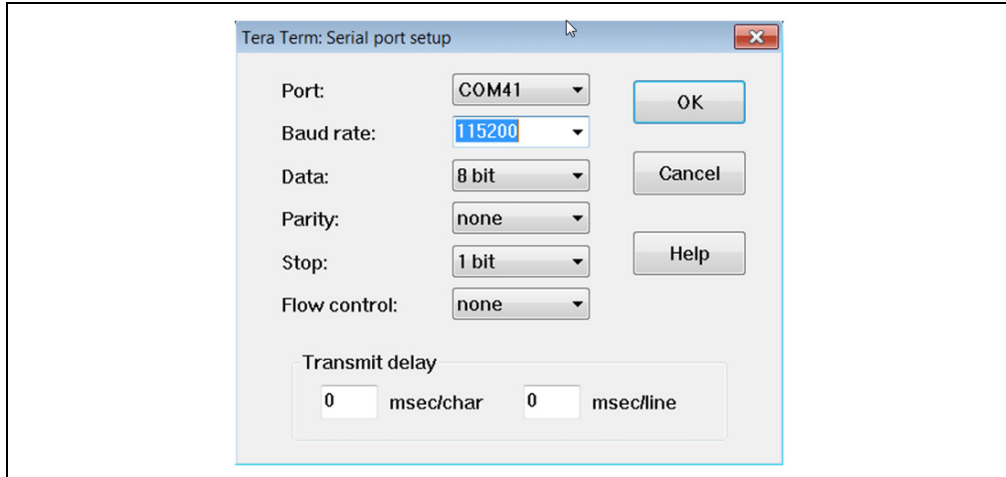

4. Enter Command mode by sending the command escape sequence \$\$\$\$. Pressing the dollar sign (\$) three times puts the RN4870 into Command mode and displays the `CMD>` prompt. Enable the 'local echo' feature by pressing +, which echoes the character entered by the user on the serial emulator window. The ECHO ON response is displayed as shown in [Figure 4-2](#).

FIGURE 4-2: COMMAND PROMPT AND ECHO ON RESPONSE

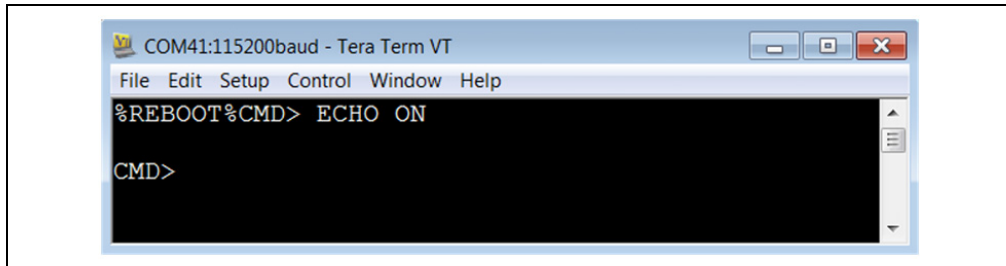

5. To display the basic configuration settings, press letter <D> followed by the <Enter> key (\r) as shown in [Figure 4-3](#). Refer to the "RN4870/71 Bluetooth® Low Energy Module User's Guide" (DS50002466) for a detailed explanation of the commands.

FIGURE 4-3: RESULTS OF D TO DISPLAY BASIC CONFIGURATION

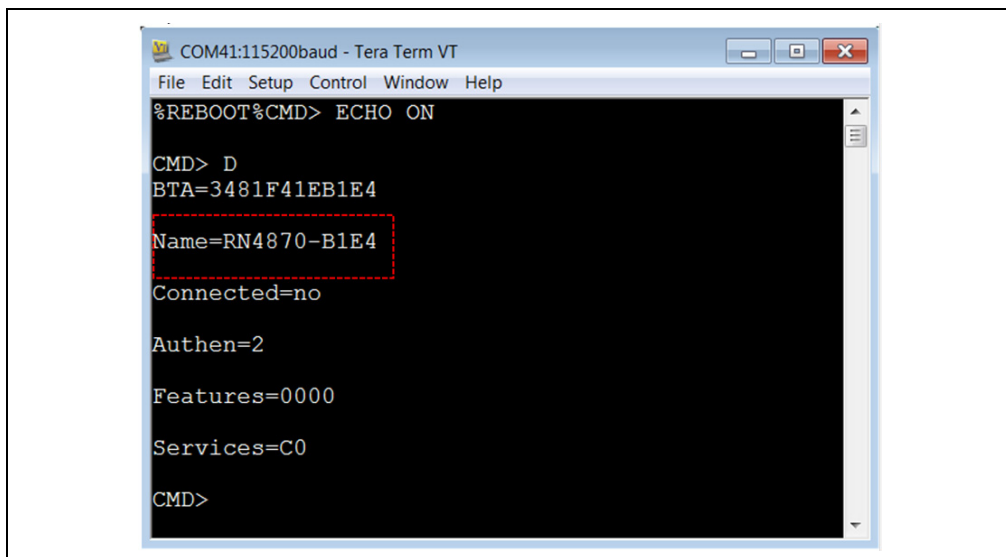

Using RN4870 Firmware on BM-70-CDB

- SmartDiscover App from Microchip can be used to demonstrate the RN4870 features. Refer to [Figure 4-4](#) for an example of the SmartDiscover App icon. The iOS version of SmartDiscover App is referred in this document.

FIGURE 4-4: SMARTDISCOVER APP ICON

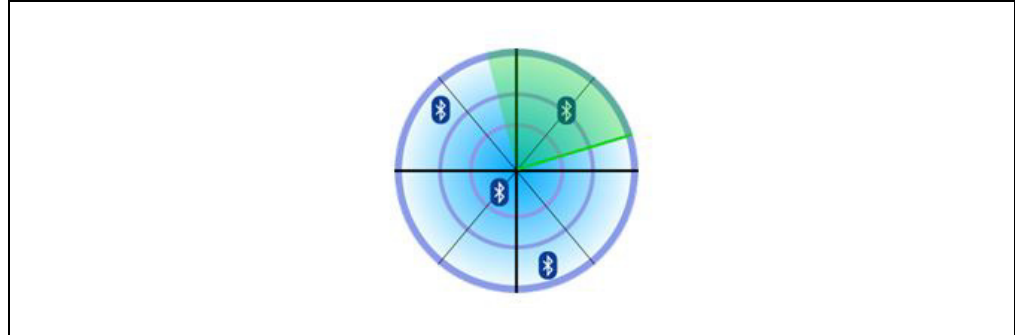

- Once SmartDiscover App is opened on your smartphone, it discovers the RN4870 peripherals as shown in [Figure 4-5](#).

FIGURE 4-5: SMARTDISCOVER APP DISCOVERS RN4870 PERIPHERAL

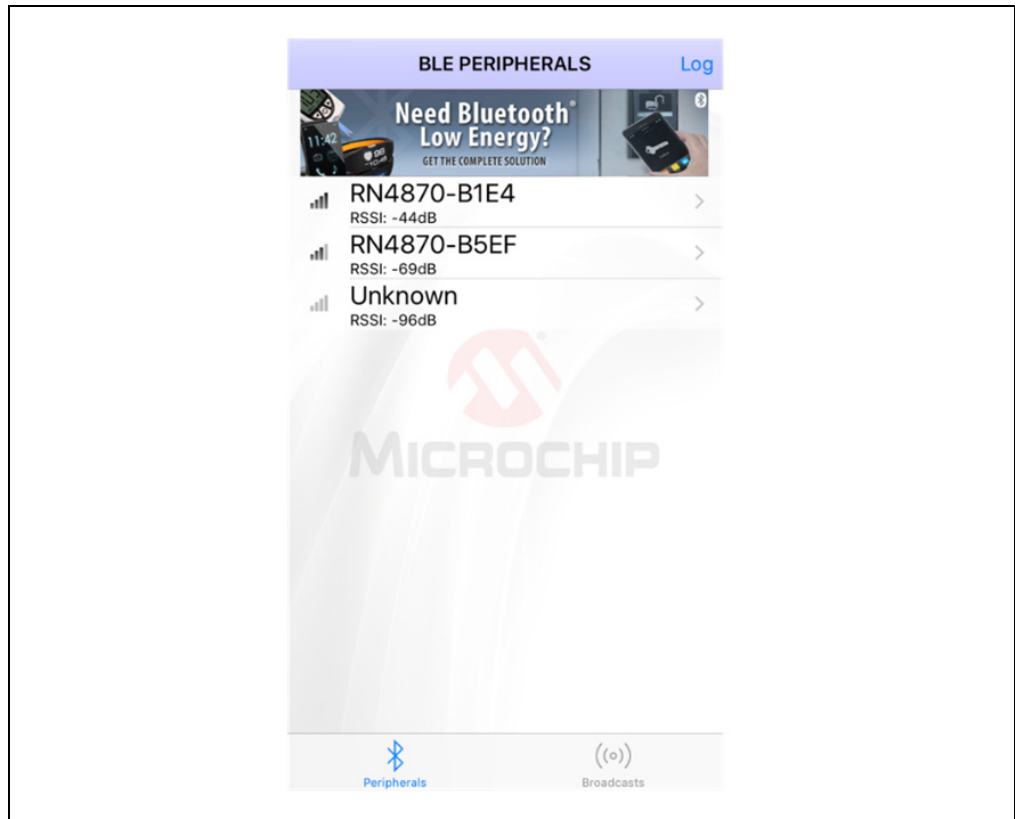

BM70 Compact Demo Board (CDB) User's Guide

4.3 CHANGING SETTINGS USING ASCII COMMANDS

The RN4870 firmware is shipped with a default configuration which includes two services (Transparent UART service and Device Info Service) as noted by the result of the previous command `D` (displays basic configuration). The list of services is indicated as `Services = C0`. Refer to the “RN4870/71 Bluetooth® Low Energy Module User's Guide” (DS50002466) for a bitmap of services. The RN4870 can be discovered using Bluetooth SmartDiscover App. The SmartDiscover App is available in the iTunes Store and the Google Play Store.

To enable built-in services and connection to the RN4870, perform the following steps:

1. Connect the BM-70-CDB to the host PC USB port:
 - Using Terminal Emulator, open the COM port enumerated for the BM-70-CDB.
 - Type `$$$` to enter Command mode.
 - Enter `+` to turn ON ECHO. Refer to [Figure 4-2](#).
2. To change the default name, send the following commands:
 - `S-,BLE` to create a unique serialized name based on Bluetooth (BT) address of the device.
 - `R,1` to reboot the module and enable the configuration commands to take effect. Refer to [Figure 4-6](#).

FIGURE 4-6: s- COMMAND EXAMPLE

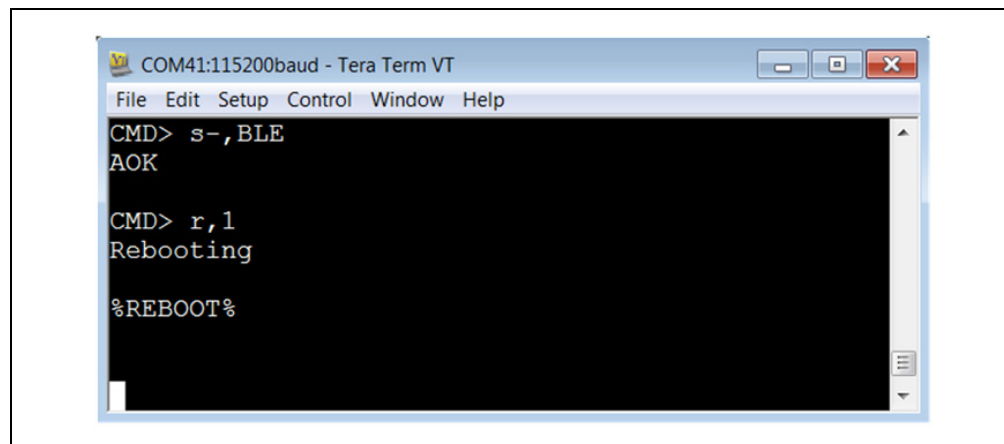

```
COM41:115200baud - Tera Term VT
File Edit Setup Control Window Help
CMD> s-,BLE
AOK

CMD> r,1
Rebooting

%REBOOT%
```

3. Verify that the changes made using the `s-` command are saved by the reboot with the following steps:
 - Type `$$$` to enter Command mode.
 - Enter `+` to turn ON local echo.
 - Issue command `D` to display the settings.
 - Verify that the name of the device is BLE-b1b0, where b1b0 are the low order bytes of the BT address. In this example, the Bluetooth is set to BLE-B1E4. Refer to [Figure 4-7](#).

FIGURE 4-7: CONFIRM NEW SETTINGS IN COMMAND MODE

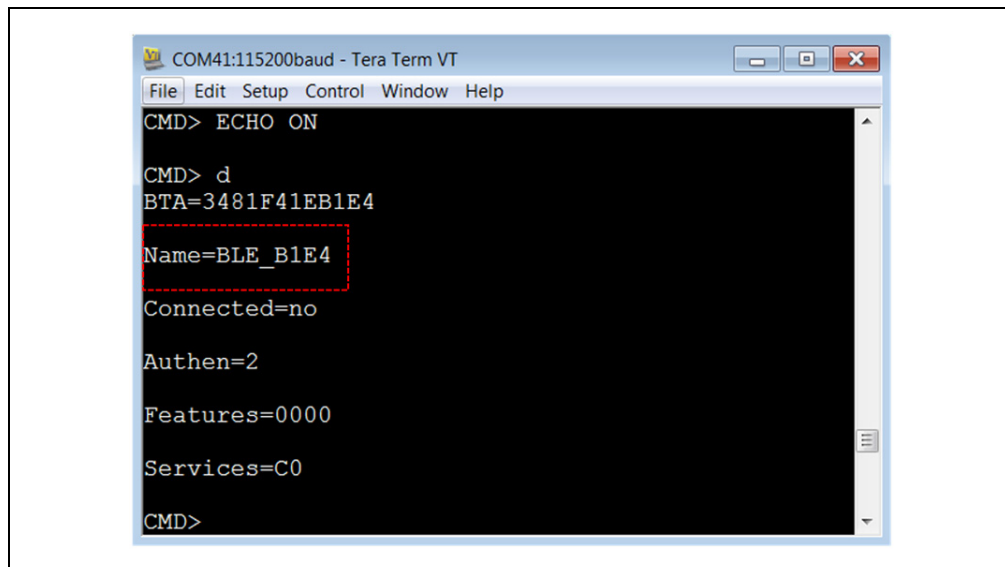

4.4 CONNECTING TO THE RN4870 USING SMARTDISCOVER APP

To connect the RN4870 using SmartDiscover App, perform the following steps:

1. Configure the RN4870 according to the steps listed in [Section 4.3 “Changing Settings Using ASCII Commands”](#). Connect it to the host PC and type \$\$\$ to enter the Command mode.
2. Launch the SmartDiscover App. Refer to [Figure 4-8](#) on how to demonstrate the SmartDiscover App on an iOS device.

FIGURE 4-8: SMARTDISCOVER (IOS)

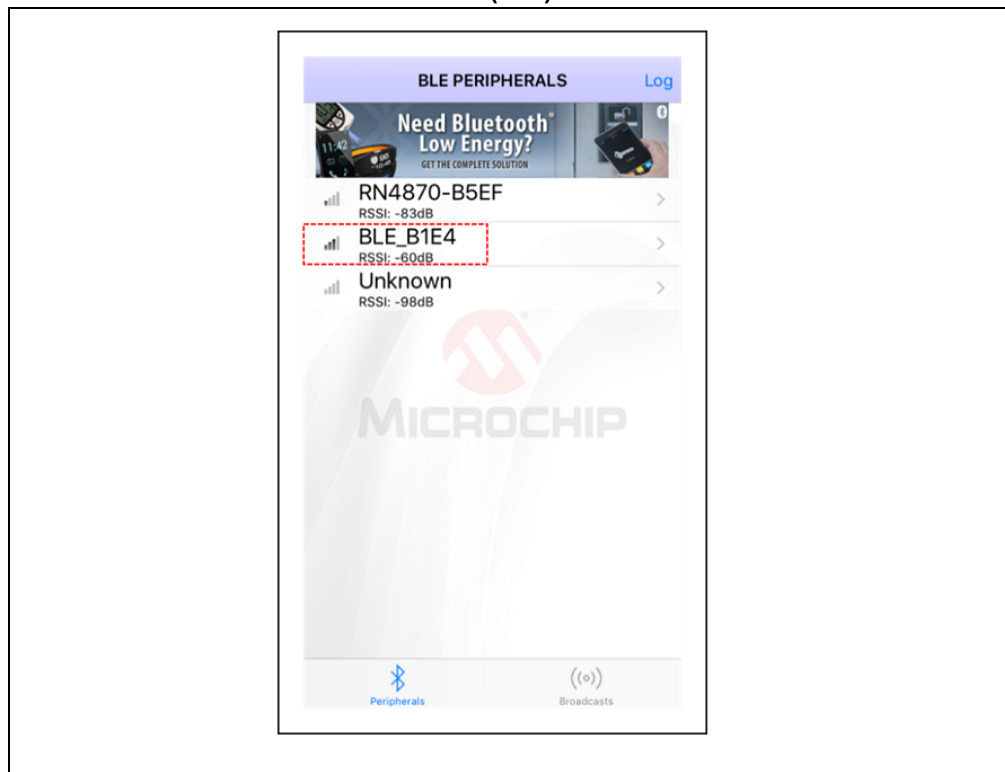

BM70 Compact Demo Board (CDB) User's Guide

3. Verify that the RN4870 device name, BLE-b1b0, is displayed. In this example, the device name is BLE-B1E4 as shown in [Figure 4-8](#).
4. Click the RN4870 device from the list to initiate a connection.
5. Ensure that the connection is established. The GATT service view is illustrated in [Figure 4-9](#). The connection is also verified by the `%CONNECT, 1, <MAC>` status message returned by the RN4870/71 UART. The `<MAC>` is the address of the remote BT device that initiated the connection. The response in the terminal emulator is shown in [Figure 4-10](#).

FIGURE 4-9: GATT SERVICE VIEW WHEN CONNECTED

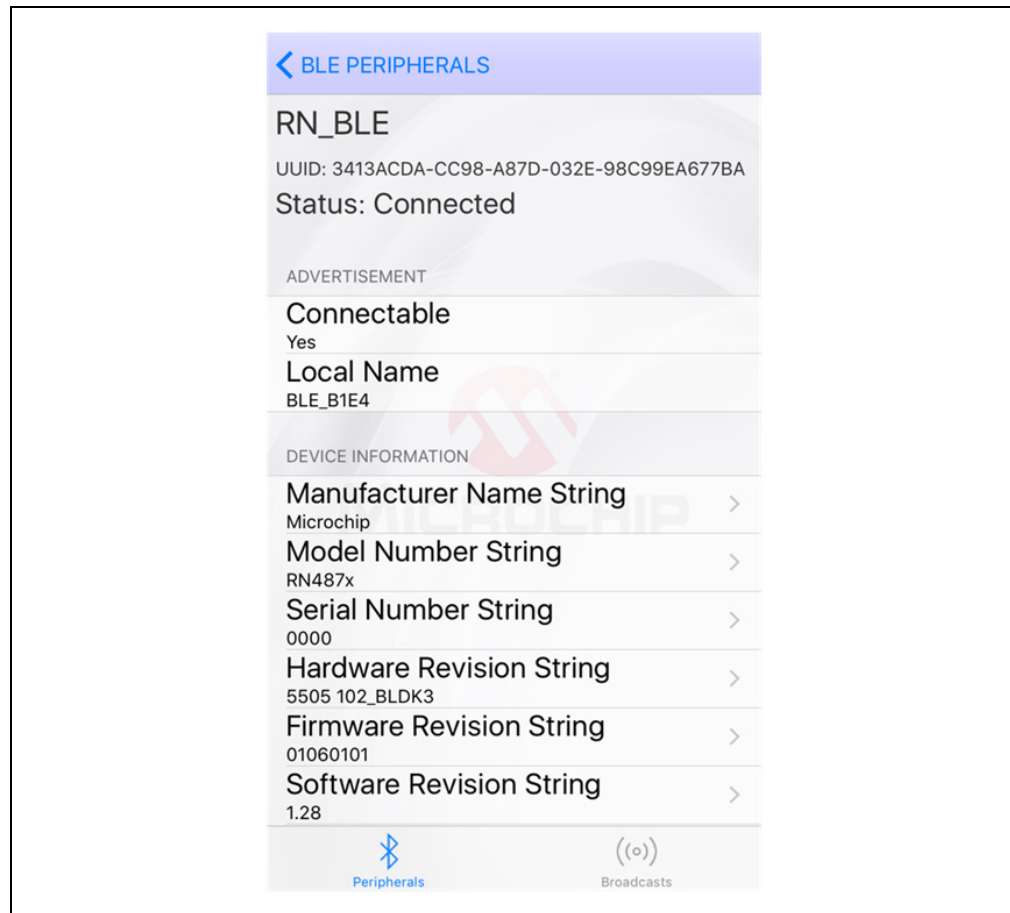
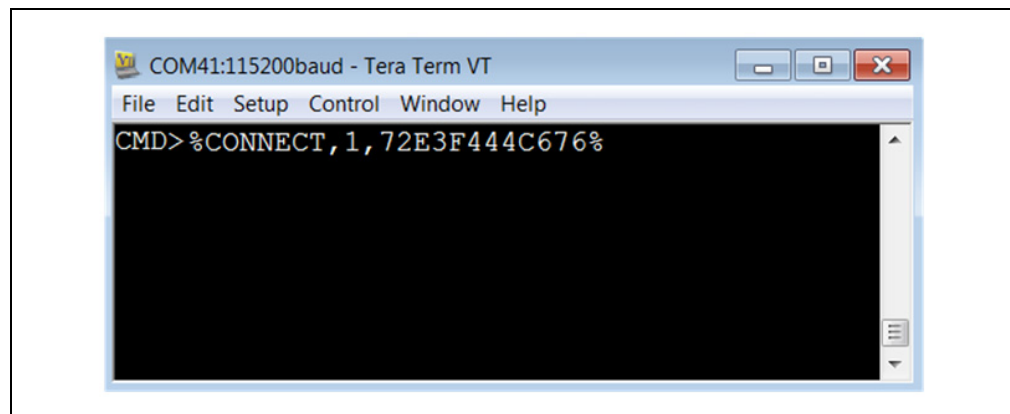

FIGURE 4-10: CONNECTED STATUS MESSAGE



4.5 CREATING CUSTOM GATT SERVICES

The RN4870 module supports custom (or private) GATT services. Public GATT services are defined by specifications published by the Bluetooth Special Interest Group (SIG). Private GATT services are defined by the user to host information stored in the GATT characteristics. For more information on GATT services, refer to [Appendix E. “Bluetooth Low Energy Primer”](#).

To create a private GATT service, enter the configuration commands listed in Step 3 below. The commands can be entered as shown in this user guide, or copied from configuration files and pasted into the terminal emulator. The configuration text files are included in the RN4870 Sensor Board Support package that is available for download from the Microchip product web page at www.microchip.com/RN4870.

1. Connect the BM-70-CDB to the host PC USB port
 - Using Terminal Emulator, open the COM port to the RN4870
 - Type \$\$\$ to enter Command mode
 - Enter + to turn ON ECHO.
2. Set Factory Default values
 - Enter PZ to clear all services and characteristics
 - Enter SF, 1
 - Verify that the module reboots after the command is entered.
3. Create the private GATT service with three characteristics by entering the following commands:

```
PS, 4D6963726F636869702D524E34383730
PC, BF3FBD80063F11E59E690002A5D5C501, 02, 02
PC, BF3FBD80063F11E59E690002A5D5C502, 02, 02
PC, BF3FBD80063F11E59E690002A5D5C503, 18, 04
```

These commands can be entered manually by typing each line followed by the <Enter> key from the file 3.4-GATT-service.txt, or each line copied and pasted one by one into the terminal emulator.

Command PS creates the GATT service, identified by the 16-byte private UUID: 4D6963726F636869702D524E34383730. This command must be called before command PC.

Command PC creates the private characteristics. Each characteristic is identified by the following UUIDs:

```
BF3FBD80063F11E59E690002A5D5C501,
BF3FBD80063F11E59E690002A5D5C502,
BF3FBD80063F11E59E690002A5D5C503.
```

Command PC expects three parameters. The first parameter is the UUID, the second parameter is the characteristic property (refer to [Table E-1](#) in [Appendix E. “Bluetooth Low Energy Primer”](#)), and the third parameter is the size of the data of the characteristic.

4. Reboot the module using command R, 1 to ensure that the new GATT service takes effect.
5. Verify that the GATT service is correctly configured.
 - Enter Command mode (\$\$\$) after rebooting the module.
 - Issue the LS command to list the GATT server services and their characteristics. The response is illustrated in [Figure 4-11](#).

BM70 Compact Demo Board (CDB) User's Guide

FIGURE 4-11: PRIVATE SERVICES DISPLAY FROM `LS` COMMAND

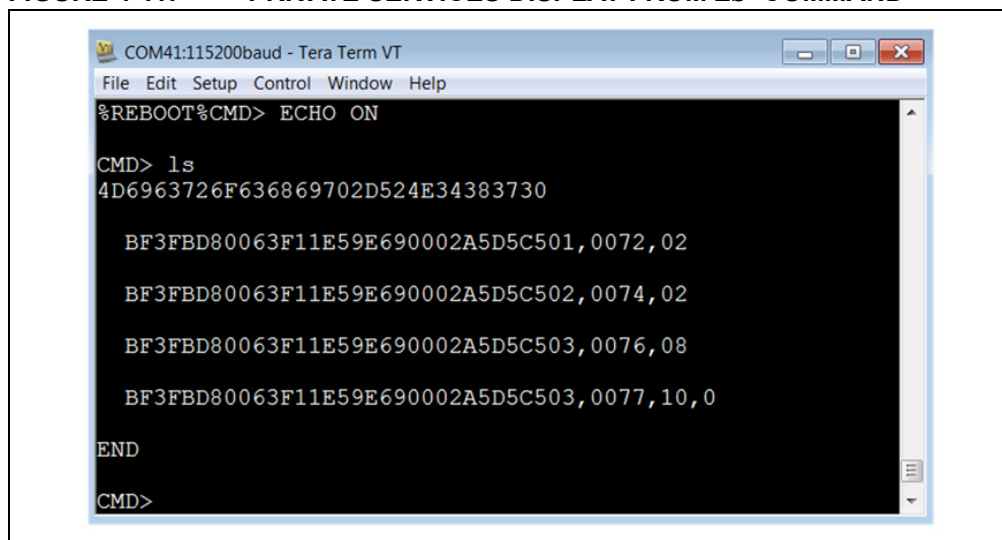

```
COM41:115200baud - Tera Term VT
File Edit Setup Control Window Help
%REBOOT%CMD> ECHO ON

CMD> ls
4D6963726F636869702D524E34383730

BF3FBD80063F11E59E690002A5D5C501,0072,02
BF3FBD80063F11E59E690002A5D5C502,0074,02
BF3FBD80063F11E59E690002A5D5C503,0076,08
BF3FBD80063F11E59E690002A5D5C503,0077,10,0

END
CMD>
```

6. The result of the command `LS` is shown in [Figure 4-11](#). A custom GATT service (UUID: 4D6963726F636869702D524E34383730) with three characteristics identified by low-order bytes C501, C502 and C503 from the 128-bit UUID. A 16-bit handle is assigned to each characteristic. Handles are used to reference and identify 128-bit characteristic UUIDs more efficiently in the GATT service. Note that there are two references for C503 characteristic. In the first case, in reference 0076, the property value 08 has the write property enabled (refer to [Table E-1](#) in [Appendix E. “Bluetooth Low Energy Primer”](#)). Likewise, reference 0077 has the notification property 10 enabled. This means that to write a value to characteristic C503, reference 0076 is used. To enable Client notifications on this characteristic, reference 0077 is used.

4.6 ACCESSING GATT SERVICE USING UART COMMANDS AND SMARTDISCOVER APP

The following examples show how to read and write GATT characteristic values by using UART commands:

1. To write a value to the GATT Server characteristic C501, use the Server Handle Write (`SHW`) command with handle (for example, 0072) as first parameter, following by hex-byte values as shown in [Figure 4-12](#).
2. To read a value from the GATT Server characteristic C501, use the Server Handle Read (`SHR`) command with handle (for example, 0072) as first parameter, following by hex-byte values as shown in [Figure 4-12](#).

FIGURE 4-12: WRITING AND READING GATT VALUE BY HANDLE REFERENCE

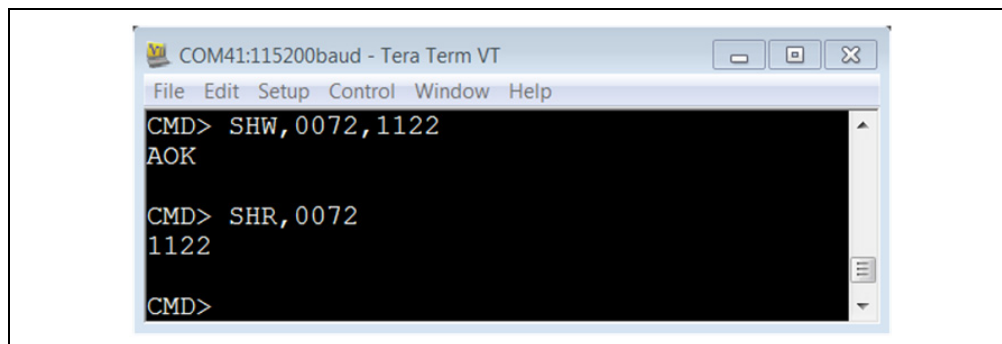

```
COM41:115200baud - Tera Term VT
File Edit Setup Control Window Help
CMD> SHW,0072,1122
AOK

CMD> SHR,0072
1122

CMD>
```

Using RN4870 Firmware on BM-70-CDB

- It is also possible to access the GATT server over a Bluetooth Low Energy connection using SmartDiscover App. Launch the SmartDiscover App and connect to the RN4870 configured with the private GATT as shown in [Section 4.5 “Creating Custom GATT Services”](#). In this example, the device “BLE-B1E4” is used. Follow the steps in [Figure 4-13](#) to read the value of the GATT characteristic C501. In Step 1, click on the name of your device (BLE-B1E4 >), in Step 2 click on the UUID (BF3FBD80063F11E59E69690002A5D5C501 >), and in Step 3 click on **Read**. The characteristic value is read from the RN4870 into the SmartDiscover App.

FIGURE 4-13: USING SMARTDISCOVER TO READ GATT CHARACTERISTIC VALUE

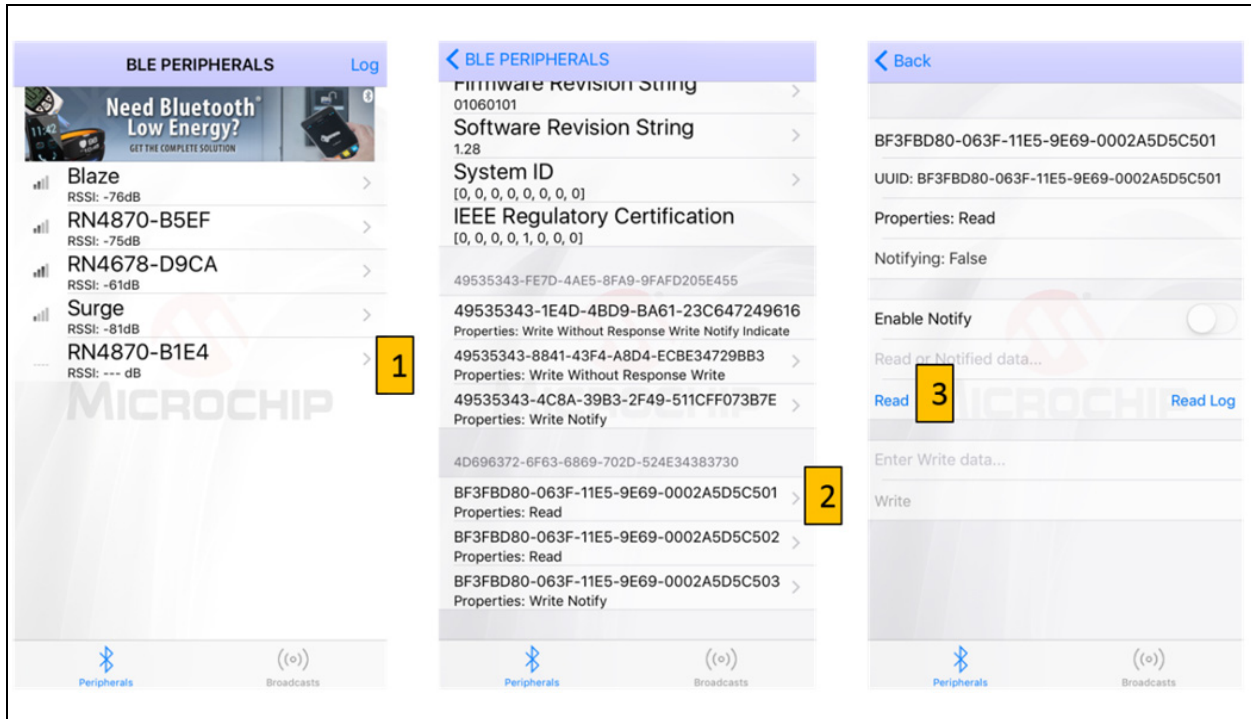

BM70 Compact Demo Board (CDB) User's Guide

NOTES:

Chapter 5. RN4870 Sensor Board

5.1 INTRODUCTION

This chapter demonstrates how to use RN4870 Sensor Board with BM-70-CDB which is loaded with RN4870 firmware. Once RN4870 is configured to enable the Sensor Board peripherals, the sensor values can be read locally using the RN4870 UART commands or from the BLESensor smartphone app over GATT. The configuration procedure is as follows:

1. Configure Peripheral I/O port to sensors using command `SW`.
2. Define a GATT service (Sensor Board) to hold the values from peripherals for a read access from a GATT client.
3. Similarly, when a GATT client writes a value to a GATT server characteristic in a peripheral (GAP), there must be a method for the peripheral (GAP) to write the value destined for characteristic into the peripheral port.
4. A GATT client on a Central (GAP) device is used to access the GATT characteristics in the peripheral (GAP) which is an RN4870 with Sensor Board. The GATT client for the Sensor Board is a smartphone app named BLESensorApp. It is possible to use another RN4870 as the GATT client to access the RN4870 Sensor Board peripherals.

The critical function of associating GATT characteristic with a peripheral is performed by the RN4870 scripting capability. The RN4870 can be manually configured by following the instructions in [Section 4.2 “Connecting The BM-70-CDB To A Host PC”](#) through [Section 4.5 “Creating Custom GATT Services”](#). Alternatively, the RN4870 can also be configured by using the PC Utility (`RN4870_SensorBoard_Cfg_Cmd.exe`) as described in [Section 5.7 “Provision Utility”](#).

5.2 READING SENSOR BOARD PERIPHERAL I/O PORTS USING UART COMMANDS

The RN4870 has digital and analog peripheral inputs and outputs. For a detailed description of the I/O interface, refer to the “*RN4870/71 Bluetooth® 4.2 Low Energy Module Data Sheet*” (DS50002489), and for the configuration details, refer to Section 2.4.24 and Section 2.6.5 through Section 2.6.8 of the “*RN4870/71 Bluetooth® Low Energy Module User's Guide*” (DS50002466). Peripheral I/O can be accessed through direct UART commands or over Bluetooth Low Energy connection by associating a GATT characteristic with a peripheral input or output.

This section provides the procedure on how to read and write peripherals on the Sensor Board using the BM70 and the terminal emulator. The pins on the BM70 of the BM-70-CDB that are connected to the corresponding peripherals on the Sensor Board are indicated in [Figure 5-1](#).

1. Connect the Sensor Board to the BM-70-CDB as shown in [Figure 1-1](#).
2. Set the module to Factory default using the `SF, 1` command to set the peripherals to default.
 - Using Terminal Emulator, open the COM port to the RN4870 module.
 - Type `$$$` to enter Command mode.
 - Enter `SF, 1` and verify that the module reboots after entering the command.

BM70 Compact Demo Board (CDB) User's Guide

3. Enter the following sequence of commands to configure the RN4870 I/O pins as illustrated in [Figure 5-1](#):
 - Type \$\$\$ to enter Command mode.
 - Enter + to enable local echo.
 - Enter `SW,01,00` for ADC input port 01 used by the light sensor.
 - Enter `SW,02,00` for ADC input port 02 used by the potentiometer.
 - Enter `SW,03,00` to configure digital I/O port connected to the LED.
 - Enter `SW,04,09` to configure digital I/O trigger connected to the push button.
 - Enter `R,1` to reboot the module for the settings to take effect.

FIGURE 5-1: RN4870 PINS USED BY SENSOR BOARD INTERFACE

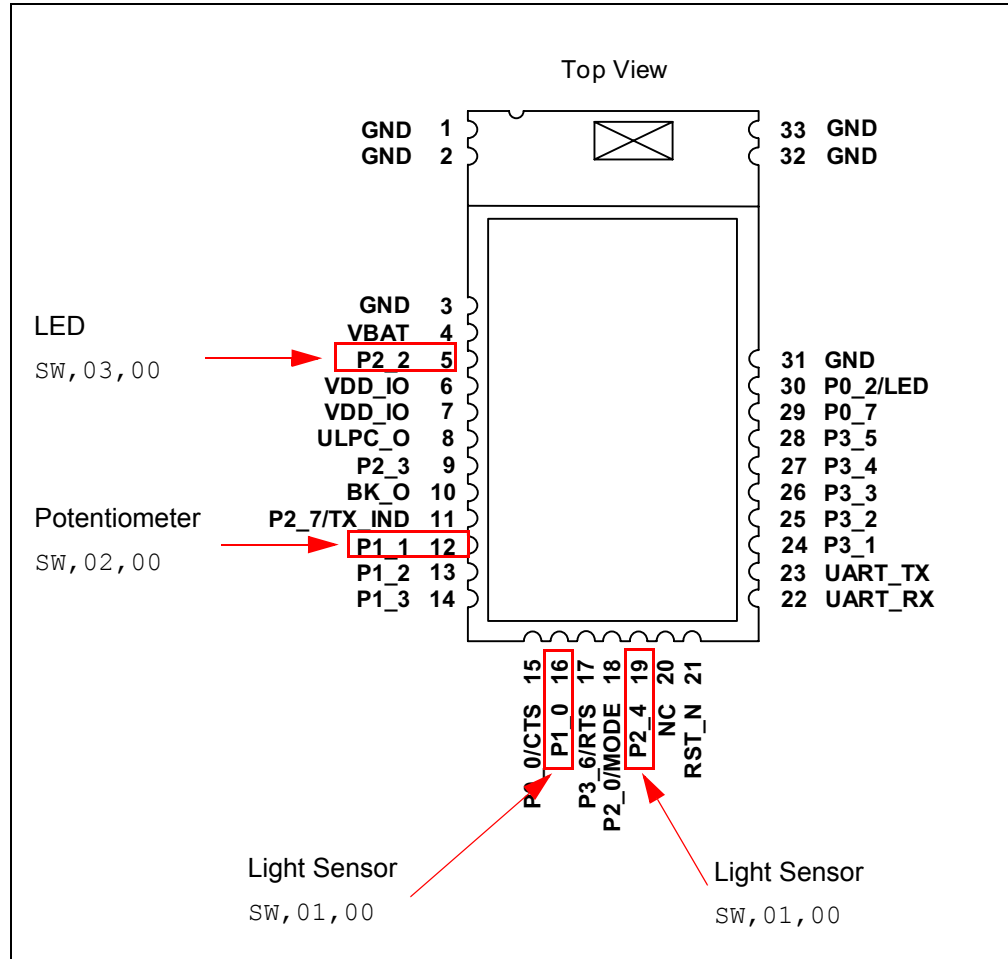

4. After the I/O ports are configured and the module is rebooted, enter the commands shown in [Figure 5-2](#) to read and write peripheral I/O.

FIGURE 5-2: COMMANDS TO READ AND WRITE SENSOR BOARD I/O

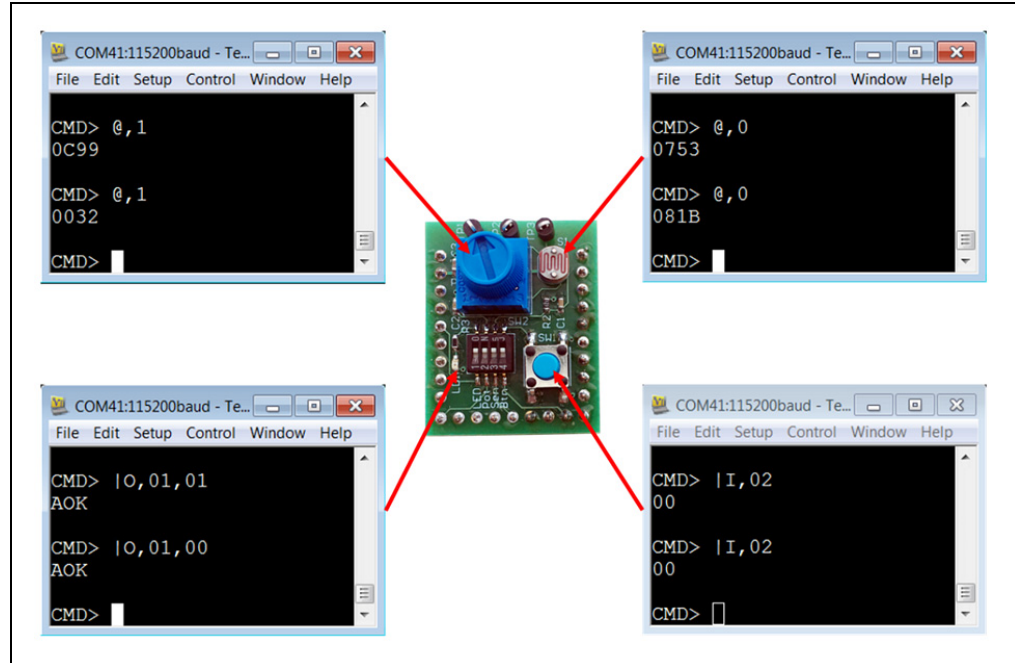

5.3 CONFIGURING THE RN4870 MODULE SETTINGS

The RN4870 and the Sensor Board can be configured by entering the commands manually. Alternatively, the configuration commands are located in [Appendix F. “Sensor Board Script Text”](#). Each command can be copied to the clipboard via <CTRL+C> and sent to the RN4870 via TeraTerm using the <ALT+R> (Paste) command.

1. Connect the BM-70-CDB to the host PC USB port.
 - Using Terminal Emulator, open the COM port to the RN4870.
 - Type \$\$\$ to enter Command mode.
 - Enter + to turn ON local echo.
 - Enter WP to stop any running script.
 - Enter WC to clear any previous script.
 - Enter PZ to clear any previous user defined GATT service.
 - Enter SF, 1 to set the module into factory default and verify that the module reboots after the command is entered.
 - Type \$\$\$ to re-enter Command mode.
 - Enter + to turn ON local echo.
2. Configure Module Features.
 - Enter S-, RN4870 to serialize Bluetooth name.
 - Enter SS, 80 to enable Device Information Profile.
 - Enter SR, 4040 to enable scripting start on PWR_ON event and disable command prompt.
 - Enter SW, 01, 00 for ADC input port 01 used by the light sensor.
 - Enter SW, 02, 00 for ADC input port 02 used by the potentiometer.
 - Enter SW, 03, 00 to configure digital I/O port connected to the LED.
 - Enter SW, 04, 09 to configure digital I/O trigger connected to the push button.
 - Enter R, 1 to reboot the module.
 - Type \$\$\$ to re-enter Command mode.

BM70 Compact Demo Board (CDB) User's Guide

- Enter + to turn ON local echo.
- Enter command D to display settings as shown in [Figure 5-3](#). Command GW is used to return to the current I/O configuration.

FIGURE 5-3: RN4870 MODULE SETTINGS CONFIGURATION

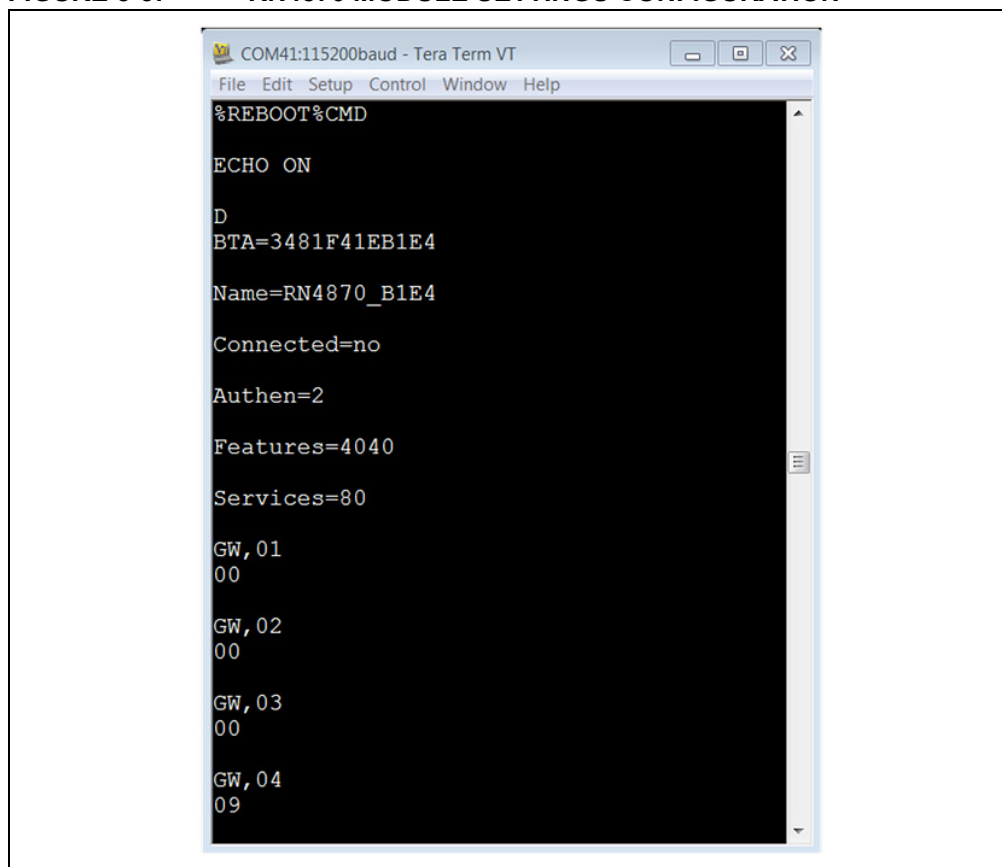

```
COM41:115200baud - Tera Term VT
File Edit Setup Control Window Help
%REBOOT%CMD
ECHO ON
D
BTA=3481F41EB1E4
Name=RN4870_B1E4
Connected=no
Authen=2
Features=4040
Services=80
GW, 01
00
GW, 02
00
GW, 03
00
GW, 04
09
```

5.4 SENSOR BOARD GATT SERVICE

The data from the RN4870 peripheral I/O are stored in the characteristics of a custom GATT service accessed by the Sensor Board BLE Client App. To create the Sensor Board GATT Service and characteristics, enter the following commands while in Command mode:

1. `PS,AD11CF40063F11E59E690002A5D5C51B` to create a 128-bit UUID to identify the GATT Service.
2. `PC,BF3FBD80063F11E59E690002A5D5C501,10,02` to declare a two-byte characteristic with notify property enabled. This characteristic stores the value of the ADC channel used for light sensor.
3. `PC,BF3FBD80063F11E59E690002A5D5C502,10,02` to declare a two-byte characteristic with notify property enabled. This characteristic stores the value of the ADC channel used for potentiometer.
4. `PC,BF3FBD80063F11E59E690002A5D5C503,18,14` to declare a 20-byte characteristic used to manage both the push button state (virtual LED in App) and the LED blink rate on the Sensor Board. Both notify and write properties are enabled for this characteristic.

5. PC, BF3FBD80063F11E59E690002A5D5C504, 10, 02 to declare a two-byte characteristic with notify property enabled. This characteristic stores the value of the ADC channel used for the RN4870 internal temperature sensor.
6. PC, BF3FBD80063F11E59E690002A5D5C505, 10, 02 to declare a two-byte characteristic with notify property enabled. This characteristic stores the value of the ADC channel used for the RN4870 internal battery voltage sensor.
7. Command R, 1 to reboot the RN4870 module.
8. Command \$\$\$ to enter Command mode.
9. Command + to enable local echo.
10. Command LS (list services) to display Sensor Board GATT Service as shown in [Figure 5-4](#).

FIGURE 5-4: SENSOR BOARD GATT SERVICE DECLARED IN RN4870

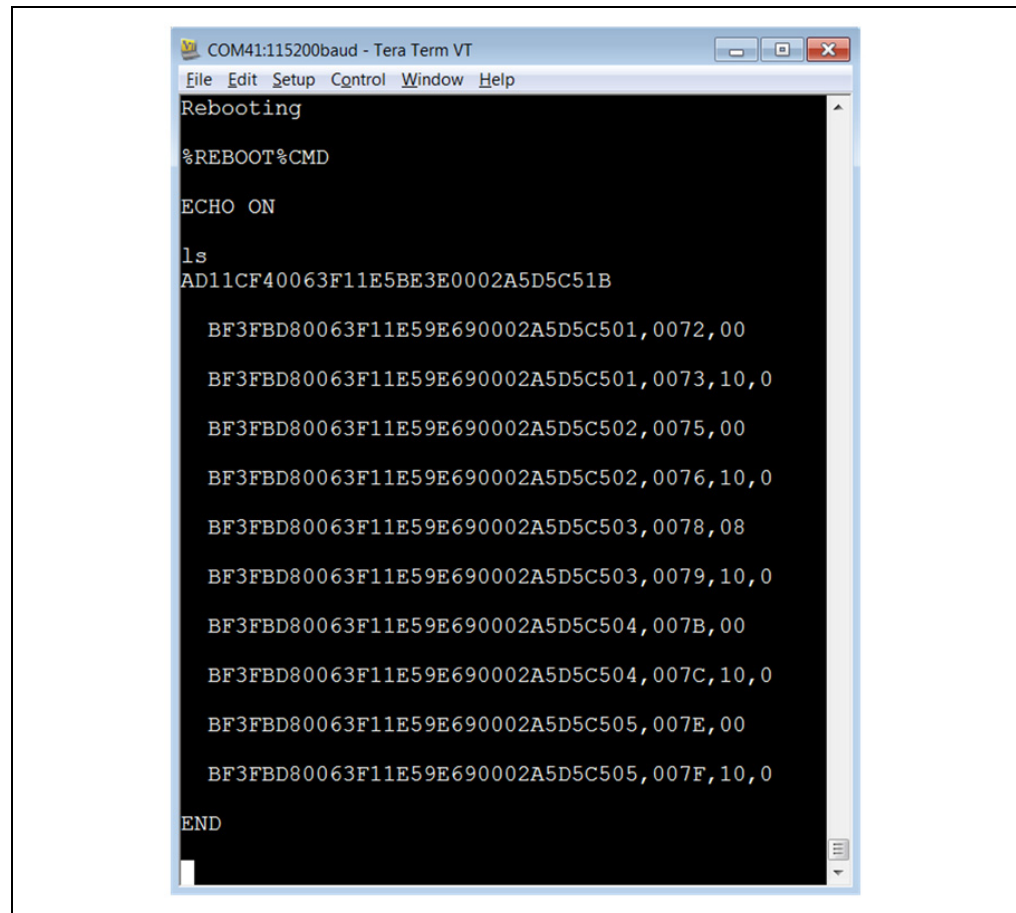

```
COM41:115200baud - Tera Term VT
File Edit Setup Control Window Help
Rebooting
%REBOOT%CMD
ECHO ON
ls
AD11CF40063F11E5BE3E0002A5D5C51B

BF3FBD80063F11E59E690002A5D5C501, 0072, 00
BF3FBD80063F11E59E690002A5D5C501, 0073, 10, 0
BF3FBD80063F11E59E690002A5D5C502, 0075, 00
BF3FBD80063F11E59E690002A5D5C502, 0076, 10, 0
BF3FBD80063F11E59E690002A5D5C503, 0078, 08
BF3FBD80063F11E59E690002A5D5C503, 0079, 10, 0
BF3FBD80063F11E59E690002A5D5C504, 007B, 00
BF3FBD80063F11E59E690002A5D5C504, 007C, 10, 0
BF3FBD80063F11E59E690002A5D5C505, 007E, 00
BF3FBD80063F11E59E690002A5D5C505, 007F, 10, 0
END
```

[Figure 5-4](#) illustrates that a custom GATT service has been created in the RN4870. A 16-bit handle is assigned to each characteristic where each characteristic has a value handle and a property handle. The characteristic value and the properties are accessed by a short and more efficient 16-bit handle instead of the 128-bit UUID value. For example, two handles 0072 and 0073 are associated with the GATT characteristic BF3FBD80063F11E59E690002A5D5C501. A GATT client such as a smartphone App uses 0072 to read/write characteristic values, whereas 0073 is used to enable or disable the notify property.

The next step is to transfer the sensor values from the peripheral I/O into the GATT characteristics. This is done with the RN4870 scripting feature as described in [Section 5.5 “Transferring Sensor Data Into GATT Service Using Scripting”](#).

BM70 Compact Demo Board (CDB) User's Guide

5.5 TRANSFERRING SENSOR DATA INTO GATT SERVICE USING SCRIPTING

For more information about the Sensor Board GATT service, refer to [Section 5.4 “Sensor Board GATT Service”](#). To populate the characteristics with data from the Sensor Board peripherals, and conversely transfer values received from the GAP client into peripheral I/O channels, the RN4870 scripting feature is used. For more details on the scripting capabilities, refer to the “*RN4870/71 Bluetooth® Low Energy Module User's Guide*” (DS50002466).

The script that drives peripheral values to and from the GATT service is written into the Nonvolatile Memory (NVM) of the RN4870 via the UART.

First, put the module into Script Entry mode. The script is a series of text commands separated by carriage returns. The actual script is displayed in [Appendix F. “Sensor Board Script Text”](#). It can be copied to the clipboard and pasted in UART using TeraTerm. Similarly, the PC Utility can load it into RN4870.

To manually load the Sensor Board script, perform the following steps:

1. Connect the BM-70-CDB to the host PC USB port.
 - Using Terminal Emulator, open the COM port to the RN4870 module.
 - Type \$\$\$ to enter Command mode.
 - Enter + to turn ON ECHO.
2. Enter Script Entry mode.
 - Enter command ww to put the RN4870 into Script Entry mode. This command does not return an AOK response.
 - Copy the script text from [Appendix F. “Sensor Board Script Text”](#) into the clipboard using <Ctrl+C>.
 - Enter the script in TeraTerm using the <Alt+R> (Paste) command.

[Figure 5-5](#) shows a dialog window showing the script text from the clipboard.

FIGURE 5-5: SENSOR BOARD SCRIPT DISPLAYED FROM CLIPBOARD

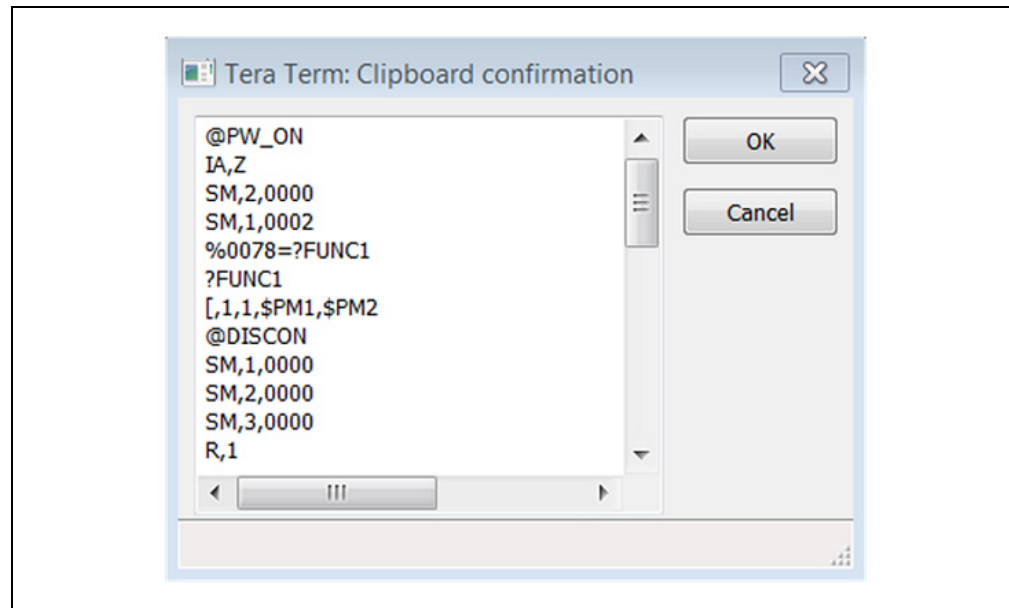

- Press **OK** to load the script into the RN4870.
- After the script is entered into the RN4870, exit Script Entry mode by pressing the <ESC> key. An AOK response is sent to the terminal. The script entry is shown in [Figure 5-6](#).

FIGURE 5-6: COMPLETED SENSOR BOARD SCRIPT

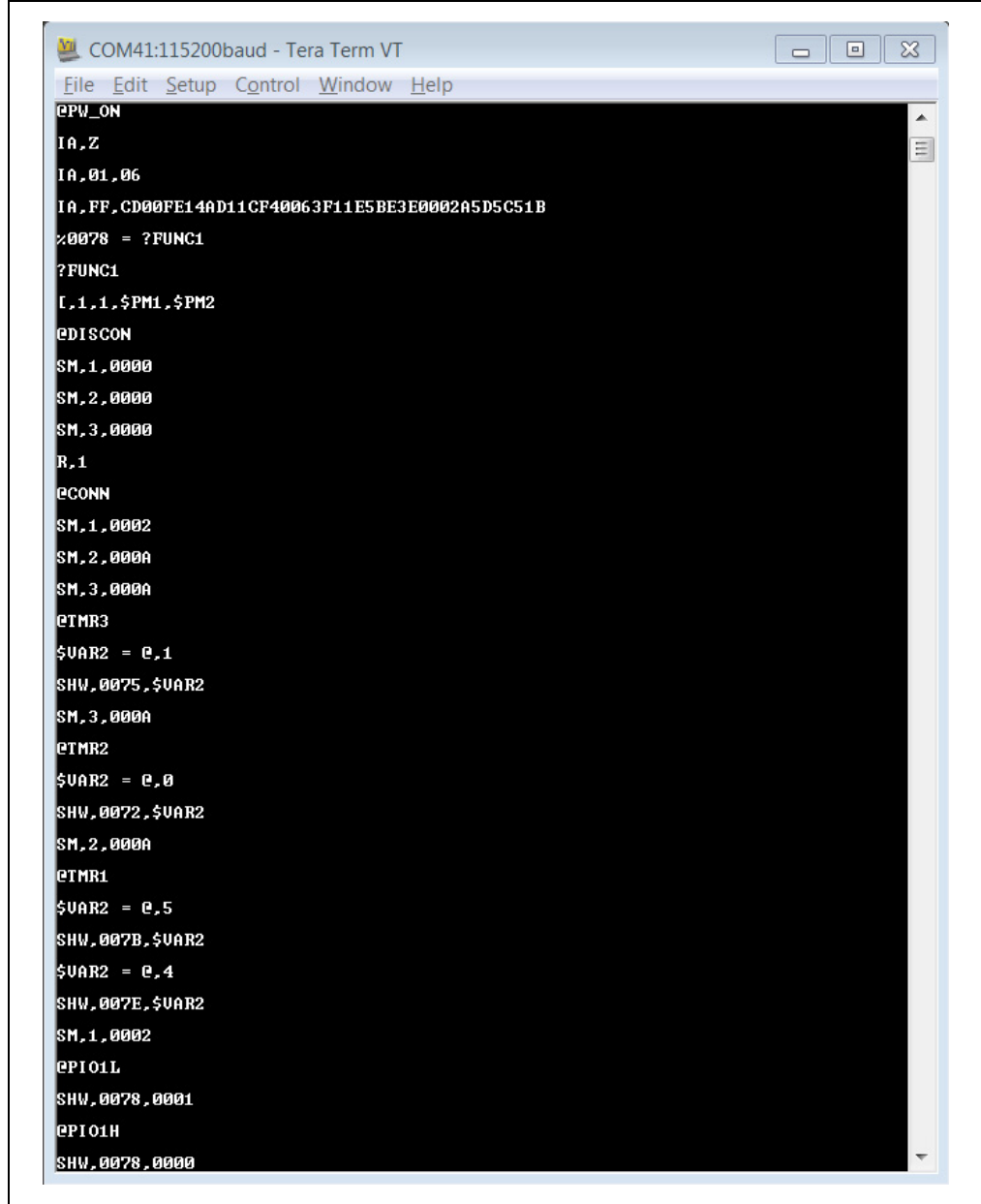

```
COM41:115200baud - Tera Term VT
File Edit Setup Control Window Help
@PW_ON
IA,Z
IA,01,06
IA,FF,CD00FE14AD11CF40063F11E5BE3E0002A5D5C51B
%0078 = ?FUNC1
?FUNC1
I,1,1,$PM1,$PM2
@DISCON
SM,1,0000
SM,2,0000
SM,3,0000
R,1
@CONN
SM,1,0002
SM,2,000A
SM,3,000A
@TMR3
$VAR2 = e,1
SHW,0075,$VAR2
SM,3,000A
@TMR2
$VAR2 = e,0
SHW,0072,$VAR2
SM,2,000A
@TMR1
$VAR2 = e,5
SHW,007B,$VAR2
$VAR2 = e,4
SHW,007E,$VAR2
SM,1,0002
@PIO1L
SHW,0078,0001
@PIO1H
SHW,0078,0000
```

- Enter command `R, 1` to reboot the RN4870. After reboot, the Sensor Board is ready to use. [Figure 5-7](#) shows the script event handlers are seen on the TeraTerm display.

BM70 Compact Demo Board (CDB) User's Guide

FIGURE 5-7: SCRIPT EVENT HANDLERS

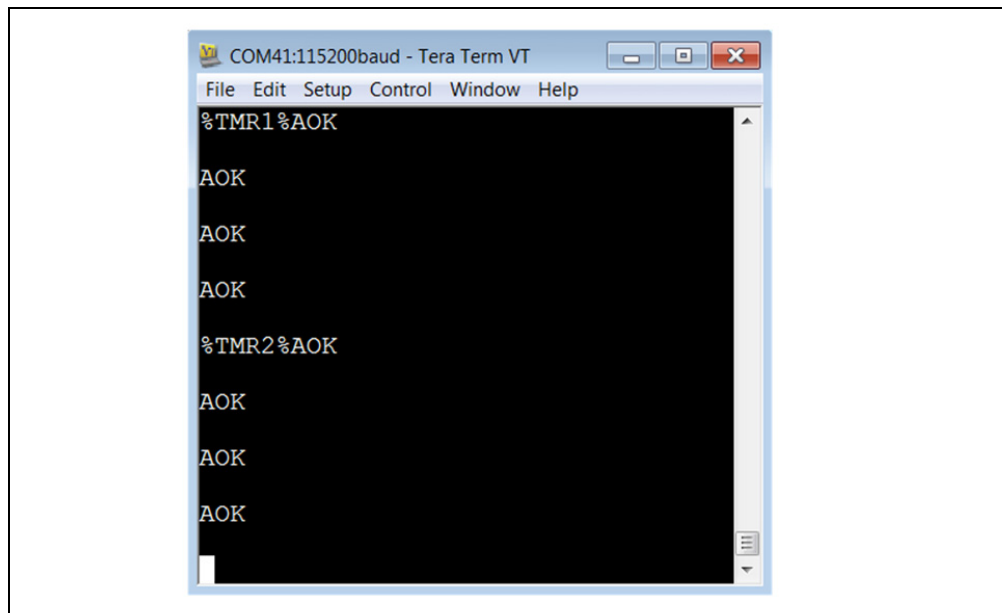

5.6 BLESENSORAPP SMARTPHONE APP

The RN4870 Sensor Board is a BLE Peripheral that advertises a GATT service to BLE Central devices. In this demonstration, the BLE Central device is a smartphone application named BLESensorApp. It is available to download for iOS and Android platforms via iTunes App Store, and Google Play Store, respectively. Search for the “Microchip BLESensorApp”, and download the App matching the icon in [Figure 5-8](#).

FIGURE 5-8: BLESENSORAPP ICON

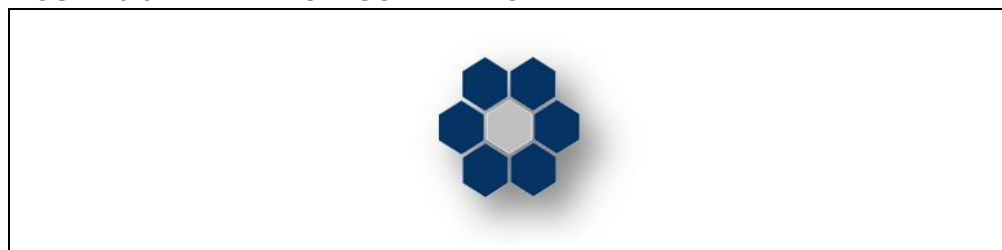

The BLESensorApp requires the Sensor Board to be configured as described in [Section 5.3 “Configuring The RN4870 Module Settings”](#), [Section 5.4 “Sensor Board GATT Service”](#), and [Section 5.5 “Transferring Sensor Data Into GATT Service Using Scripting”](#).

1. Ensure that the Sensor Board is attached to the BM-70-CDB. Refer to [Figure 1-1](#).
2. Verify the Switch 2 in SW2 is in position 2: application mode.
3. Power the BM-70-CDB via USB
 - Connect the BM-70-CDB to power up
 - Verify that LD2 blinks blue with long interval.
4. Launch the BLESensorApp from the smartphone. In this example, the iOS version is used as shown in [Figure 5-9](#).
5. The BLESensorApp attempts to connect to the first RN4870 Sensor Board it discovers. Once connected, the main user interface of the BLESensorApp is displayed. This auto connection is only possible when location access permission is enabled for BLESensorApp.

FIGURE 5-9: BLESENSORAPP



6. If location access permission is not enabled, then BLESensorApp displays the list of available RN4870 Sensor Boards in the vicinity. The connection can be initiated by clicking the desired device as shown in [Figure 5-9](#).

BM70 Compact Demo Board (CDB) User's Guide

FIGURE 5-10: BLE DATA FLOW FROM SENSOR BOARD PERIPHERAL I/O TO BLESENSORAPP

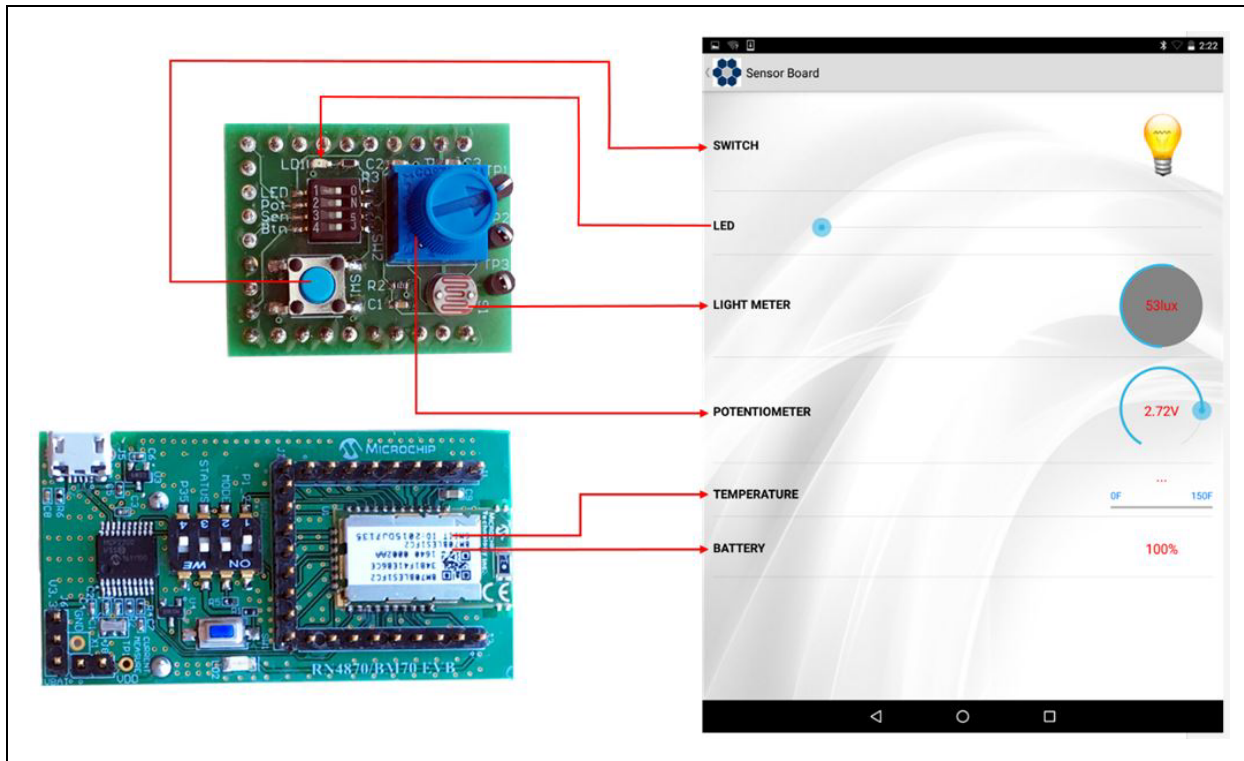

Figure 5-10 illustrates the data flow between the RN4870 Sensor Peripheral I/O and the smartphone app. The data streaming from the Sensor Board to the App is performed by GATT Notifications. The script polls the sensor values, such as Switch, Light Meter, and writes the values into the appropriate GATT Characteristic. If the value changes, a GATT Notification is sent to the BLESensorApp where the App updates the Graphical User Interface (GUI).

BLE data can also be transferred from the BLESensorApp to the RN4870, and later processed by the script to write a received value into the Peripheral output channel. In the Sensor Board demo, slider control is used on the App to select a blink rate value. The value is written to GATT characteristic in the RN4870. The sensor script monitors the Characteristic for incoming data then extracts the value which is subsequently written to the Pulse-With Modulation (PWM) output peripheral to control LED blink rate.

For more information on the BLE GATT data transfers, refer to [Appendix E. “Bluetooth Low Energy Primer”](#).

5.7 PROVISION UTILITY

The RN4870 Provision Utility can be used to provision or configure the RN4870 Bluetooth Low Energy (BLE) module from a Windows Host PC using a wired connection over UART interface. The RN4870 Provision Utility is used to program the RN4870 with the configuration and script to work with the Sensor Board and the BLESensorAPP.

The utility comes with a few prebuilt provision options that can be selected using the Provision File drop-down menu. Alternatively, a custom configuration XML file can be imported into the utility to provision the RN4870 module.

Detailed instructions for provisioning the RN4870 module and creating custom configuration XML file are provided in the RN4870 Provision Utility Help files. Examples of the Provision XML file are in the Examples folder.

Download the RN4870 Provision Utility from www.microchip.com/RN4870. Extract the contents into a separate folder on the host PC. The contents of the extracted folder include the RN4870 Provision Utility executable, the RN4870 Provision Utility Help files and the example configuration XML files. This utility requires the MCP2200 USB/UART CDC drivers. The driver is also available from the web page. Install the driver if needed.

Note: While the provisioning is in progress, the RN4870 must not be disconnected and the process must not be interrupted. If the provisioning process is interrupted, the RN4870 module may not be configured as desired.

To configure the RN4870 with a Sensor Board plugged in, perform the following steps:

1. Ensure that the Sensor Board is attached to the RN4870 (BM-70-CDB). Refer to [Figure 1-1](#).
2. Verify the Switch 2 in SW2 is in position 2: application mode.
3. Connect the RN4870 to the host PC using the Micro-USB cable and verify that the LD2 blinks blue with long interval.
4. Wait for the RN4870 board to successfully enumerate as a Serial Port device.
5. After the RN4870 board enumerates as a Serial Port device, open the Device Manager on the Windows PC and note down the COM port number assigned to the RN4870 board under 'Ports'.
6. Run the RN4870 Provision Utility (`RN4870ProvisionUtility.exe`) on the Windows PC. Refer to [Figure 5-11](#).

FIGURE 5-11: CONFIGURATION UTILITY MAIN WINDOW

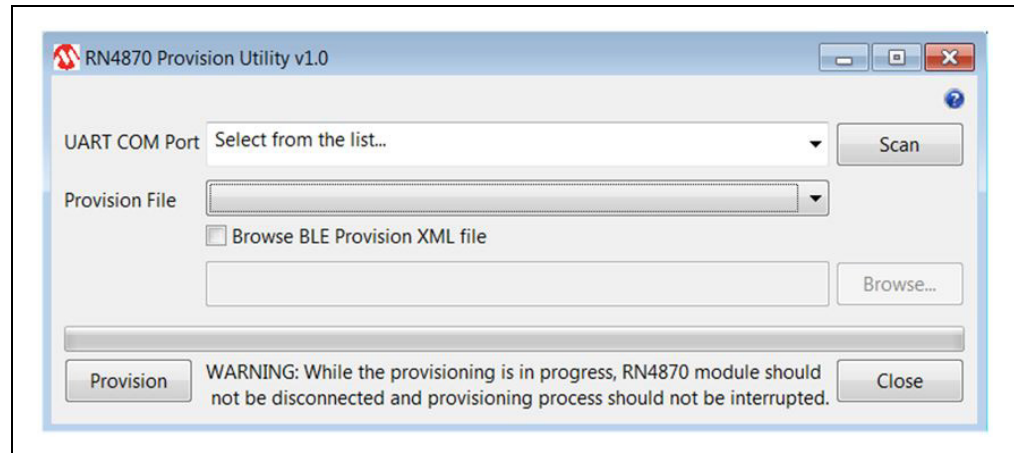

7. Ensure that the RN4870 board is still connected to the Windows PC and successfully enumerated. Click **Scan** button to scan for all the UART COM ports available on the Windows PC.

Note: Ensure that the COM port on which the RN4870 board is enumerated is not opened by another application like a Serial Terminal application.

8. Click the drop-down menu of the UART COM Port and select the correct COM port that is assigned to the RN4870 board to be provisioned. Refer to [Figure 5-12](#).

BM70 Compact Demo Board (CDB) User's Guide

FIGURE 5-12: CONFIGURATION UTILITY: SELECT COM PORT

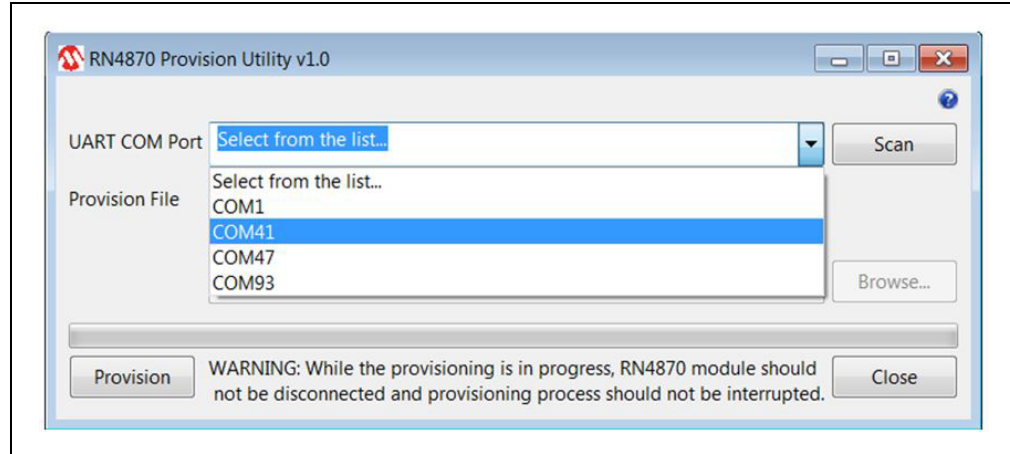

9. A set of prebuilt provision options for the RN4870 module are provided. Choose the `RN4870_Sensors_Demo_1.xml` XML file from the Provision File drop-down menu as shown in [Figure 5-13](#).

Note: Use only a valid BLE Provision XML (.xml) file.

FIGURE 5-13: CONFIGURATION UTILITY: SELECT XML FILE

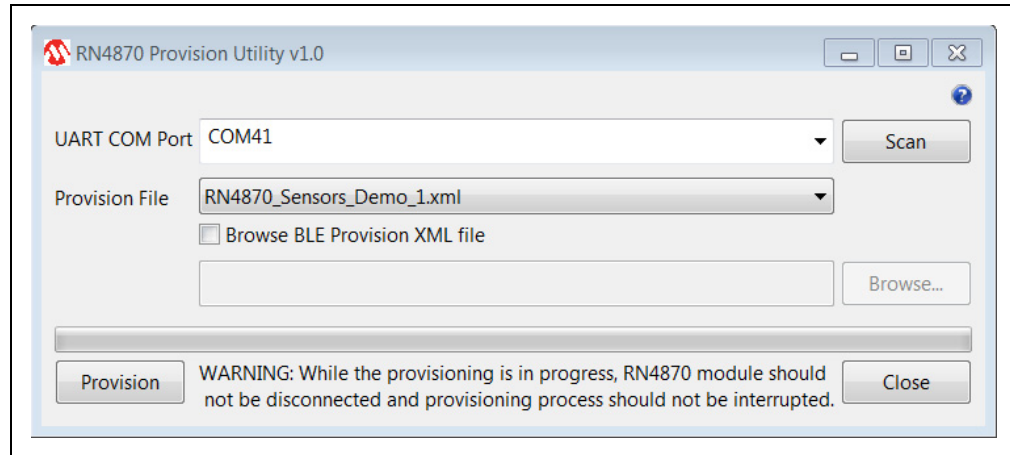

10. With the RN4870 board still connected, the COM port and the `RN4870_Sensors_Demo_1.xml` file selected, click **Provision** button to start the RN4870 provisioning process. The progress bar shows the progress of the provisioning process. Refer to [Figure 5-14](#).

FIGURE 5-14: CONFIGURATION UTILITY: CONFIGURING MODULE

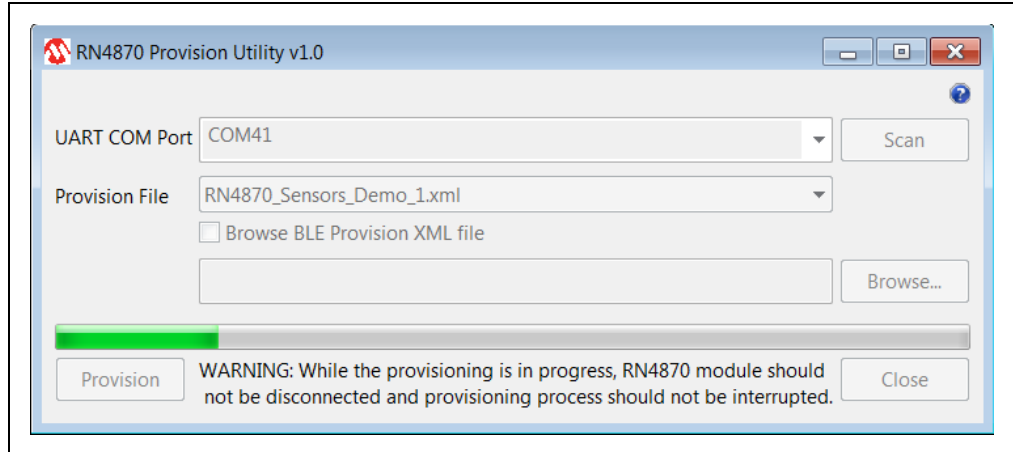

11. After the provisioning process is completed, an information dialog window pops up to inform about the successful provisioning of the RN4870 module. Refer to [Figure 5-15](#).

FIGURE 5-15: CONFIGURATION UTILITY: PROVISIONING SUCCESSFUL

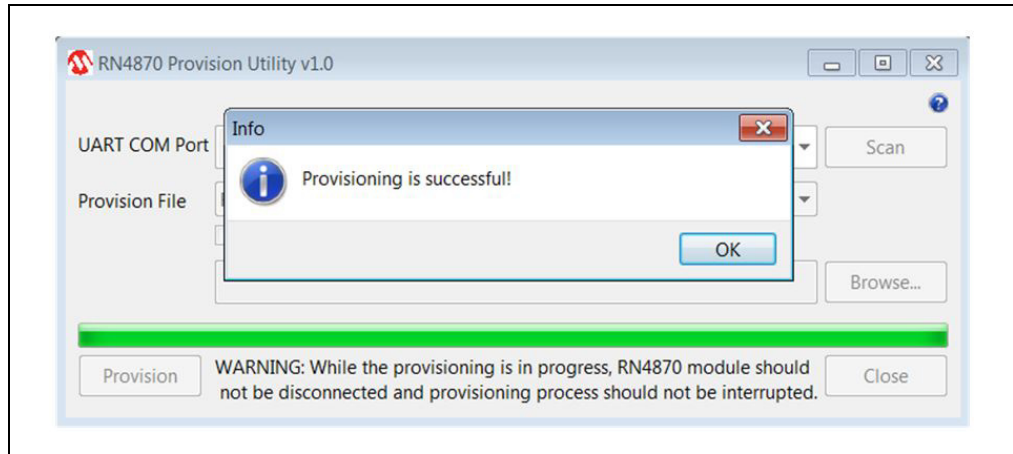

Note: After the provisioning is successful, the RN4870 automatically reboots and retains the provisioned configuration.

BM70 Compact Demo Board (CDB) User's Guide

NOTES:

Appendix A. Loading RN4870 Firmware

A.1 INTRODUCTION

The RN4870 firmware can be loaded into BM-70-CDB using a PC Tool `isupdate.exe` over the USB port. The latest RN4870 firmware images and the `isupdate.exe` tool are available from the product web page at www.microchip.com/RN4870.

To update the firmware on the BM-70-CDB, perform the following steps:

1. Download the firmware zip file from the product web page and extract the contents. The zip file contains the `isupdate.exe` utility and a folder including the firmware images.
2. Connect the BM-70-CDB to the host PC using the Micro-USB cable.
3. Verify that USB power is selected in J6 (close Pin 2 and Pin 3) and J8 (current measurement test point) is closed.
4. Verify that Switch 2 on SW2 is set to ON position.
5. Press **SW1** (Reset) button and verify that LD2 is showing a non-flashing blue that indicates the RN4870 is in programming mode.
6. Launch the `isupdate.exe` application.
 - Select the COM port used by the CDB.
 - Verify that other settings (baud rate, memory type, and address) are set as shown in [Figure A-1](#).

FIGURE A-1: ISUPDATE . EXE FIRMWARE UPDATE UTILITY

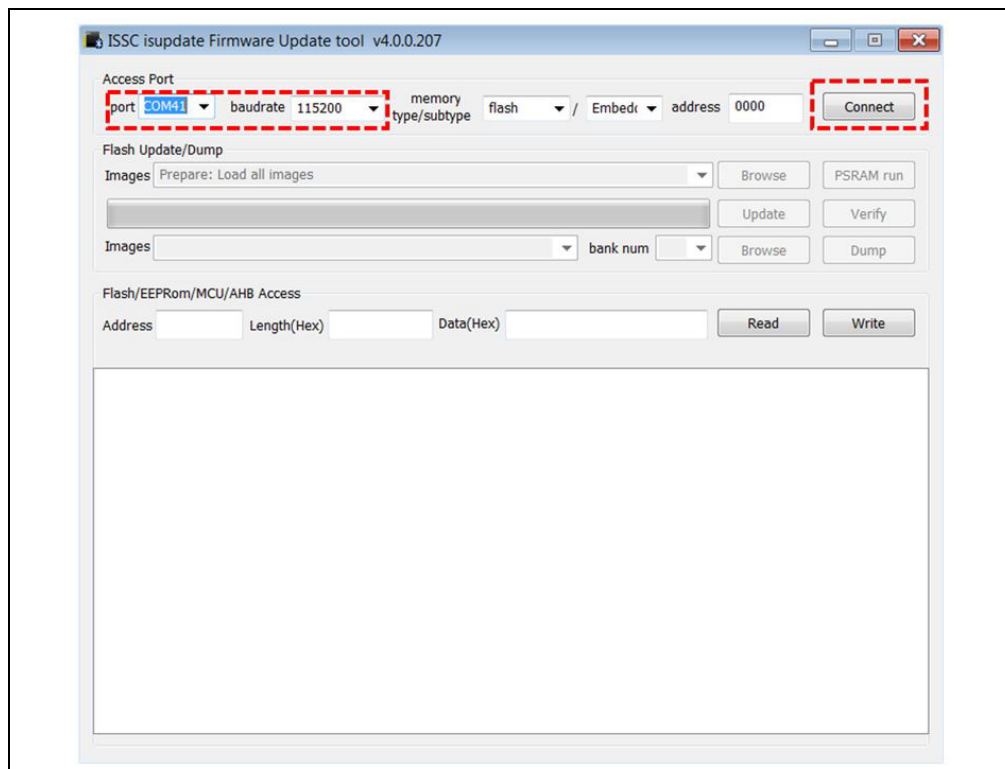

BM70 Compact Demo Board (CDB) User's Guide

7. Click the **Connect** button as shown in [Figure A-1](#).
8. Verify the "Port connect -> COMxx" is displayed in the text box, as shown in [Figure A-2](#).

FIGURE A-2: MODULE CONNECTED FROM ISUPDATE . EXE

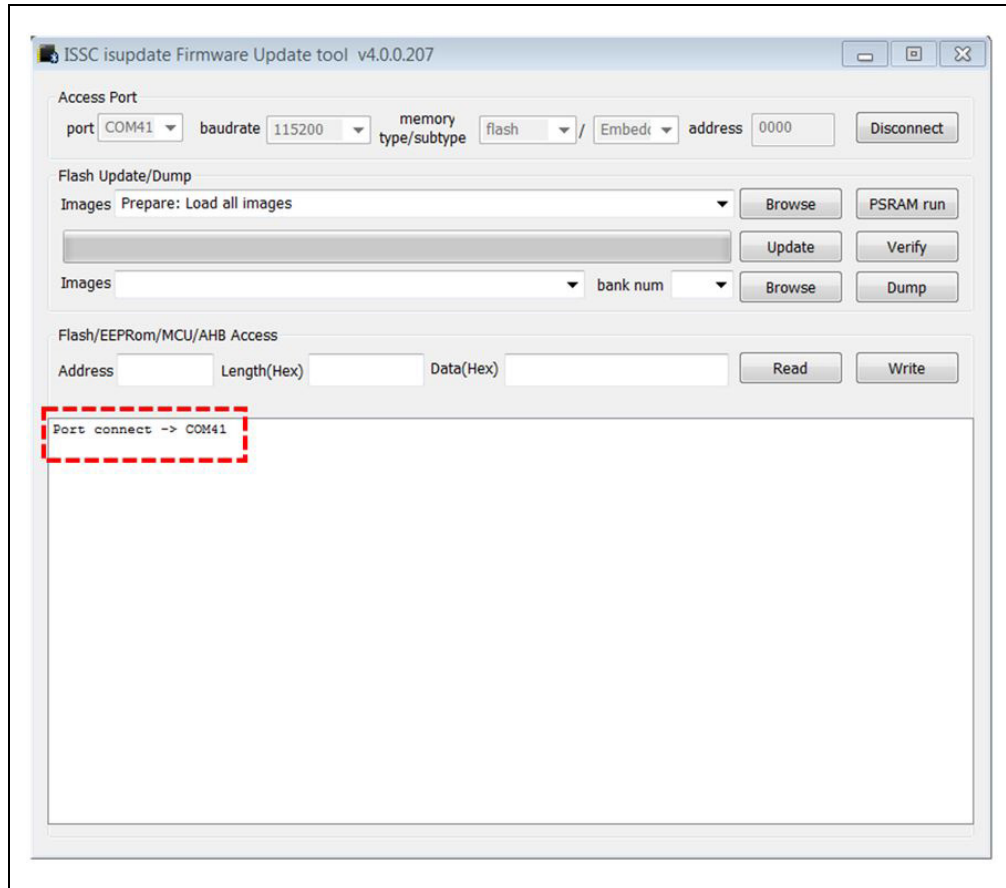

9. Click the **Browse** button to select the firmware files that must be flashed on the BM70 module.
10. Click the **Update** button to flash the selected image.

Loading RN4870 Firmware

11. Verify that the firmware update is successfully completed. The "End of Write Memory" message is displayed as shown in [Figure A-3](#).

FIGURE A-3: FIRMWARE SUCCESSFULLY UPDATED

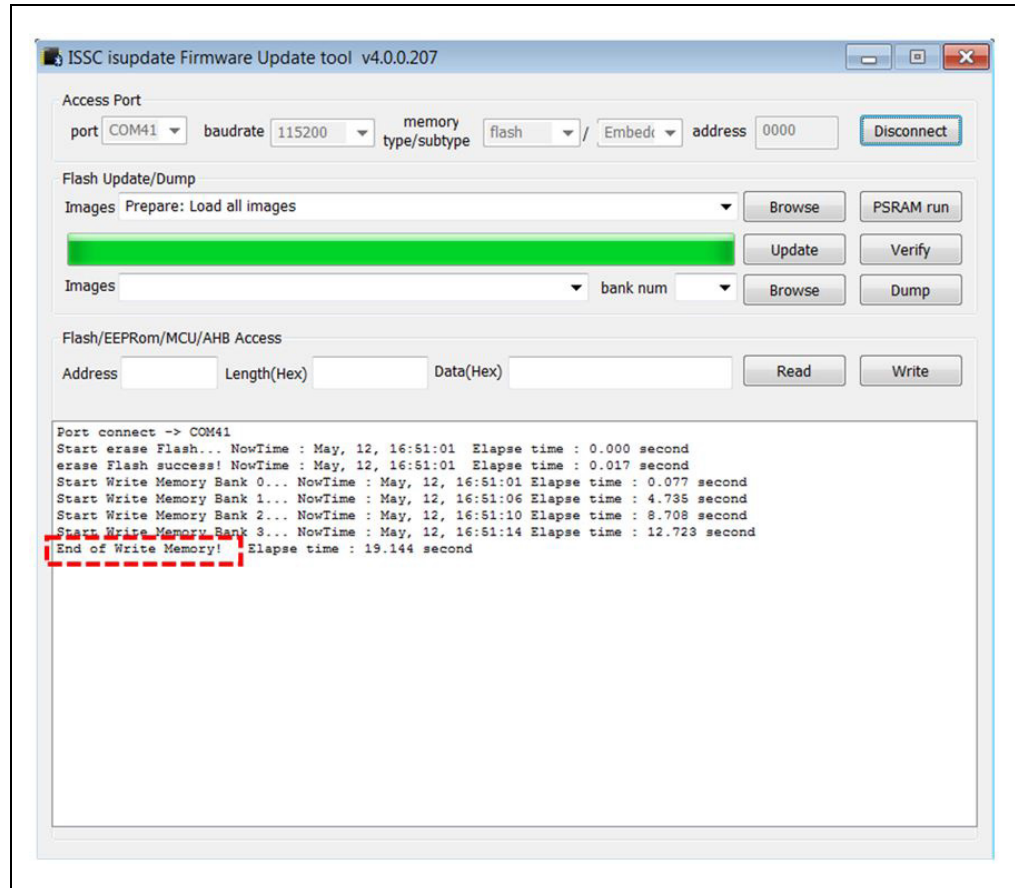

BM70 Compact Demo Board (CDB) User's Guide

- Click the **Disconnect** button to close the COM port. The "port disconnect" message is displayed as indicated in [Figure A-4](#).

FIGURE A-4: DISCONNECT ISUPDATE . EXE FROM THE MODULE

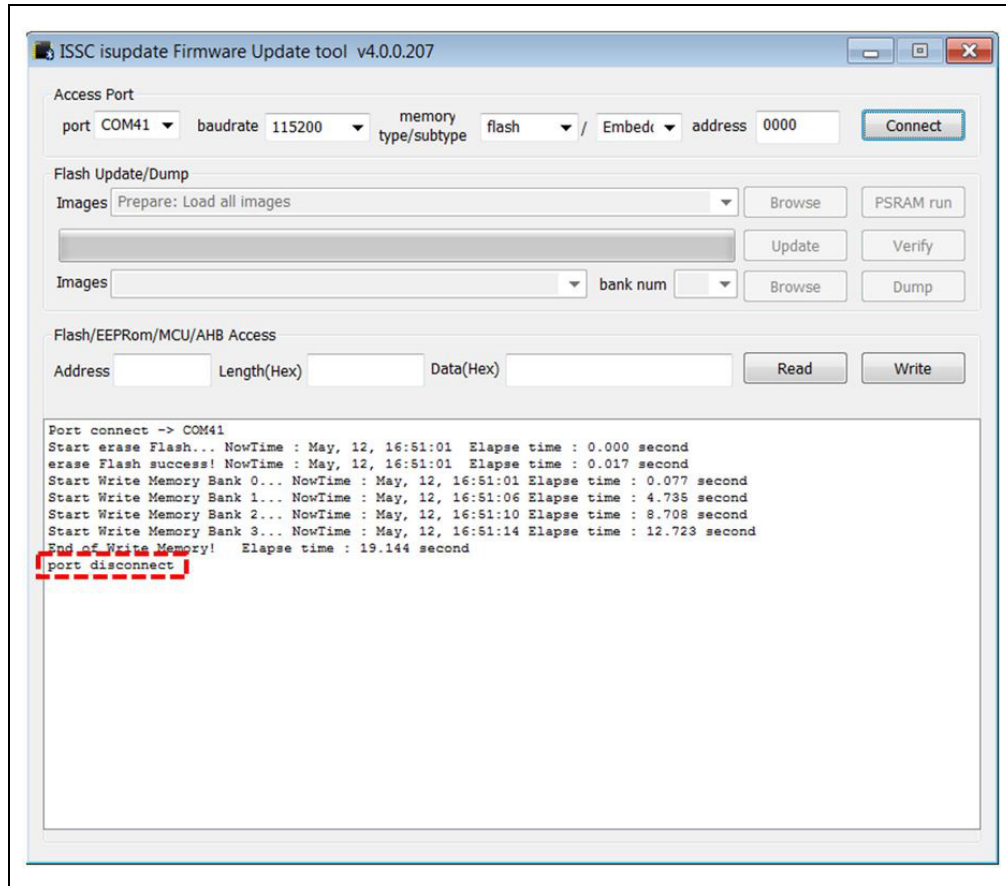

- Set Switch 2 on SW2 to position 2 for application mode.
- Open TeraTerm and connect to the module.
- Press SW1 to reboot the module. Ensure that the `%REBOOT%` message is displayed.
- Enter Command mode by sending `$$$` escape sequence.
- Enter the `v` command and verify firmware version as illustrated in [Figure A-5](#).

Note: While uploading the firmware on BM-70-CDB, ensure that the J6 jumper (Pin 2 and Pin 3) and J8 jumper (current measurement test point) are closed. Do not interrupt jumpers J6 and J8 during firmware update, otherwise the firmware can be corrupted.

FIGURE A-5: VERIFY FIRMWARE VERSION

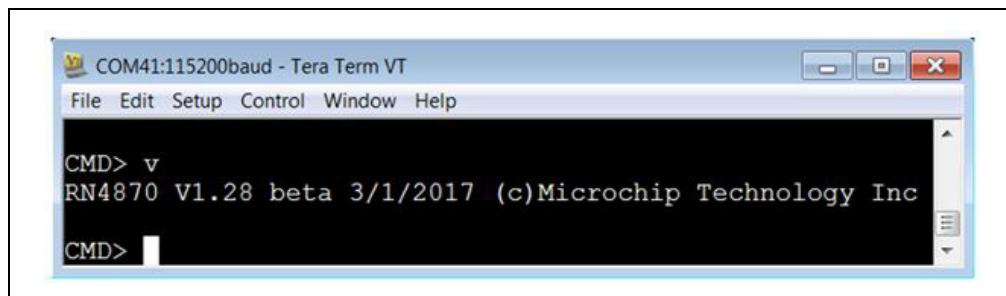

Appendix B. Loading BM70 Firmware

B.1 INTRODUCTION

The BM70 firmware can be updated using a PC Tool `isupdate.exe` over the USB port. The latest BM70 firmware images and the `isupdate.exe` tool are available from the Microchip product web page at www.microchip.com/BM70.

To update the firmware on the BM-70-CDB, perform the following steps:

1. Download the firmware zip file from the product web page and extract the contents. The zip file contains the `isupdate.exe` utility and a folder including the firmware images.
2. Connect the BM-70-CDB to the host PC using the Micro-USB cable.
3. Verify that USB power is selected in J6 (close Pin 2 and Pin 3) and J8 (current measurement test point) is closed.
4. Verify that Switch 2 on SW2 is set to ON position.
5. Press **SW1** (Reset) button and verify that LD2 is showing a non-flashing blue that indicates the BM70 is in programming mode.
6. Launch the `isupdate.exe` application.
 - Select the COM port used by the CDB.
 - Verify that other settings (baud rate, memory type, and address) are set as shown in [Figure B-1](#).

FIGURE B-1: ISUPDATE . EXE FIRMWARE UPDATE UTILITY

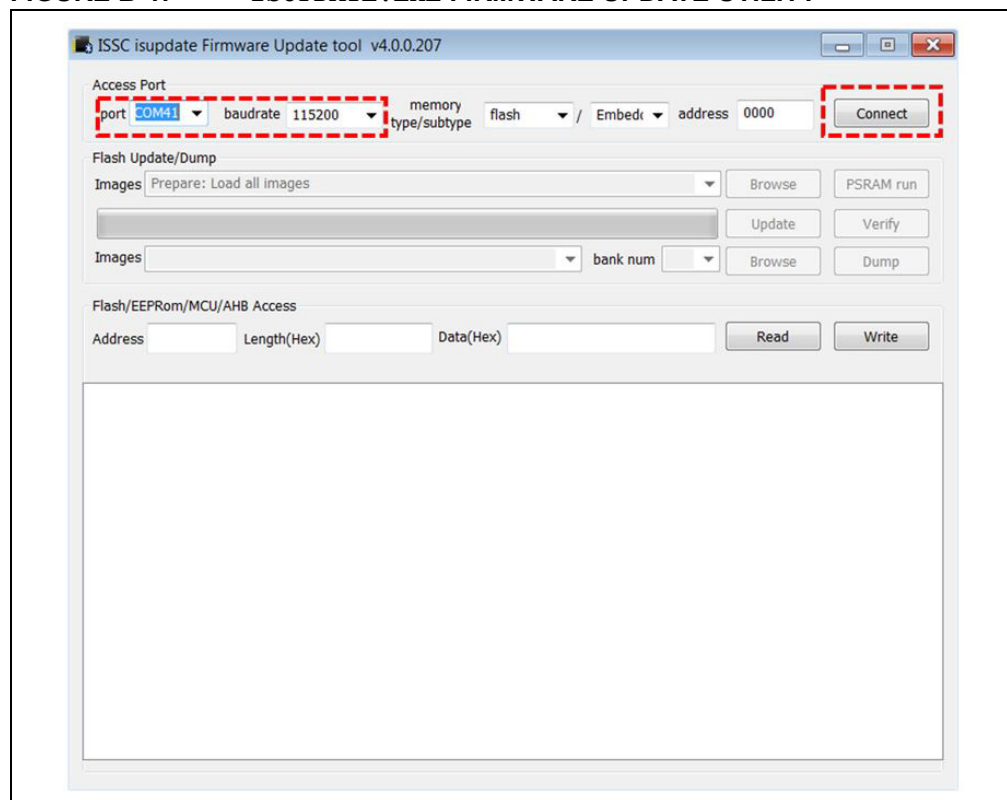

BM70 Compact Demo Board (CDB) User's Guide

7. Click the **Connect** button as shown in [Figure B-1](#).
8. Verify the "Port connect -> COMxx" is displayed in the text box as shown in [Figure B-2](#).

FIGURE B-2: MODULE CONNECTED FROM ISUPDATE . EXE

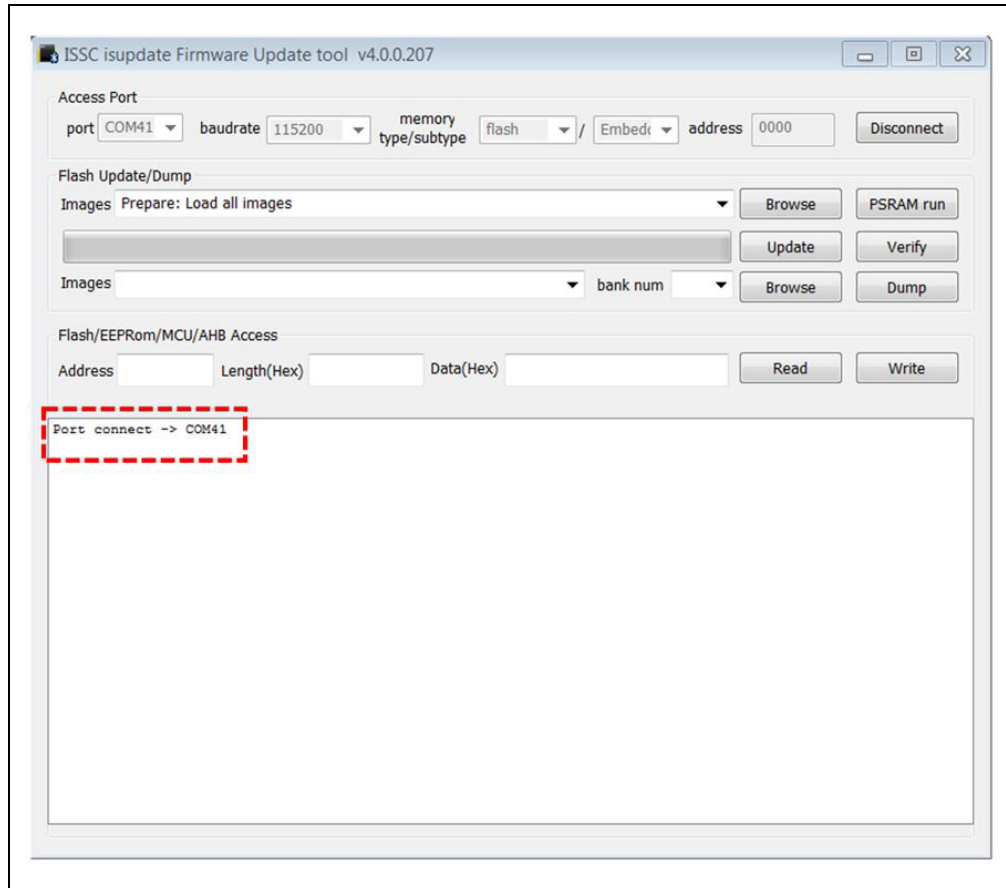

9. Click the **Browse** button to select the firmware files that must be flashed on the BM70 module.
10. Click the **Update** button to flash the selected image.
11. Verify that the firmware update is successfully completed. The "End of Write Memory" message is displayed as shown in [Figure B-3](#).

Loading BM70 Firmware

FIGURE B-3: MODULE CONNECTED FROM ISUPDATE . EXE

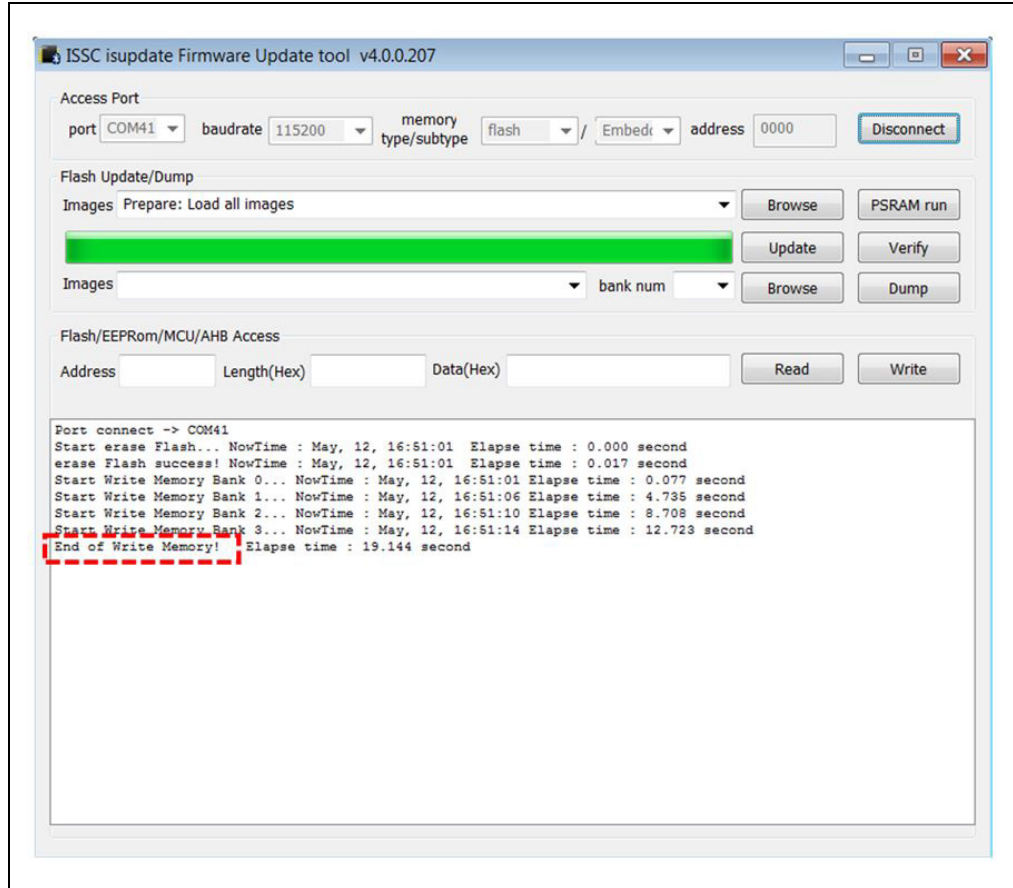

12. Click the **Disconnect** button to close the COM port. The "port disconnect" message is displayed as indicated in [Figure B-4](#).

BM70 Compact Demo Board (CDB) User's Guide

FIGURE B-4: DISCONNECT ISUPDATE . EXE FROM THE MODULE

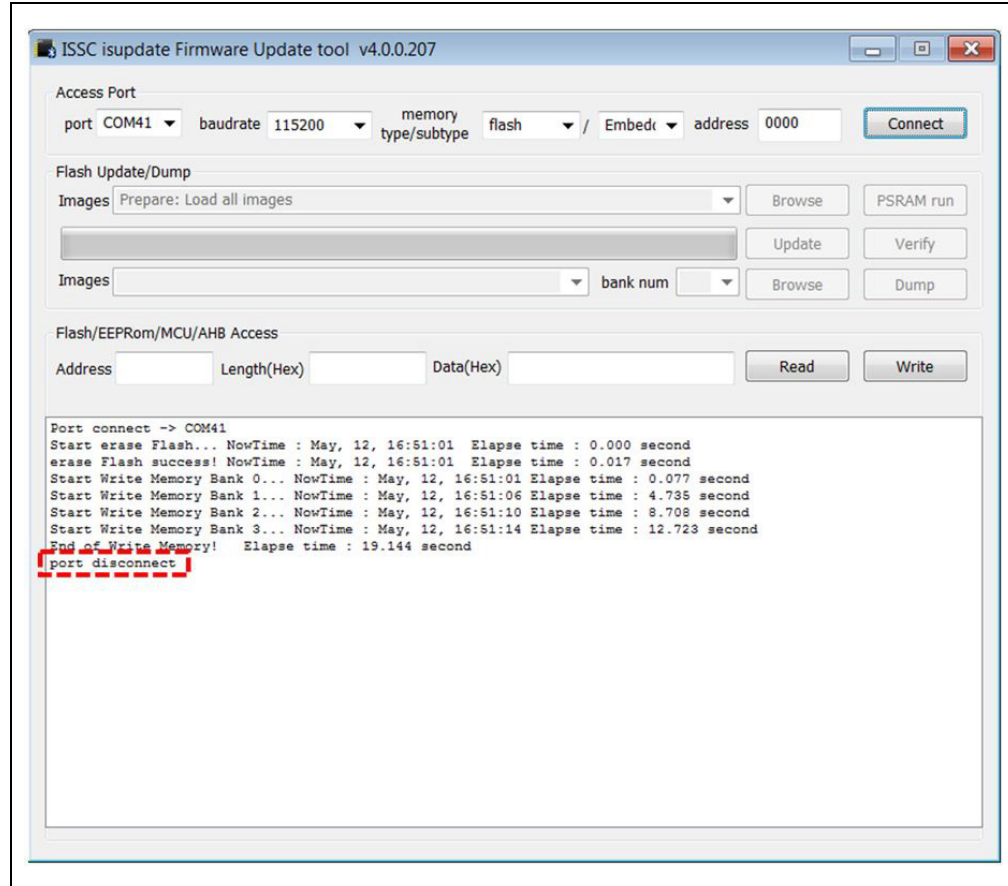

13. Set Switch 2 on SW2 to position 2 for application mode.
14. Press SW1 to reboot the module.

Note: While uploading the firmware on BM-70-CDB, ensure that the J6 jumper (Pin 1 and Pin3) and J8 jumper (current measurement test point) are closed. Do not interrupt jumpers J6 and J8 during firmware update, otherwise the firmware can be corrupted.

Appendix C. BM-70-CDB Example Configuration

C.1 INTRODUCTION

This appendix shows the procedure for updating the configuration parameters of the BM70 module using the BM-70-CDB.

C.2 REQUIREMENTS**C.2.1 Hardware Requirements**

- BM-70-CDB
- Bluetooth-enabled smartphone
 - iPhone 4S or later version (it must support BLE) or
 - Android device running Android 4.3 or later version
- Windows host PC with USB port
- Micro-USB cable

C.2.2 Software Requirements

Download and install the latest firmware and corresponding tools (Firmware_SoftwareTools_Vx_xx.zip) from the Microchip product web page at www.microchip.com/BM70.

- Firmware update tool (BM7xBLE_IS187x_FlashUpdateTool.exe)
- Firmware hex images (*.H00, *.H01, *.H02, *.H03)
- Configuration tool (IS187x_102_BLEDK3_UI v100.xxx.exe)

- Note 1:** Ensure that the latest firmware is downloaded to the IS1870 IC on the BM-70-CDB. Version 1.03 is the initial BLE firmware version programmed into BM70 modules in Microchip's manufacturing line at the time of releasing this product to market. The latest firmware is made available from the Microchip website at www.microchip.com/BM70.
- 2:** Ensure that the exact version of the Configuration tool (UI Tool) matches the specific firmware version programmed into the IS1870 IC's Flash memory is used to configure the module. For ease of use, the UI tool, firmware and firmware update utility are all provided in a single zip file for each version of firmware released by Microchip to the website. The latest firmware for the BM70 module is not compatible with older versions of the Configuration tool. To ensure that the correct version of firmware and tools are being used together, a Firmware_Software_Vx_xx.zip file is provided. This archive contains the firmware along with the compatible software tools for this specific firmware version.
- 3:** In the following example, the BM-70-CDB with firmware version 1.06 and Configuration tool (IS187x_102_BLEDK3_UI v100.132.exe) is used.

BM70 Compact Demo Board (CDB) User's Guide

C.3 SETTING CONFIGURATION PARAMETERS

The Configuration tool or User Interface (UI) tool is a PC-based program, which enables the user to change the configuration parameters of the BM70 (For hardware details on the configuration, refer to [Chapter 2. "Interface Description"](#)). The following list provides some examples of the parameter settings that can be updated on the BM70 module using the UI tool (For the description of features, refer to [Chapter 1. "Overview"](#)):

- Device name
- UART settings
- BLE connection settings
- Add or edit GATT service table

To update the UI parameter settings, perform the following steps:

1. Open the UI tool and click **Load**, refer to [Figure C-1](#). The Loading Option window is displayed.

Note: Download and unzip the contents of the Firmware_Software-Tools_Vx_xx.zip file, which is available from the Microchip product web page at www.microchip.com/BM70. The configuration tool is part of this zip file content and located under the sub-folder "ConfigurationTool". In this demonstration, the IS187x_102_BLEDK3_UI v100.132.exe tool is used. This tool version corresponds to firmware version v1.06. Information is shown by the file name Firmware_SoftwareTools_Vx_xx.zip, where "Vx_xx" is the firmware version.

FIGURE C-1: CONFIGURATION TOOL WINDOW

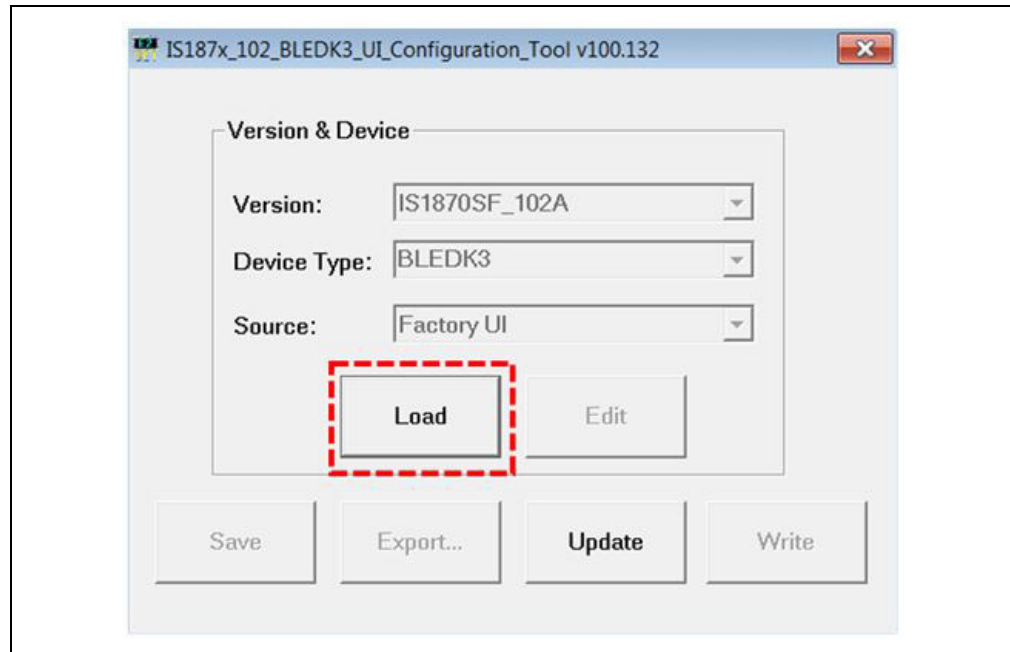

BM-70-CDB Example Configuration

2. In the Loading Option window, click **Load Text File** to load default configuration parameters. Refer to [Figure C-2](#).

FIGURE C-2: Loading Option Window

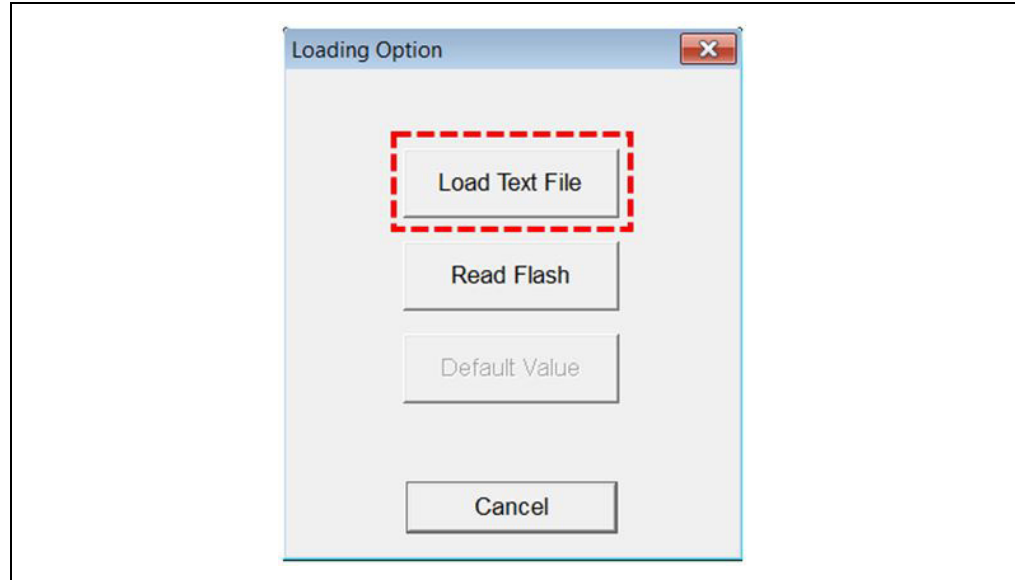

3. From the Open dialog, select the default configuration parameter text file (provided with the `Firmware_SoftwareTools_Vx_xx.zip` file under the "ConfigurationTool" sub-folder) and then click **Open**. Refer to [Figure C-3](#).

FIGURE C-3: OPEN DIALOG BOX TO SELECT DEFAULT CONFIGURATION

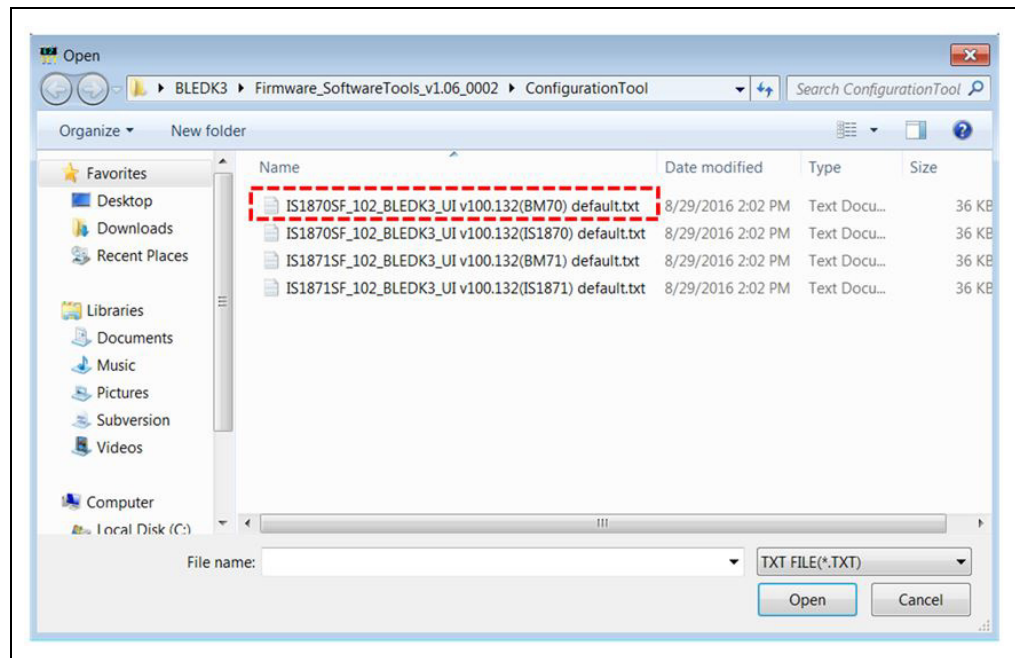

BM70 Compact Demo Board (CDB) User's Guide

- From the Configuration Tool window, click **Edit** to start editing the default parameters. Refer to [Figure C-4](#).

FIGURE C-4: CONFIGURATION TOOL WINDOW – EDIT OPTION

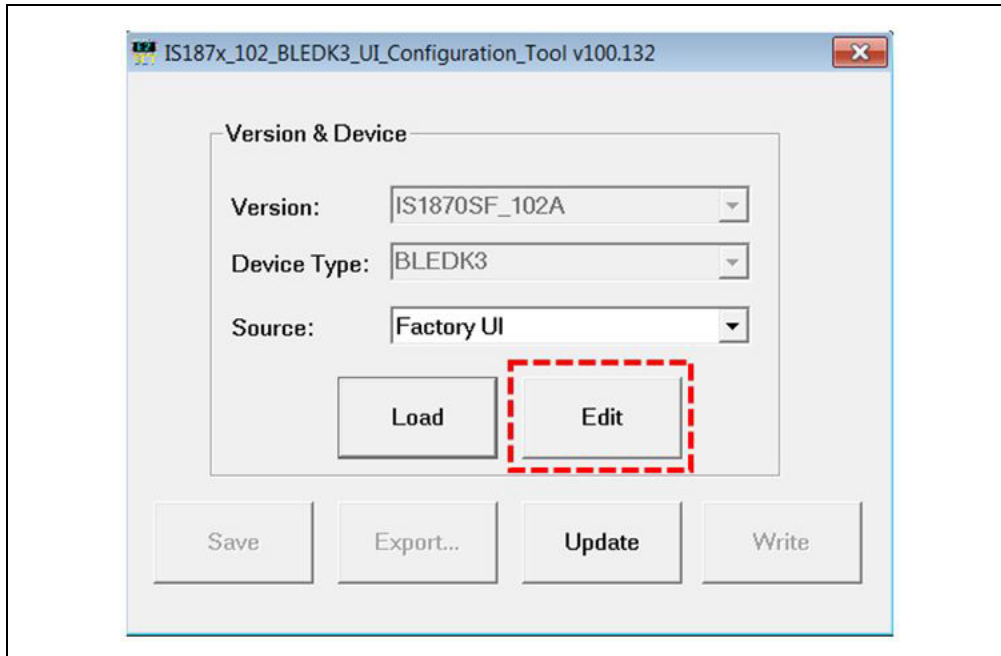

- From the Main Feature window, click **BLEDK** and then **OK**. Refer to [Figure C-5](#).

FIGURE C-5: MAIN FEATURE WINDOW

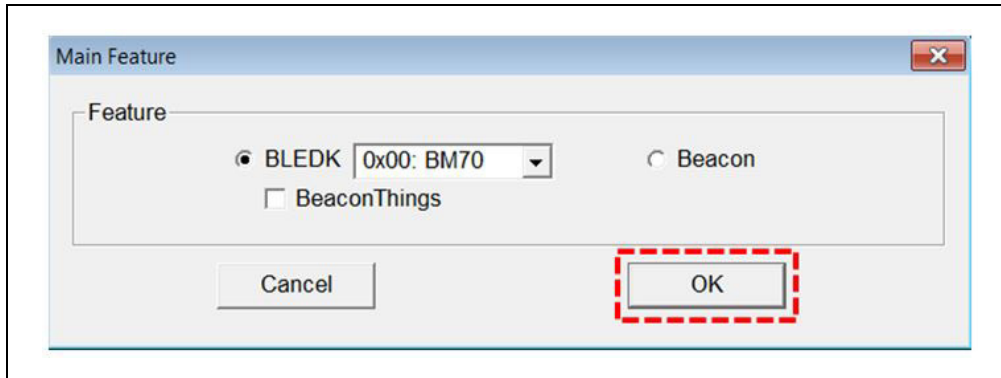

- The UI tool displays a window with various configuration options (tabs) in a tabular format. Click the **System Setup** tab, and type "BM70_BLE" (or any user-defined name) in the Name fragment box. Refer to [Figure C-6](#).

Note: Click the **Help** button to get information related to UI parameters.

BM-70-CDB Example Configuration

FIGURE C-6: CONFIGURING PARAMETERS – SYSTEM SETUP

The screenshot displays the 'System Setup2' configuration window. At the top, a tab bar shows 'System Setup' (highlighted with a red dashed box), 'System Setup2', 'LE Mode Setup', 'GATT Service Table', 'LED Setup', and 'Beacon Setup'. The main area is divided into several sections:

- Device Information:** 'Name Fragment' is set to 'BM70_BLE' (highlighted with a red dashed box) with a character count of [32 characters]. A 'Help' button is present.
- Uart Setting:** 'HCI Baud Rate Index' is a dropdown menu. 'H/W Flow Control' is set to 'Disable'. 'Check Rx Data Interval' is '0x00' (unit: 0.625ms, total: 0.000 ms). 'UART RX_IND' is set to 'Enable'. A 'Help' button is present.
- Operation Mode Setting:** 'Operation Pattern' is set to 'Auto Pattern'. 'Configure Mode Timeout' is '0x00' (unit: 640ms, total: 0 ms). A 'Help' button is present.
- Standby Mode Setting:** 'Power On Standby Time' is '0x0C'. A 'Help' button is present.

At the bottom, there are three buttons: 'Previous', 'Next', and 'Finish'.

7. Click the **LE Mode Setup** tab. In the Advertising Data Setting section, select Device Name to advertise the device name as shown in [Figure C-7](#). This ensures that the name fragment is included in the advertising packet.

BM70 Compact Demo Board (CDB) User's Guide

FIGURE C-7: CONFIGURING PARAMETERS – LE MODE SETUP

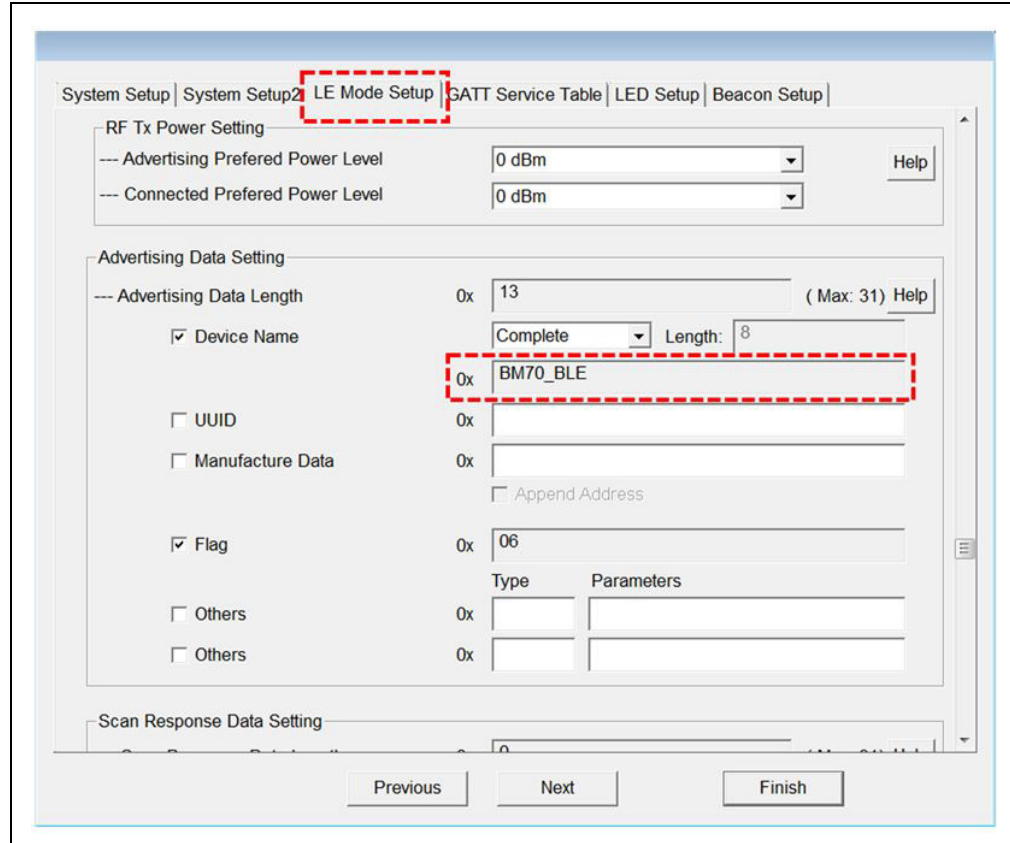

8. Click **Finish**. The Configuration Tool main window is displayed. Refer to [Figure C-8](#).

FIGURE C-8: CONFIGURATION TOOL WINDOW

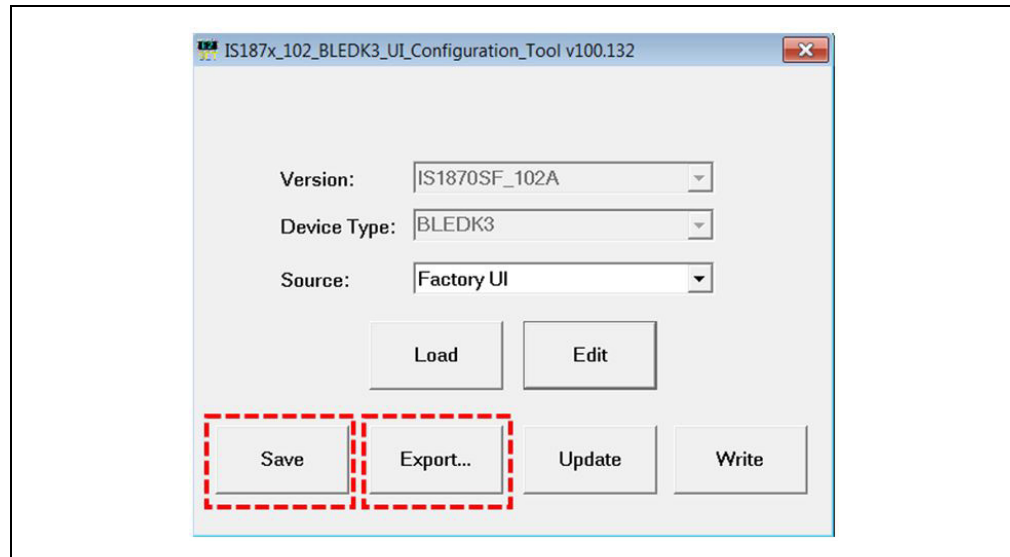

9. From the Configuration Tool window, perform one of these actions:
- Click **Save** to save the selected parameter settings as `.txt` or `.hex` files (used for later production programming).
 - Click **Export** to export a log file along with the parameters to a `.txt` file. The log file contains the configuration parameters settings which are edited.

BM-70-CDB Example Configuration

- To program the configuration parameters on the BM70 module, perform the following steps:
 - Connect the BM-70-CDB to the host PC using the Micro-USB cable.
 - Verify that the USB power is selected in J6 (close Pin 2 and Pin 3) and J8 (current measurement test point) is closed.
 - Verify that the Switch 2 on SW2 is set to ON position.
 - Press **SW1** (Reset) button and verify that LD2 is showing a non-flashing blue that indicates the BM70 is in programming mode.
 - Go to the Configuration Tool window and click **Write** to program the settings into the internal memory of the BM70 module. Refer to [Figure C-9](#).

FIGURE C-9: WRITE CONFIGURATION

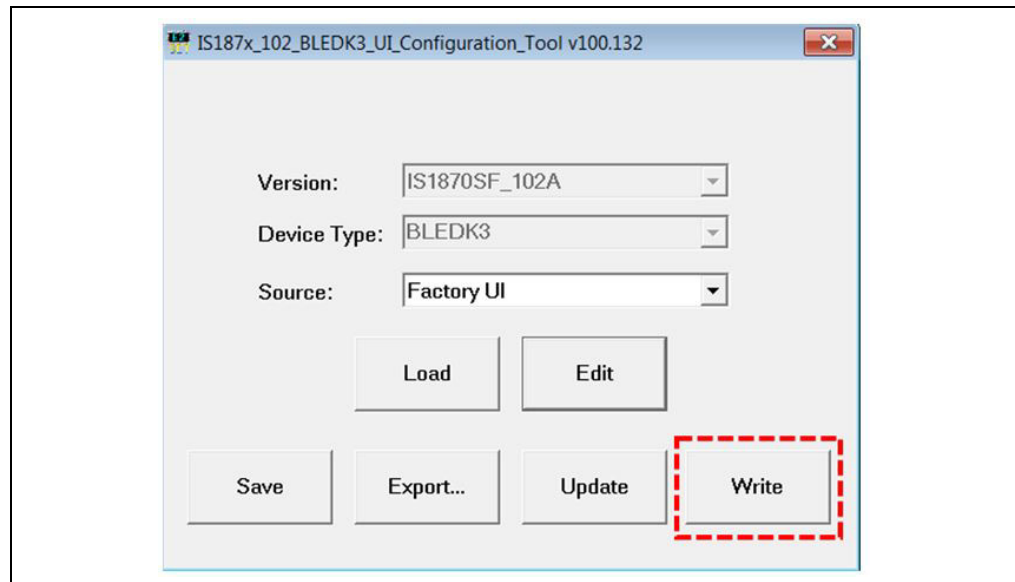

- The Read/Write Flash window is displayed. Select the values for COM Port and Baudrate (must be 115200 for the configuration to succeed), and then click **Write**. Refer to [Figure C-10](#).

FIGURE C-10: COM SETTINGS TO WRITE CONFIGURATION

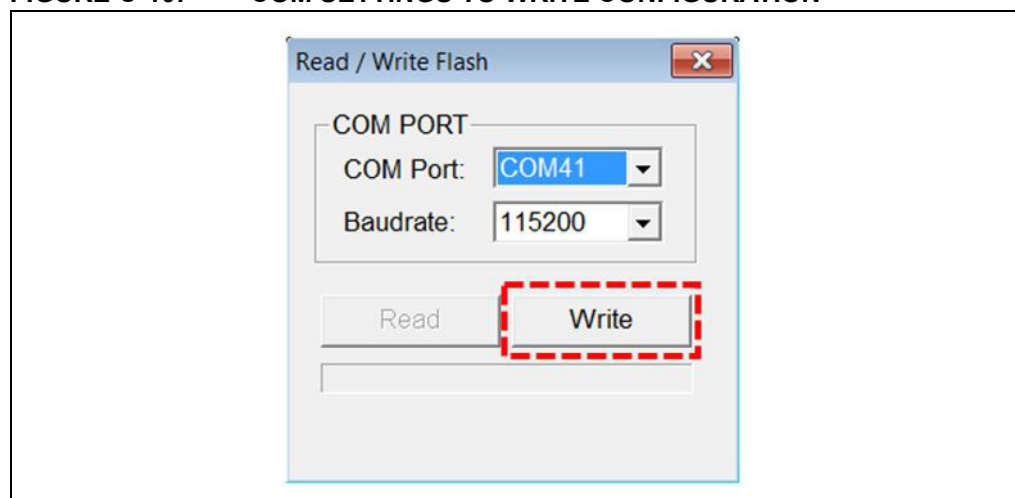

BM70 Compact Demo Board (CDB) User's Guide

- A message box appears displaying the message "Write the UI configuration settings to EFLASH! Are you sure?". Click **Yes** to write the configuration. Refer to [Figure C-11](#).

FIGURE C-11: WRITE EFLASH ALERT

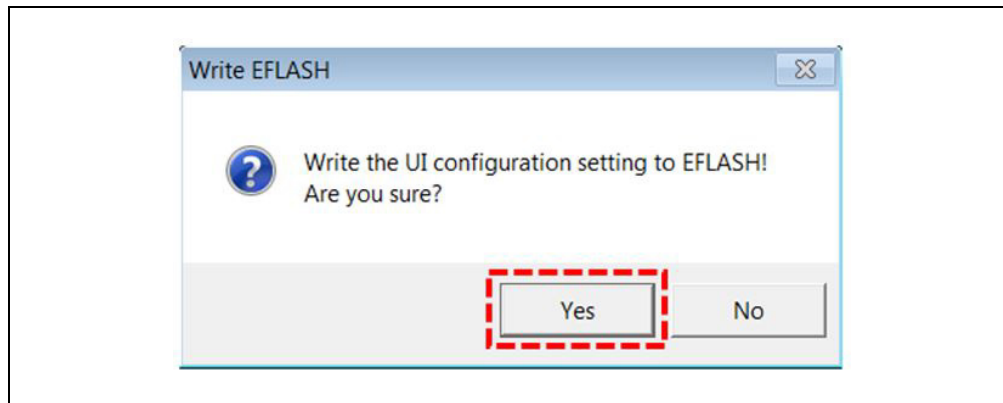

- A message box appears displaying the message "Write Flash Finish". Click **OK** to finish. Refer to [Figure C-12](#).

FIGURE C-12: WRITE EFLASH FINISH

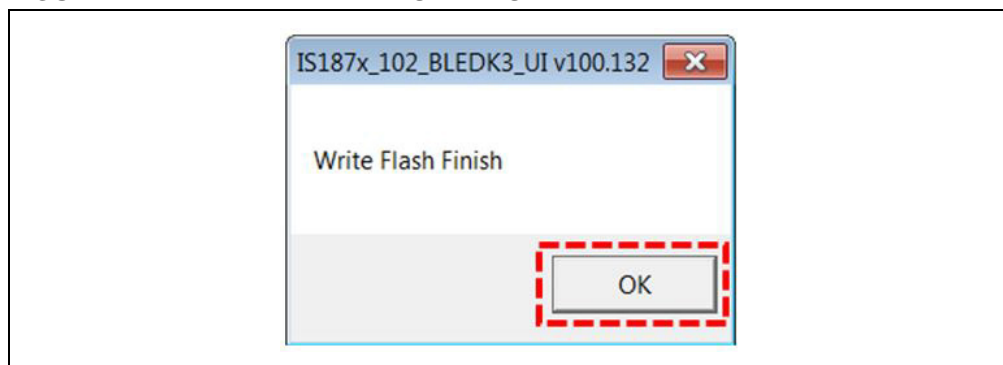



BM70 COMPACT DEMO BOARD (CDB) USER'S GUIDE

Appendix D. Schematics and BOM

D.1 INTRODUCTION

This appendix provides the schematics and the Bill of Materials (BOM) for the BM-70-CDB:

- [BM-70-CDB Schematic](#)
- [BM-70-CDB BOM](#)
- [RN4870 Sensor Board Schematic](#)
- [RN4870 Sensor Board BOM](#)

D.2 BM-70-CDB SCHEMATIC

Figure D-1 shows the schematic for the BM-70-CDB.

FIGURE D-1: BM-70-CDB SCHEMATIC

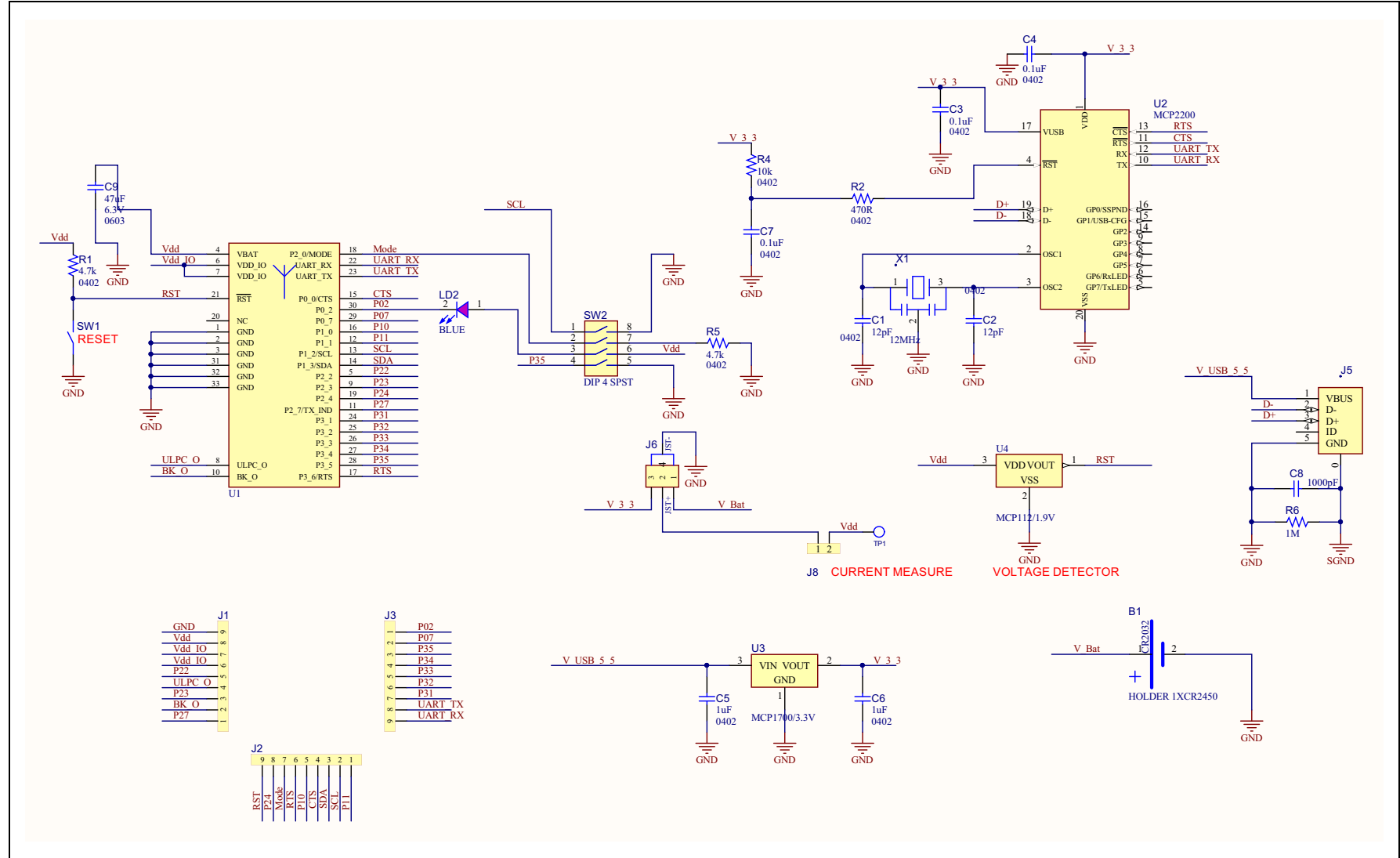

D.3 BM-70-CDB BOM

Table D-1 shows the Bill of Materials for the BM-70-CDB.

TABLE D-1: BM-70-CDB BOM

Qty	Designator	Description	Manufacturer	Manufacturer Part Number
1	B1	BATT HOLDER COIN 1 TH CR2450	Keystone Electronics	1053
2	C1, C2	CAP CER 12pF 50V 1% NP0 SMD 0402	Murata Electronics North America	GRM1555C1H120FA01D
3	C3, C4, C7	CAP CER 0.1uF 10V 10% X5R SMD 0402	KEMET	C0402C104K8PACTU
2	C5, C6	CAP CER 1uF 10V 10% X5R SMD 0402	Murata Electronics North America	GRM155R61A105KE15D
1	C8	CAP CER 1000pF 25V 5% C0G SMD 0402	TDK	C1005C0G1E102J
1	C9	CAP CER 47uF 6.3V 20% X5R SMD 0603	Murata Electronics North America	GRM188R60J476ME15D
3	J1, J2, J3	CON HDR-2.54 Male 1x9 Gold 5.84MH TH VERT	Samtec	TSW-109-07-G-S
1	J5	CON USB2.0 MICRO-B FEMALE TH/SMD R/A	FCI	10118194-0001LF
1	J6	CON HDR-2.54 Male 1x3 Gold 6.0MH TH VERT	JAMECO VALUEPRO	7000-1X3SG-R
1	J8	CON HDR-2.54 Male 1x2 Gold 5.84MH TH VERT	FCI	77311-118-02LF
1	LD2	DIO LED BLUE 3.2V 20mA 140mcd Clear SMD 1206	Dialight	598-8291-107F
2	R1, R5	RES TKF 4.7K 1% 1/10W 0402	KOA Speer	RK73H1ETTP4701F
1	R2	RES TKF 470R 5% 1/16W SMD 0402	Panasonic	ERJ-2GEJ471X
1	R4	RES TF 10k 0.5% 1/16W SMD 0402	SUSUMU	RR0510P-103-D
1	R6	RES TKF 1M 5% 1/16W SMD 0402	Yageo	RC0402JR-071ML
1	SW1	SWITCH TACT SPST 12V 50mA RS-282G05A3-SM RT	C&K Components	RS-282G05A3-SM RT
1	SW2	SWITCH DIP 4 SPST 24V 25mA 418121270804 SMD	Würth Electronics Inc.	418121270804
1	X1	RESONATOR 12MHz 0.1% SMD CSTCE-G	Murata Electronics North America	CSTCE12M0G15L99-R0
1	U1	MCHP RF BLUETOOTH BM70BLES1FC2 MODULE-33	Microchip Technology Inc.	BM70BLES1FC2
1	U2	MCHP INTERFACE USB UART MCP2200-I/SS SSOP-20	Microchip Technology Inc.	MCP2200T-I/SS
1	U3	MCHP ANALOG LDO 3.3V MCP1700T-3302E/TT SOT-23-3	Microchip Technology Inc.	MCP1700T-3302E/TT
1	U4	MCHP ANALOG VOLATGE DETECTOR 1.9V MCP112T-195I/TT SOT-23-3	Microchip Technology Inc.	MCP112T-195I/TT

TABLE D-2: RN4870 SENSOR BOARD BOM (CONTINUED)

Oty	Reference	Description	Manufacturer	Manufacturer Part Number
1	SW1	SWITCH TACT SPST 12V 50 mA PTS645SM43SMTR92 LFS SMD	C&K Components	PTS645SM43SMTR92 LFS
1	SW2	SWITCH DIP 4-POS SLIDE SMD 6V	Copal Electronics Inc.	CHS-04TB
3	TP1, TP2, TP3	MISC, TEST POINT MULTI PURPOSE MINI BLACK	Keystone	5001

BM70 Compact Demo Board (CDB) User's Guide

NOTES:

Appendix E. Bluetooth Low Energy Primer

E.1 GAP ROLES: PERIPHERAL AND CENTRAL

When two Bluetooth Low Energy (BLE) devices want to be connected, one device must be in Central role and the other in Peripheral role. The Peripheral device advertises to show its connectable status, while Central device scans service advertisements, and if needed, initiates a connection to the Peripheral device. Once connected, either end of the connection can choose to bond. Once bonded, all security related keys are saved and security process are waived when reconnecting. Bonded peripheral device can only perform direct advertise, therefore, unable to connect to a device other than its bonded peer.

E.2 GATT SERVICE: CLIENT AND SERVER

Similar to Bluetooth Classic, BLE uses the concept of profiles to ensure interoperability between different devices. As illustrated in [Figure E-1](#), BLE profiles are collection of services. All BLE services are built on top of Generic Attribute Profile (GATT) where GATT defines accessibility of attributes called characteristics. The main functionality of the BLE profiles, therefore, is built around the characteristics. For those devices that maintain the value of characteristics in a service, such device is the Server of the service. On the other hand, devices that acquire data from their peer are called Client.

Each service and its characteristics can be identified by their Universally Unique Identifier (UUID). The UUID can be a short form (16-bit) or long form (128-bit). As specified by Bluetooth Core Specifications, all Bluetooth SIG adopted (public) services and characteristics have short UUID (16-bit), while user defined private UUIDs are in long form (128-bit). For the details of Bluetooth SIG adopted services and characteristics, please refer to <https://developer.bluetooth.org/gatt/profiles/Pages/ProfilesHome.aspx>.

The accessibility of each characteristic is defined by a 8-bit characteristic property in bitmap format, as shown in [Table E-1](#).

TABLE E-1: CHARACTERISTIC PROPERTIES

Property	Bitmap Value	Description
Extended Property ⁽¹⁾	0x80	Additional property available
Authenticated Write ⁽¹⁾	0x40	Write characteristic with authentication from Client to Server
Indicate	0x20	Indicate value of characteristic with acknowledgment from Server to Client
Notify	0x10	Notify value of characteristic without acknowledgment from Server to Client
Write	0x08	Write value of characteristic with acknowledgment from Client to Server
Write without response	0x04	Write value of characteristic without acknowledgment from Client to Server
Read	0x02	Read value of characteristic. Value is sent from Server to Client
Broadcast ⁽¹⁾	0x01	Broadcast value of characteristic

Note 1: These features are supported in the future firmware releases.

BM70 Compact Demo Board (CDB) User's Guide

As shown in Figure E-1, the GATT client can access the characteristics in the GATT server in the Peripheral device. When connected, the GATT client reads the GATT server service and characteristic UUIDs. The characteristic values can be accessed by the GATT client using Write, Read, Indication and Notifications.

Write-REQ enables the GATT client to update characteristic values on the Peripheral's GATT server. The write requests can be performed using RN4870 `CHW` and `CUW` commands. Refer to Section 4.6 "Accessing GATT Service Using UART Commands And SmartDiscover App" for more information on GATT characteristic access commands.

Write-CMD performs an unacknowledged write from a GATT client to the GATT server. This is allowed for Transparent UART Write procedure on the RN4870 when `SR, 0100` command is used.

A GATT client sends Read-REQ read a characteristic value on the Peripheral's GATT server. The read requests can be performed using RN4870 `CHR` and `CUR` commands.

Notifications and Indications are unsolicited updates sent from the GATT server to the GATT client. The GATT client must enable the Notification and Indication on a characteristic to receive the updates. On the RN4870 module, this is done by using the `CUW` or `CHW` command to write non-zero value to the Notification Characteristic. When RN4870 in Client mode receives a notification, the `%WC, hhhh, dddddd%` message is returned on UART in Command mode.

FIGURE E-1: GATT SERVICE

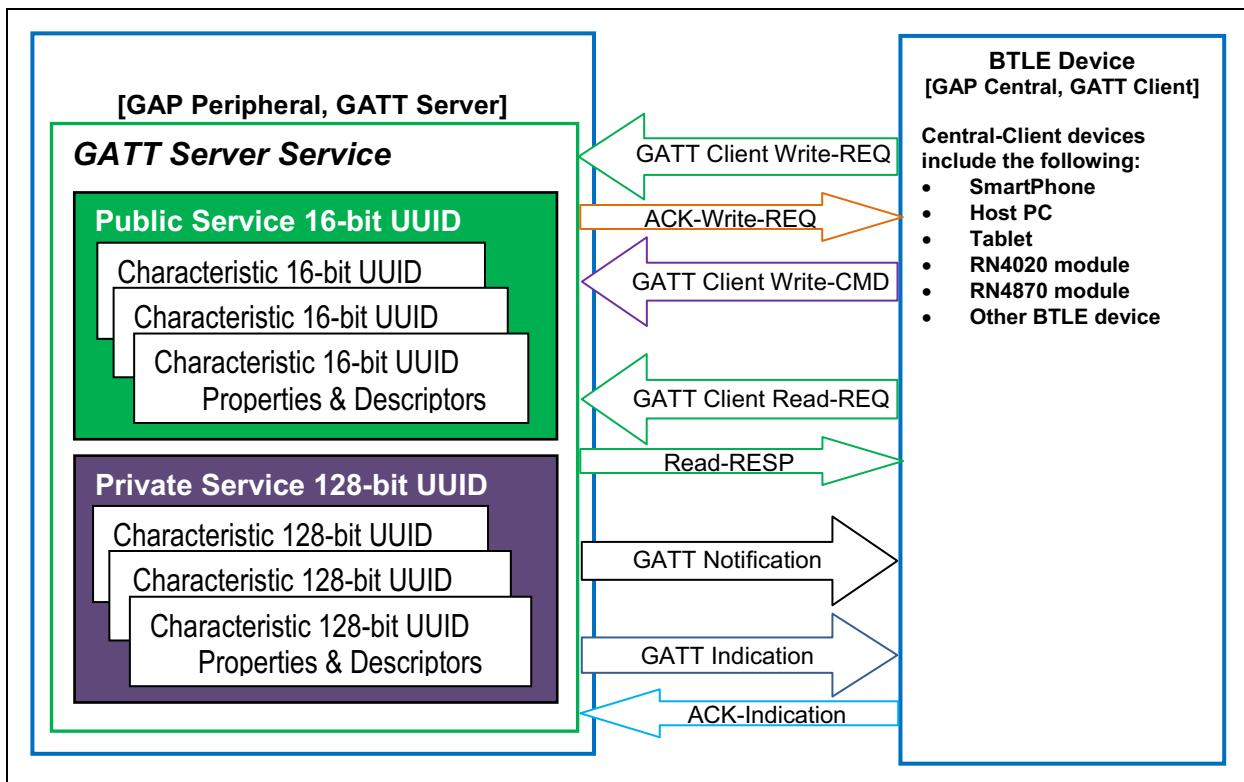

Appendix F. Sensor Board Script Text

F.1 OVERVIEW

This appendix provides a configuration text example for the Sensor Board Script.

F.2 SENSOR BOARD SCRIPT

To configure the Sensor Board, enter the following sequence of commands:

```
@PW_ON
IA, Z
IA, 01, 06
IA, FF, CD00FE14AD11CF40063F11E5BE3E0002A5D5C51B
%0078 = ?FUNC1
?FUNC1
[, 1, 1, $PM1, $PM2
@DISCON
SM, 1, 0000
SM, 2, 0000
SM, 3, 0000
R, 1
@CONN
SM, 1, 0002
SM, 2, 000A
SM, 3, 000A
@TMR3
$VAR2 = @, 1
SHW, 0075, $VAR2
SM, 3, 000A
@TMR2
$VAR2 = @, 0
SHW, 0072, $VAR2
SM, 2, 000A
@TMR1
$VAR2 = @, 5
SHW, 007B, $VAR2
$VAR2 = @, 4
SHW, 007E, $VAR2
SM, 1, 0002
@PIO1L
SHW, 0078, 0001
@PIO1H
SHW, 0078, 0000
```

BM70 Compact Demo Board (CDB) User's Guide

NOTES:

Appendix G. Transparent UART

G.1 INTRODUCTION

The Transparent UART Service is instantiated as a Primary Service. The service UUID of the Transparent UART Service is set to 49535343-FE7D-4AE5-8FA9-9FAFD205E455. The Transparent UART Service contains the following data Characteristics:

- Transparent UART Transmit (TX) Characteristic
- Transparent UART Receive (RX) Characteristic

The Transparent UART TX Characteristic is used for data transmission by the Server or the Client. Once the Client Characteristic Configuration Descriptor (CCCD) of Transparent UART TX Characteristic is enabled, the Server sends data to the Client using the Notify property. The Client can also send data to the Server using the Write/Write without response properties.

The Transparent UART RX Characteristic is used for data transmission by the Client. The Client can send data to the Server using the Write/Write without response properties.

[Table G-1](#) shows the UUIDs and the properties of the data characteristics.

TABLE G-1: CHARACTERISTIC PROPERTIES

Characteristic Name	UUID	Properties
Transparent UART TX	49535343-1E4D-4BD9-BA61-23C647249616	Notify, Write, Write without response
Transparent UART RX	49535343-8841-43F4-A8D4-ECBE34729BB3	Write, Write without response

BM70 Compact Demo Board (CDB) User's Guide

NOTES:



MICROCHIP

Worldwide Sales and Service

AMERICAS

Corporate Office

2355 West Chandler Blvd.
Chandler, AZ 85224-6199

Tel: 480-792-7200

Fax: 480-792-7277

Technical Support:

<http://www.microchip.com/support>

Web Address:

www.microchip.com

Atlanta

Duluth, GA

Tel: 678-957-9614

Fax: 678-957-1455

Austin, TX

Tel: 512-257-3370

Boston

Westborough, MA

Tel: 774-760-0087

Fax: 774-760-0088

Chicago

Itasca, IL

Tel: 630-285-0071

Fax: 630-285-0075

Dallas

Addison, TX

Tel: 972-818-7423

Fax: 972-818-2924

Detroit

Novi, MI

Tel: 248-848-4000

Houston, TX

Tel: 281-894-5983

Indianapolis

Noblesville, IN

Tel: 317-773-8323

Fax: 317-773-5453

Tel: 317-536-2380

Los Angeles

Mission Viejo, CA

Tel: 949-462-9523

Fax: 949-462-9608

Tel: 951-273-7800

Raleigh, NC

Tel: 919-844-7510

New York, NY

Tel: 631-435-6000

San Jose, CA

Tel: 408-735-9110

Tel: 408-436-4270

Canada - Toronto

Tel: 905-695-1980

Fax: 905-695-2078

ASIA/PACIFIC

Asia Pacific Office

Suites 3707-14, 37th Floor
Tower 6, The Gateway
Harbour City, Kowloon

Hong Kong

Tel: 852-2943-5100

Fax: 852-2401-3431

Australia - Sydney

Tel: 61-2-9868-6733

Fax: 61-2-9868-6755

China - Beijing

Tel: 86-10-8569-7000

Fax: 86-10-8528-2104

China - Chengdu

Tel: 86-28-8665-5511

Fax: 86-28-8665-7889

China - Chongqing

Tel: 86-23-8980-9588

Fax: 86-23-8980-9500

China - Dongguan

Tel: 86-769-8702-9880

China - Guangzhou

Tel: 86-20-8755-8029

China - Hangzhou

Tel: 86-571-8792-8115

Fax: 86-571-8792-8116

China - Hong Kong SAR

Tel: 852-2943-5100

Fax: 852-2401-3431

China - Nanjing

Tel: 86-25-8473-2460

Fax: 86-25-8473-2470

China - Qingdao

Tel: 86-532-8502-7355

Fax: 86-532-8502-7205

China - Shanghai

Tel: 86-21-3326-8000

Fax: 86-21-3326-8021

China - Shenyang

Tel: 86-24-2334-2829

Fax: 86-24-2334-2393

China - Shenzhen

Tel: 86-755-8864-2200

Fax: 86-755-8203-1760

China - Wuhan

Tel: 86-27-5980-5300

Fax: 86-27-5980-5118

China - Xian

Tel: 86-29-8833-7252

Fax: 86-29-8833-7256

ASIA/PACIFIC

China - Xiamen

Tel: 86-592-2388138

Fax: 86-592-2388130

China - Zhuhai

Tel: 86-756-3210040

Fax: 86-756-3210049

India - Bangalore

Tel: 91-80-3090-4444

Fax: 91-80-3090-4123

India - New Delhi

Tel: 91-11-4160-8631

Fax: 91-11-4160-8632

India - Pune

Tel: 91-20-3019-1500

Japan - Osaka

Tel: 81-6-6152-7160

Fax: 81-6-6152-9310

Japan - Tokyo

Tel: 81-3-6880-3770

Fax: 81-3-6880-3771

Korea - Daegu

Tel: 82-53-744-4301

Fax: 82-53-744-4302

Korea - Seoul

Tel: 82-2-554-7200

Fax: 82-2-558-5932 or

82-2-558-5934

Malaysia - Kuala Lumpur

Tel: 60-3-6201-9857

Fax: 60-3-6201-9859

Malaysia - Penang

Tel: 60-4-227-8870

Fax: 60-4-227-4068

Philippines - Manila

Tel: 63-2-634-9065

Fax: 63-2-634-9069

Singapore

Tel: 65-6334-8870

Fax: 65-6334-8850

Taiwan - Hsin Chu

Tel: 886-3-5778-366

Fax: 886-3-5770-955

Taiwan - Kaohsiung

Tel: 886-7-213-7830

Taiwan - Taipei

Tel: 886-2-2508-8600

Fax: 886-2-2508-0102

Thailand - Bangkok

Tel: 66-2-694-1351

Fax: 66-2-694-1350

EUROPE

Austria - Wels

Tel: 43-7242-2244-39

Fax: 43-7242-2244-393

Denmark - Copenhagen

Tel: 45-4450-2828

Fax: 45-4485-2829

Finland - Espoo

Tel: 358-9-4520-820

France - Paris

Tel: 33-1-69-53-63-20

Fax: 33-1-69-30-90-79

France - Saint Cloud

Tel: 33-1-30-60-70-00

Germany - Garching

Tel: 49-8931-9700

Germany - Haan

Tel: 49-2129-3766400

Germany - Heilbronn

Tel: 49-7131-67-3636

Germany - Karlsruhe

Tel: 49-721-625370

Germany - Munich

Tel: 49-89-627-144-0

Fax: 49-89-627-144-44

Germany - Rosenheim

Tel: 49-8031-354-560

Israel - Ra'anana

Tel: 972-9-744-7705

Italy - Milan

Tel: 39-0331-742611

Fax: 39-0331-466781

Italy - Padova

Tel: 39-049-7625286

Netherlands - Drunen

Tel: 31-416-690399

Fax: 31-416-690340

Norway - Trondheim

Tel: 47-7289-7561

Poland - Warsaw

Tel: 48-22-3325737

Romania - Bucharest

Tel: 40-21-407-87-50

Spain - Madrid

Tel: 34-91-708-08-90

Fax: 34-91-708-08-91

Sweden - Gothenberg

Tel: 46-31-704-60-40

Sweden - Stockholm

Tel: 46-8-5090-4654

UK - Wokingham

Tel: 44-118-921-5800

Fax: 44-118-921-5820