

### LED

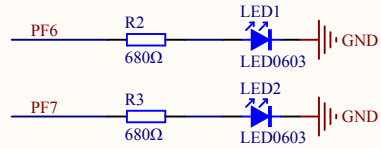

### KEY

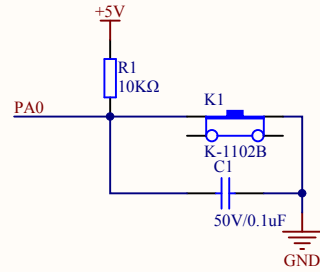

### Extension Pin

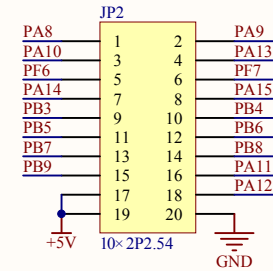
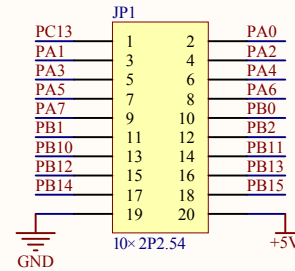

**Company Name: GigaDevice**

**File Name: Extension**

Revision: 1.0

Data: 2013-9-13

Author: XuFei

### MCU SWD

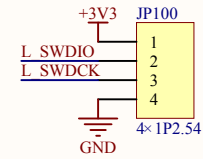

### HSE

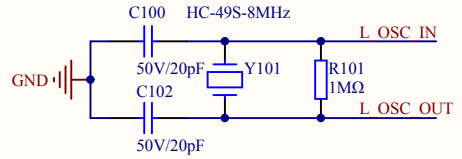

### Reset

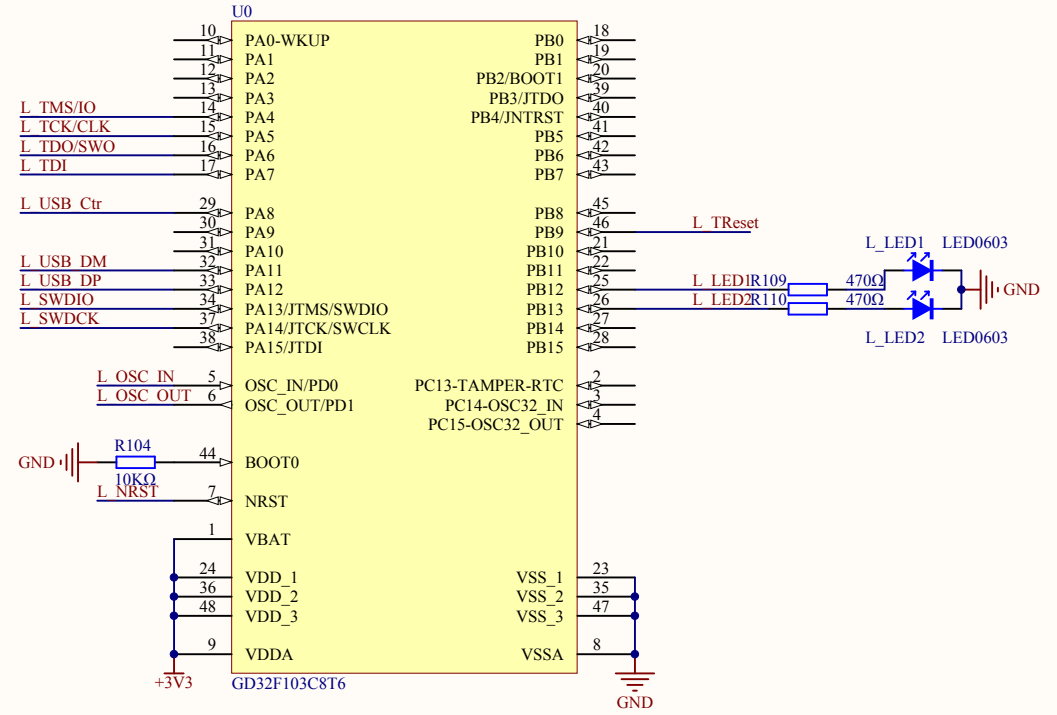
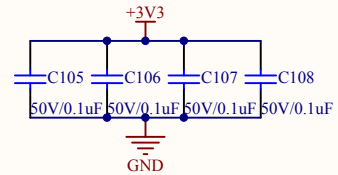
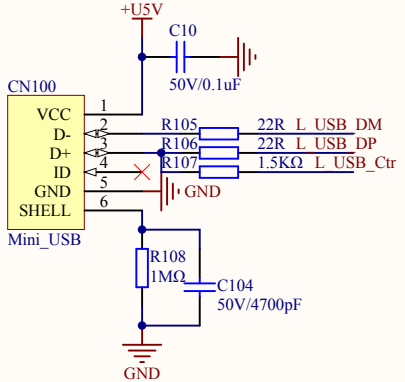
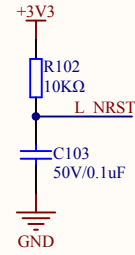

Company Name: GigaDevice

File Name: GDLink

Revision: 1.0

Data: 2015-01-09

Author: XuFei

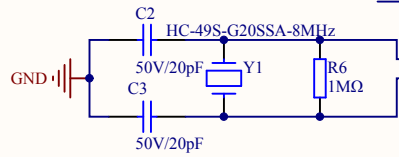
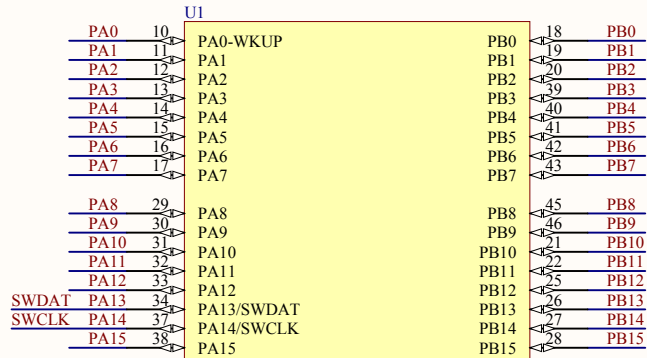
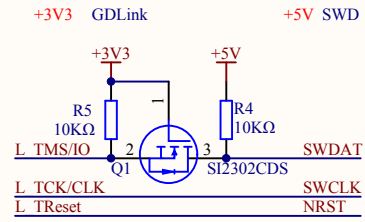

PC13-TAMPER-RTC  
PC14-OSC32\_IN  
PC15-OSC32\_OUT

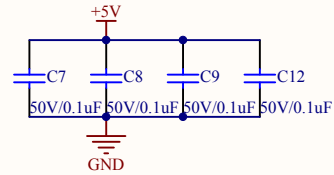
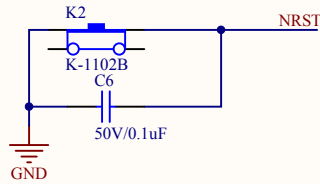
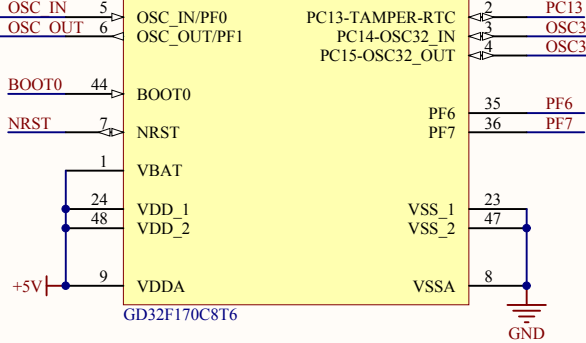
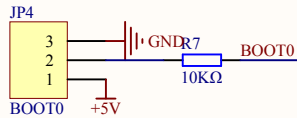
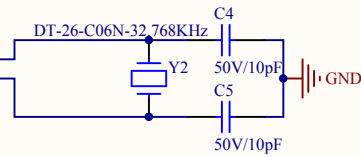

<b>Company Name: GigaDevice</b>		
<b>File Name: MCU</b>		
Revision: 1.0	Data: 2016-2	Author: XuFei

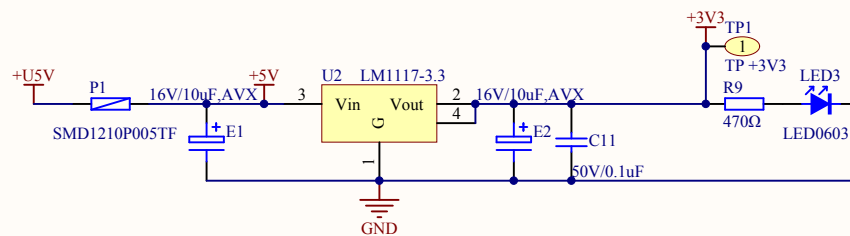

<b>Company Name: GigaDevice</b>		
<b>File Name: Power</b>		
Revision: 1.1	Data: 2015-07	Author: XuFei

