

## IGBT Modules



**V<sub>CES</sub>**            1200V  
**I<sub>C</sub>**                 200A

### Applications

- Industrial Inverters
- Servo Applications
- SMPS UPS
- Induction Heating

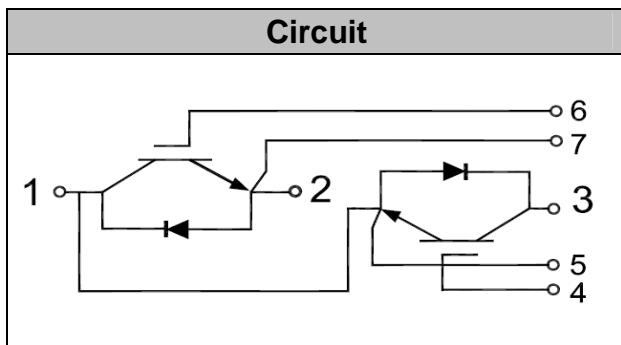

### Features

- Short Circuit Rated 10 $\mu$ s
- Low Stray Inductance
- Low Saturation Voltage
- Ultra Low loss
- HI-REL Power Terminals
- Lead Free, Compliant With RoHS Requirement

### Absolute Maximum Ratings (T<sub>C</sub> = 25°C unless otherwise specified)

Symbol	Description	Values	Units	
V <sub>CES</sub>	Collector - Emitter Voltage	1200	V	
V <sub>GES</sub>	Gate-Emitter Voltage	±20	V	
I <sub>C</sub>	DC Collector Current	T <sub>C</sub> =25°C	300	A
		T <sub>C</sub> =80°C	200	A
I <sub>CM</sub>	Repetitive Peak Collector Current	t <sub>p</sub> =1ms	400	A
P <sub>tot</sub>	Power Dissipation Per IGBT		1150	W
T <sub>J</sub>	Junction Temperature Range		40 to +150	°C
T <sub>STG</sub>	Storage Temperature Range		40 to +125	°C
Viso	Insulation Test Voltage	AC, t=1min	3000	V
Mounting Torque	Power Terminals Screw: M6		5±15%	N*m
	Mounting Screw:M6		5±15%	N*m

Notes :

(1) Repetitive Rating: Pulse width limited by max. junction temperature



## Electrical Characteristics of IGBT ( $T_J = 25^\circ\text{C}$ unless otherwise specified)

Symbol	Item	Conditions	Values			Units
			Min.	Typ.	Max.	
<b>OFF Characteristics</b>						
$V_{(BR)CES}$	Collector-Emitter Breakdown Voltage	$V_{GE} = 0V, I_C = 1mA$	1200			V
$I_{CES}$	Collector Leakage Current	$V_{CE}=1200V, V_{GE}=0V, T_J=25^\circ\text{C}$		0.4	1	mA
		$V_{CE}=1200V, V_{GE}=0V, T_J=125^\circ\text{C}$			5	mA
$I_{GES}$	Gate Leakage Current	$V_{CE}=0V, V_{GE}=\pm 20V$	-400		400	nA
<b>ON Characteristics</b>						
$V_{GE(th)}$	Gate - Emitter Threshold Voltage	$V_{CE}=V_{GE}, I_C=6mA$	5.5	6	6.5	V
$V_{CE(sat)}$	Collector – Emitter Saturation Voltage	$I_C=150A, V_{GE}=15V, T_J=25^\circ\text{C}$		2		V
		$I_C=150A, V_{GE}=15V, T_J=125^\circ\text{C}$		2.4		V
<b>Dynamic Characteristics</b>						
$C_{ies}$	Input Capacitance	$V_{CE}=25V, V_{GE}=0V, f=1MHz$		12.5		nF
$C_{oes}$	Output Capacitance			1.04		nF
$C_{res}$	Reverse Transfer Capacitance			0.7		nF
<b>Switching Characteristics</b>						
$t_{d(on)}$	Turn-on Delay Time	$V_{CC}=600V, I_C=200A, R_G=5\Omega, V_{GE}=\pm 15V, T_J=25^\circ\text{C}$ Inductive Load		125		ns
$t_r$	Rise Time			60		ns
$t_{d(off)}$	Turn-off Delay Time			420		ns
$T_f$	Fall Time			60		ns
$E_{on}$	Turn-on Switching Loss	$V_{CC}=600V, I_C=200A, R_G=5\Omega, V_{GE}=\pm 15V$ Inductive Load	$T_J=25^\circ\text{C}$	17		mJ
			$T_J=125^\circ\text{C}$	24.8		mJ
$E_{off}$	Turn-off Switching Loss		$T_J=25^\circ\text{C}$	13.6		mJ
			$T_J=125^\circ\text{C}$	21.6		mJ
$t_{d(on)}$	Turn-on Delay Time	$V_{CC}=600V, I_C=200A, R_G=5\Omega, V_{GE}=\pm 15V, T_J=125^\circ\text{C}$ Inductive Load		135		ns
$t_r$	Rise Time			60		ns
$t_{d(off)}$	Turn-off Delay Time			490		ns
$T_f$	Fall Time			75		ns
$Q_{ge}$	Gate Charge	$V_{CC}=600V, I_C=150A, V_{GE}=\pm 15V$		2100		nC
RBSOA	Reverse Bias Safe Operating Area	$I_C = 200A, V_{CC} = 600V, V_p = 1200V, R_g = 10\Omega, V_{GE} = +15V \text{ to } 0V, T_J = 150^\circ\text{C}$	Trapezoid			
SCSOA	Short Circuit Safe Operating Area	$V_{CC} = 600V, V_{GE} = 15V, T_J = 150^\circ\text{C}$	10			$\mu\text{s}$



## Electrical Characteristics of FWD (T<sub>C</sub> = 25°C unless otherwise specified)

Symbol	Item	Conditions	Min.	Typ.	Max.	Units	
V <sub>FM</sub>	Forward Voltage	I <sub>F</sub> = 150A, V <sub>GE</sub> = 0V	T <sub>J</sub> = 25°C		2.0	2.44	V
			T <sub>J</sub> = 125°C		1.7	2.20	
t <sub>rr</sub>	Reverse Recovery Time	I <sub>F</sub> = 100A, R <sub>g</sub> = 10Ω, di/dt = 1000A/μs, V <sub>rr</sub> = 600V, V <sub>GE</sub> = ±15V	T <sub>J</sub> = 25°C		230		ns
			T <sub>J</sub> = 125°C		260		
I <sub>rr</sub>	Peak Reverse Recovery Current	I <sub>F</sub> = 100A, R <sub>g</sub> = 10Ω, di/dt = 1000A/μs, V <sub>rr</sub> = 600V, V <sub>GE</sub> = ±15V	T <sub>J</sub> = 25°C		90		A
			T <sub>J</sub> = 125°C		110		
Q <sub>rr</sub>	Reverse Recovery Charge	I <sub>F</sub> = 100A, R <sub>g</sub> = 10Ω, di/dt = 1000A/μs, V <sub>rr</sub> = 600V, V <sub>GE</sub> = ±15V	T <sub>J</sub> = 25°C		10.5		μC
			T <sub>J</sub> = 125°C		13.5		

## Thermal Resistance Characteristics

Symbol	Description	Min.	Typ.	Max.	Units
R <sub>θJC</sub>	Junction-To-Case (IGBT Part, Per Leg)			0.09	°C/W
R <sub>θJC</sub>	Junction-To-Case (Diode Part, Per Leg)			0.22	°C/W
Mt	Power Terminals Screw:M5	3		5	N·m
Ms	Mounting Screw:M6	3		5	N·m
Weight	Weight Of Module			300	g

## Performance Curves

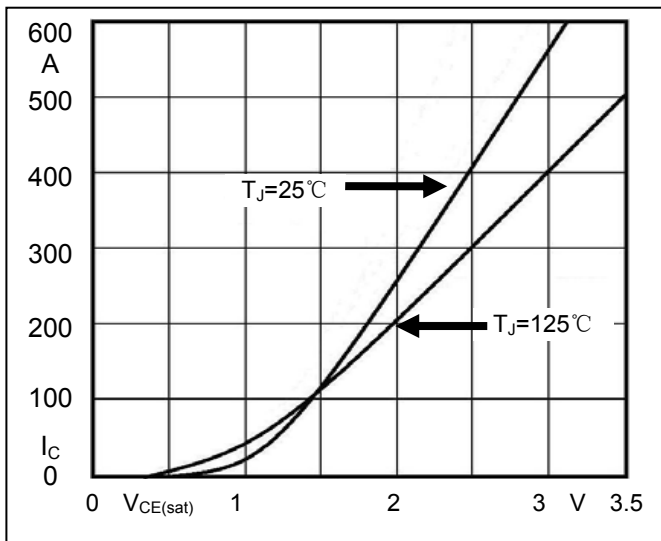

Fig1. Typical Output Characteristics

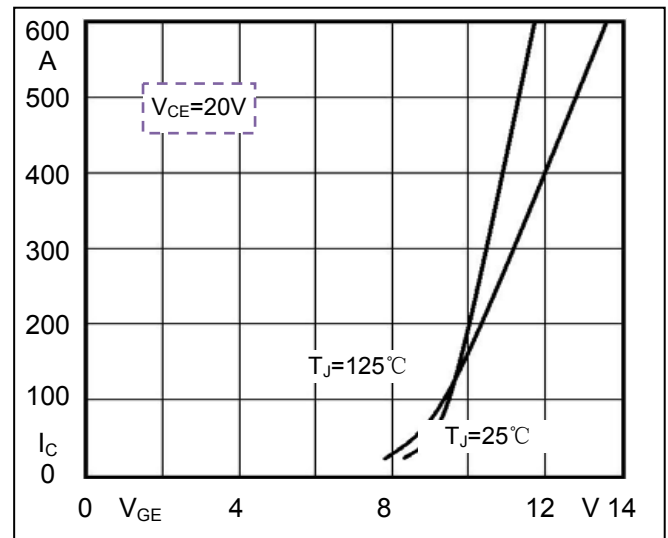

Fig2. Typical Transfer Characteristics

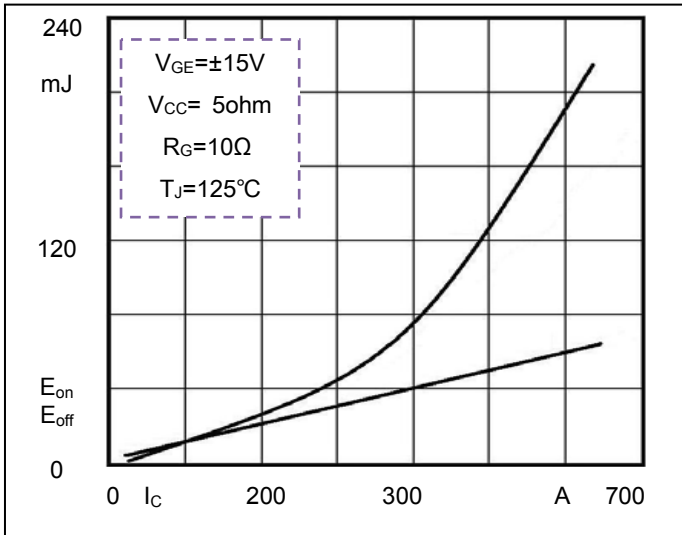

Fig3. Switching Energy vs. Collector Current

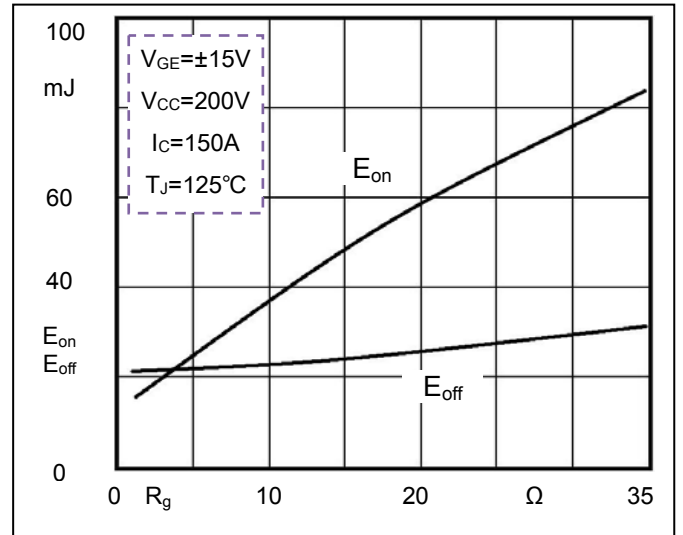

Fig4. Switching Energy vs. Gate Resistor

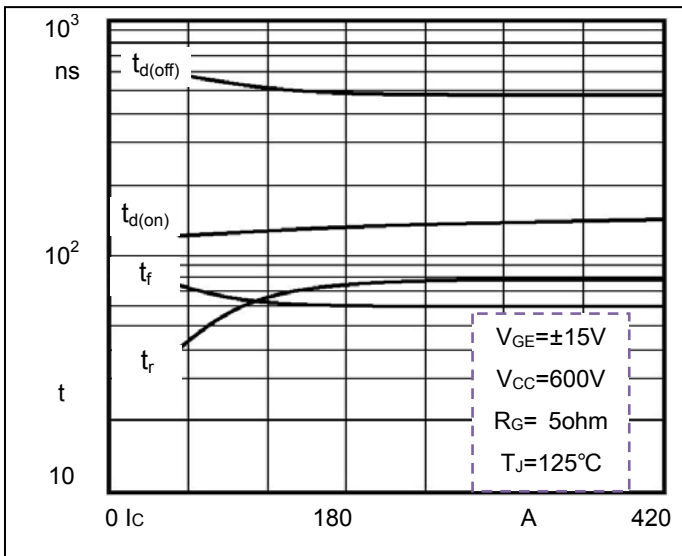

Fig5. Switching Times vs. Collector Current

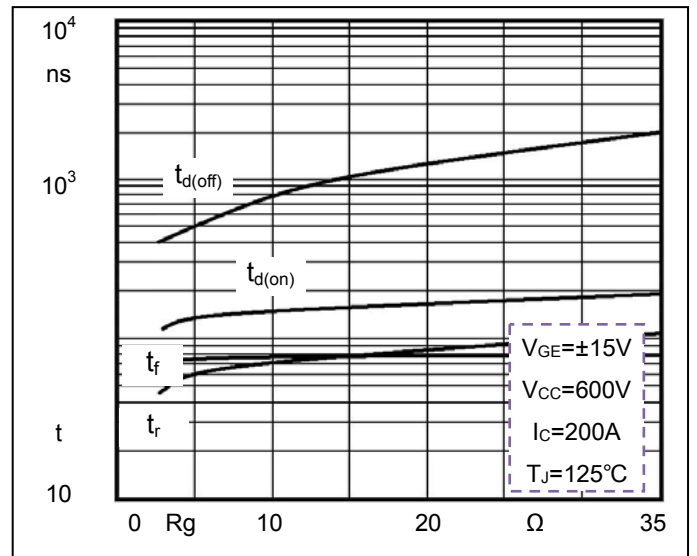

Fig6. Switching Times vs. Gate Resistor

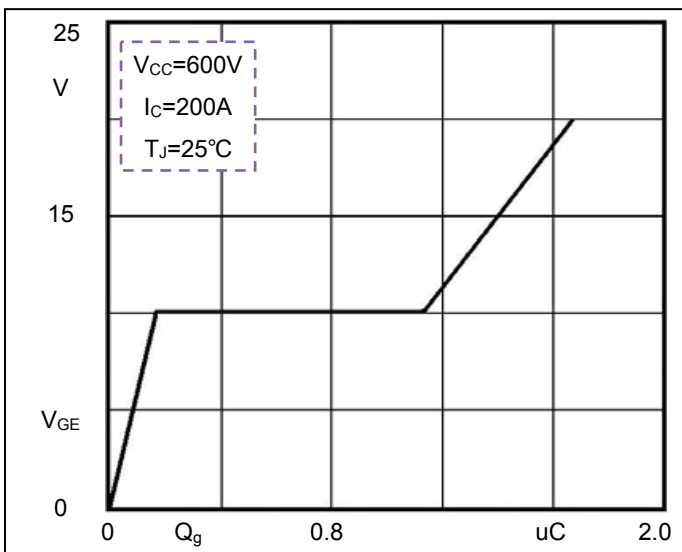

Fig7. Gate Charge characteristics

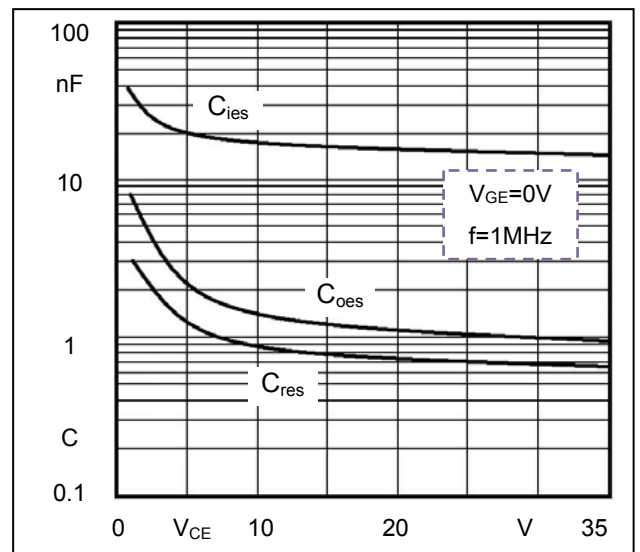

Fig8. Typical Capacitances vs.  $V_{CE}$

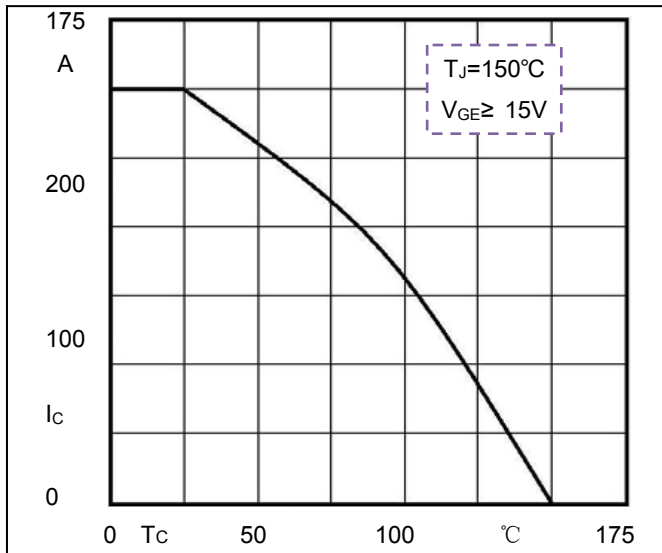

Fig9. Rated Current vs.  $T_c$

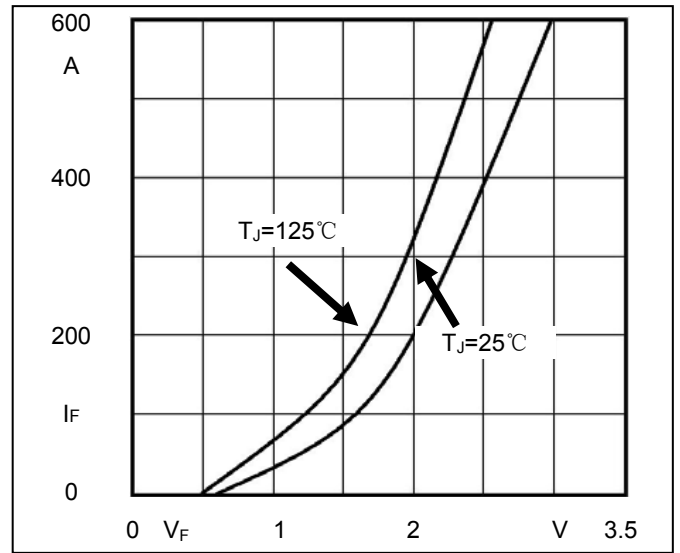

Fig10. Diode Forward Characteristics

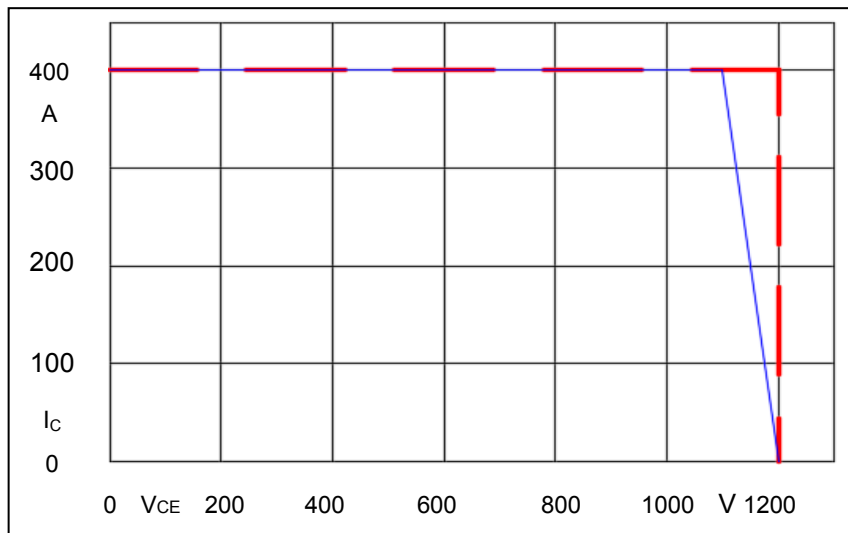

Fig11. Reverse Bias Safe Operation Area (RBSOA)

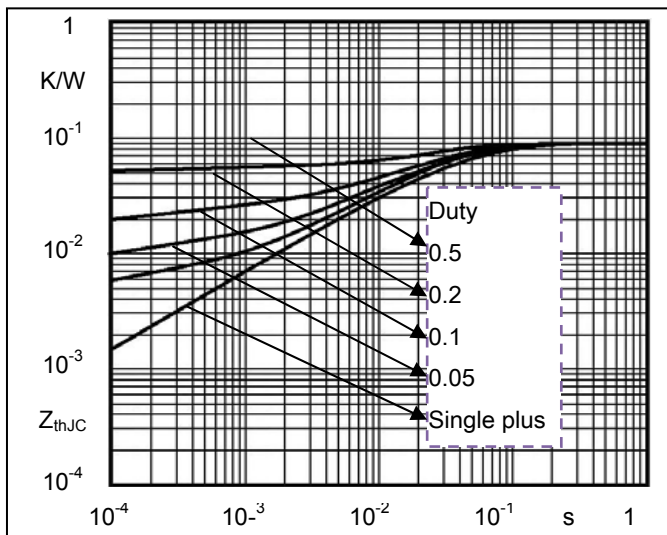

Fig12. Transient Thermal Impedance of IGBT

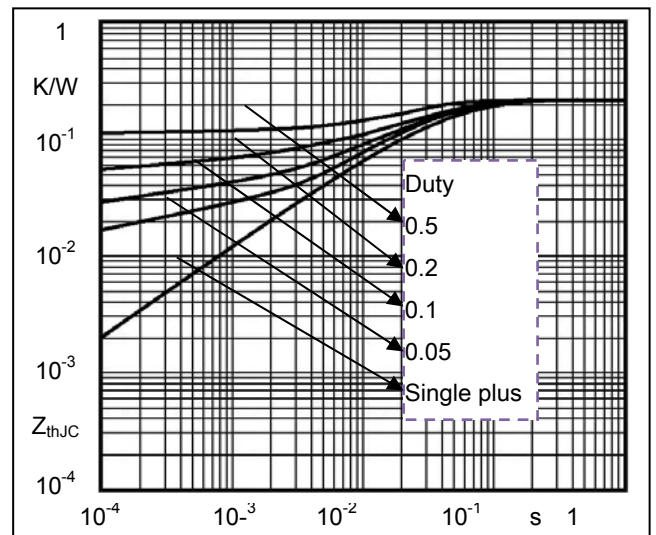
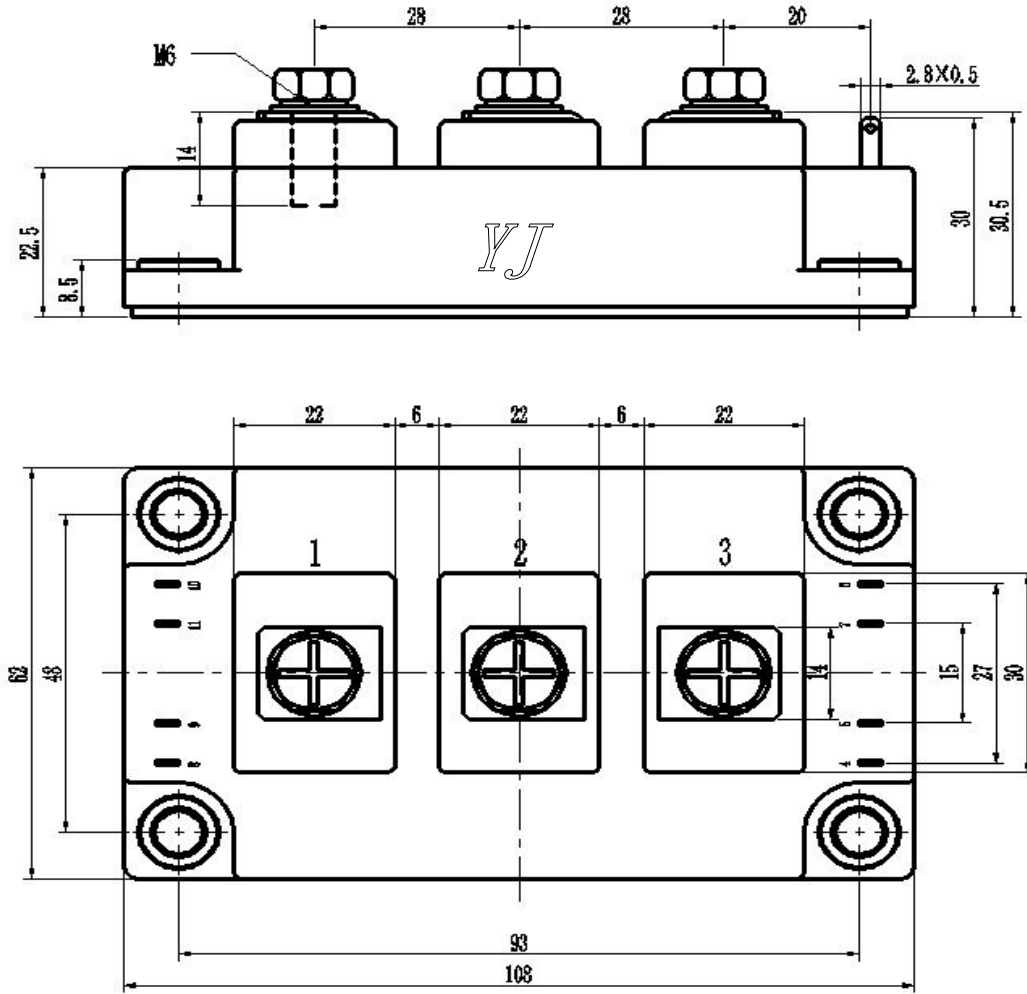

Fig13. Transient Thermal Impedance of Diode

## Package Outline Information

CASE: C2



Dimensions in mm