

IGBT Modules



V_{RRM} 1200V

I_{FAV} 100 A

Applications

- Inverter
- Uninterruptible Power Supply (UPS)
- Converter
- Welder
- SMPS
- Converter

Features

- Ultra Low Loss
- Positive Temperature Coefficient
- High Ruggedness
- Fully isolated package
- High Short Circuit Capability
- Popular SOT-227 Package

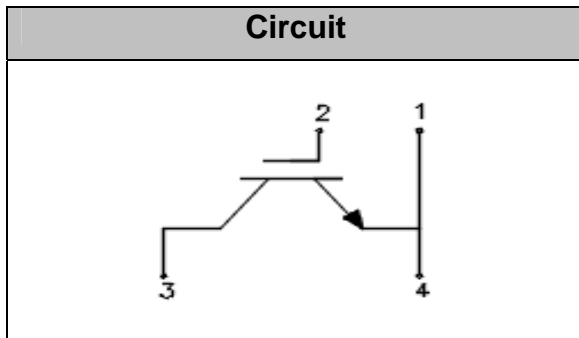

Absolute Maximum Ratings (T_c = 25°C unless otherwise specified)

Symbol	Description	Values	Units
V _{CES}	Collector - Emitter Voltage	1200	V
V _{GES}	Gate-Emitter Voltage	±20	V
I _c	DC Collector Current	T _c =25°C	150 A
		T _c =80°C	100 A
I _{CM}	Pulsed collector current	T _J = 80°C	200 A
P _D	Maximum Power Dissipation (IGBT)	T _c = 25°C, T _{Jmax} =150°C	690 W
T _J	Maximum Junction Temperature		150 °C
T _{JOP}	Operating Temperature		-40 ~ +150 °C
T _{stg}	Storage Temperature		-40 ~ +125 °C
Visol	Isolation Voltage (All Terminals Shorted)	f=50Hz, 1min	3000 V
Weight	Weight Of Module		27 g
Mounting Torque	Module-to-Sink:M4		1.2 N*m
	Module Electrodes:M4		1.1 N*m



Electrical Characteristics of IGBT (T_J = 25°C unless otherwise specified)

Symbol	Item	Conditions	Values			Units
			Min.	Typ.	Max.	
OFF Characteristics						
V _{(BR)CES}	Collector-Emitter Breakdown Voltage	V _{GE} = 0V, I _C = 1mA	1200			V
I _{CES}	Collector Leakage Current	V _{CE} =V _{CES} , V _{GE} =0V,			300	uA
		V _{CE} =V _{CES} , V _{GE} =0V, T _J =125°C			3	mA
I _{GES}	Gate Leakage Current	V _{CE} =0V, V _{GE} =±20V	-200		200	nA
ON Characteristics						
V _{GE(th)}	Gate - Emitter Threshold Voltage	V _{CE} =V _{GE} , I _C =1mA	5	5.5	6.5	V
V _{CE(sat)}	Collector – Emitter Saturation Voltage	I _C =100A, V _{GE} =15V		1.9		V
		I _C =100A, V _{GE} =15V, T _J =125°C		2.3		V
Dynamic Characteristics						
C _{ies}	Input Capacitance	V _{CE} = 25V, V _{GE} = 0V , f = 1MHz		7.43		nF
C _{oes}	Output Capacitance			0.52		nF
Switching Characteristics						
t _{d(on)}	Turn-on Delay Time	V _{CC} = 600V, I _C = 100A , R _G = 15Ω, V _{GE} = ±15V , Inductive Load, T _J = 25°C		125		ns
t _r	Rise Time			60		ns
t _{d(off)}	Turn-off Delay Time			420		ns
T _f	Fall Time			60		ns
E _{on}	Turn-on Switching Loss			6.6		mJ
E _{off}	Turn-off Switching Loss			6.8		mJ
t _{d(on)}	Turn-on Delay Time	V _{CC} = 600V, I _C = 100A , R _G = 15Ω, V _{GE} = ±15V , Inductive Load, T _J = 125°C		135		ns
t _r	Rise Time			60		ns
t _{d(off)}	Turn-off Delay Time			490		ns
T _f	Fall Time			75		ns
E _{on}	Turn-on Switching Loss			12.4		mJ
E _{off}	Turn-off Switching Loss			10.8		mJ
Q _{ge}	Gate Charge	V _{CC} =600V, I _C =100A, V _{GE} =±15V		1050		nC
RBSOA	Reverse Bias Safe Operating Area	I _C = 200A , V _{CC} = 600V, V _p =1200V, R _g = 22Ω, V _{GE} =+15V to 0V, L=500uH, T _J =150°C	Trapezoid			
SCSOA	Short Circuit Safe Operating Area	V _{CC} = 600V, V _{GE} = 15V, T _J = 150°C	10			μs



Thermal Resistance Characteristics

Symbol	Description	Min.	Typ.	Max.	Units
$R_{\theta JC}$	Junction-To-Case (IGBT Part, Per Leg)			0.18	$^{\circ}\text{C}/\text{W}$
$R_{\theta CS}$	Case-To-Sink (Conductive Grease Applied)		0.05		$^{\circ}\text{C}/\text{W}$

Performance Curves

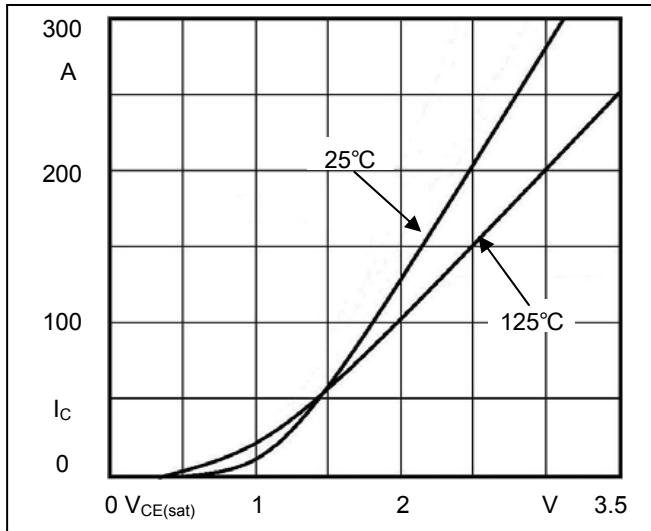

Fig1. Typical Output characteristics

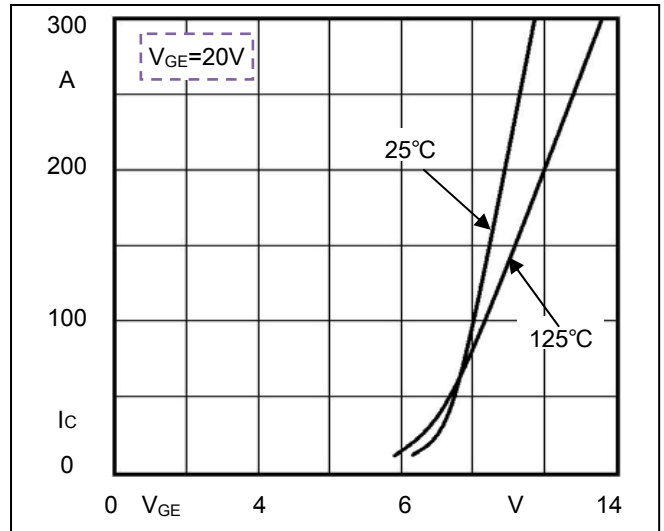

Fig2. Typical Transfer characteristics

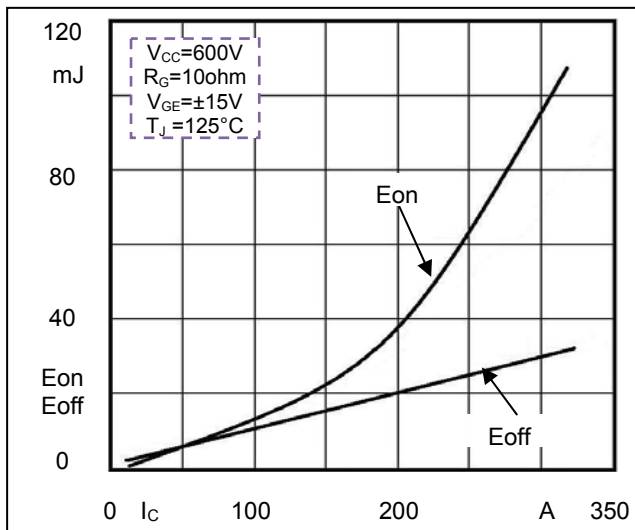

Fig3. Switching Energy vs. Collector Current

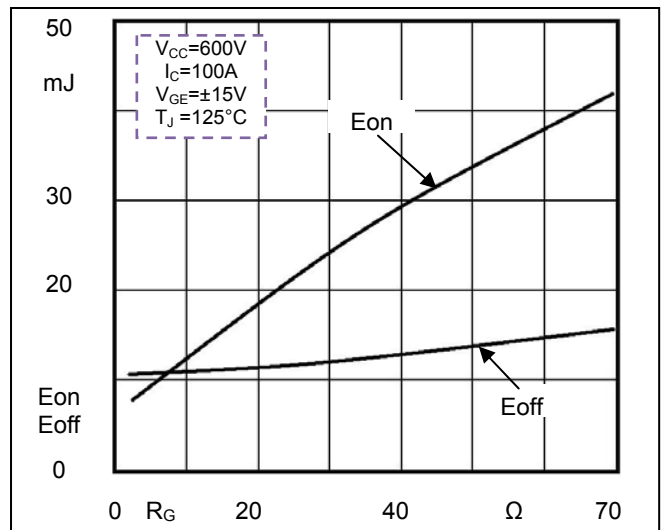

Fig4. Switching Energy vs. Gate Resistor

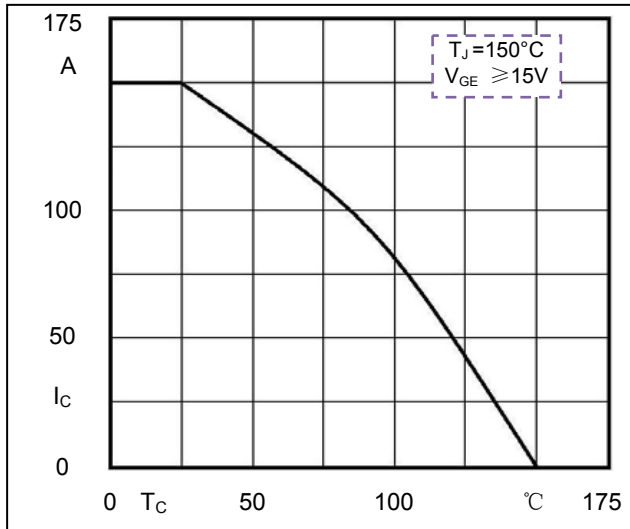

Fig5. Rated Current vs. TC

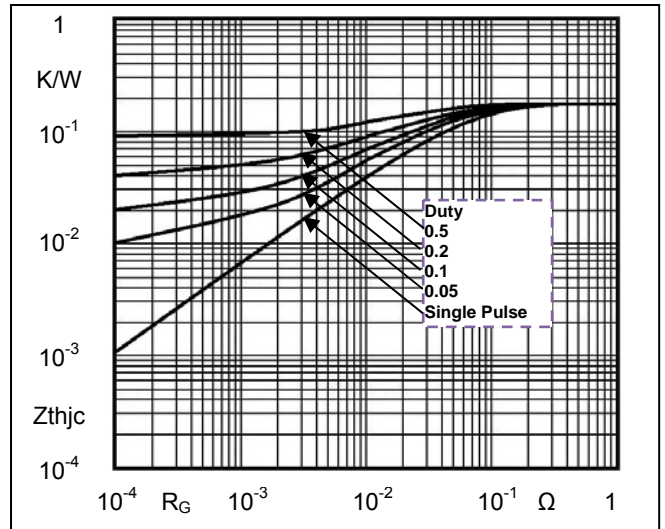

Fig6. Transient Thermal Impedance

Package Outline Information

