

## FRED Modules

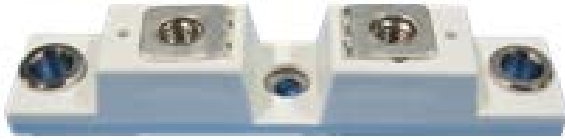

**V<sub>RRM</sub>** 400V  
**I<sub>FAV</sub>** 200 A

### Features

- Soft Reverse Recovery Characteristics
- Ultrafast Reverse Recovery Time
- Low Reverse Recovery Loss
- Low Forward Voltage
- High Surge Current Capability
- Low Inductance Package

### Applications

- Inversion Welder
- Uninterruptible Power Supply (UPS)
- Plating Power Supply
- Ultrasonic Cleaner and Welder
- Power Factor Correction (PFC) Circuit
- Converter & Chopper

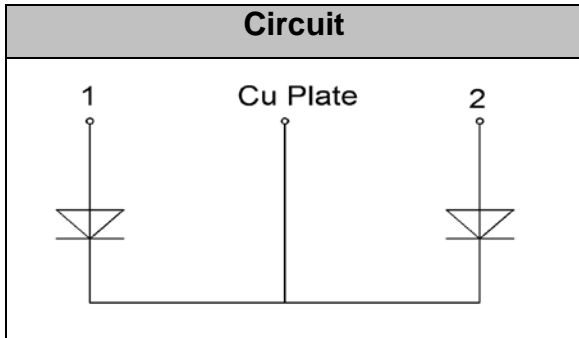

### Maximum Ratings

Symbol	Conditions	Values	Units
$V_R$		400	V
$V_{RRM}$		400	V
$I_{F(AV)}$	$T_C=125^\circ\text{C}$ , Per Diode	100	A
	$T_C=125^\circ\text{C}$ , Per Module	200	A
$I_{F(RMS)}$	$T_C=125^\circ\text{C}$ , Per Diode	150	A
$I_{FSM}$	1/2 Cycle, 50Hz, Sine	1500	A
	1/2 Cycle, 60Hz, Sine	1800	A
$I^2t$	$T_J=45^\circ\text{C}$ , $t=10\text{ms}$ , 50Hz, Sine	11250	$\text{A}^2\text{s}$
	$T_J=45^\circ\text{C}$ , $t=8.3\text{ms}$ , 60Hz, Sine	16200	$\text{A}^2\text{s}$
$P_D$		833	W
$T_J$		-40 to +150	$^\circ\text{C}$
$T_{STG}$		-40 to +125	$^\circ\text{C}$
Torque	Recommended (M6)	3~4.7	N·m
Torque	Recommended (M6)	3~4.7	N·m
Weight		68	g

### Thermal Characteristics

Symbol	Conditions	Values	Units
$R_{th(j-c)}$	Per diode	0.15	$^\circ\text{C/W}$



**Electrical Characteristics**

Symbol	Conditions	Values			Units
		Min.	Typ.	Max.	
$I_{RM}$	$V_R=400V$	--	--	0.5	mA
	$V_R=400V, T_J=125^\circ C$	--	--	1	mA
$V_F$	$I_F=100A$	--	1.1	1.35	V
	$I_F=100A, T_J=125^\circ C$	--	1.0	1.25	V
trr	$I_F=1A, V_R=30V, di_F/dt=-200A/\mu s$	--	38	--	ns
trr	$V_R=200V, I_F=100A, di_F/dt=-200A/\mu s, T_J=25^\circ C$	--	95	--	ns
$I_{RRM}$		--	8.5	--	A
trr	$V_R=200V, I_F=100A, di_F/dt=-200A/\mu s, T_J=125^\circ C$	--	150	--	ns
$I_{RRM}$		--	14	--	A

**Performance Curves**

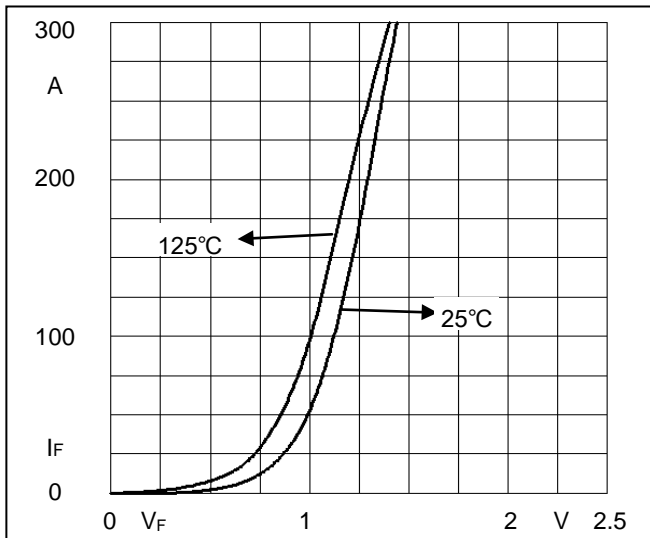

**Fig1. Forward Voltage Drop vs Forward Current**

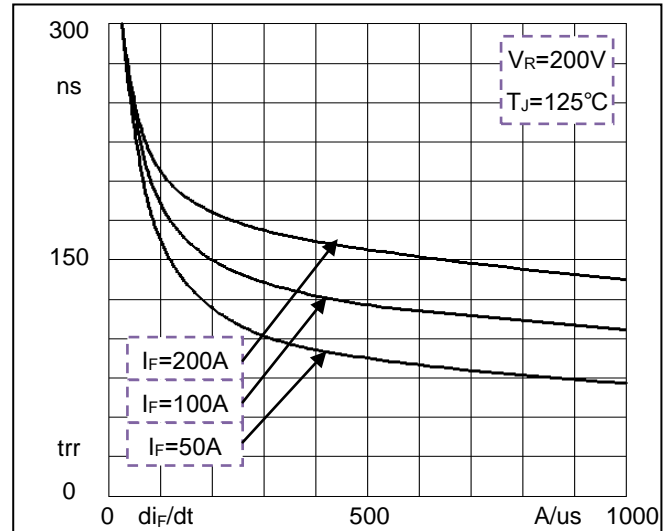

**Fig2. Reverse Recovery Time vs  $di_F/dt$**

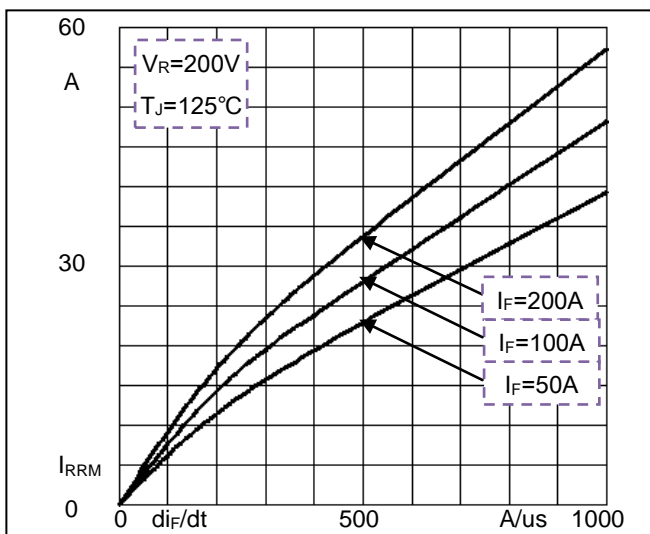

**Fig3. Reverse Recovery Current vs  $di_F/dt$**

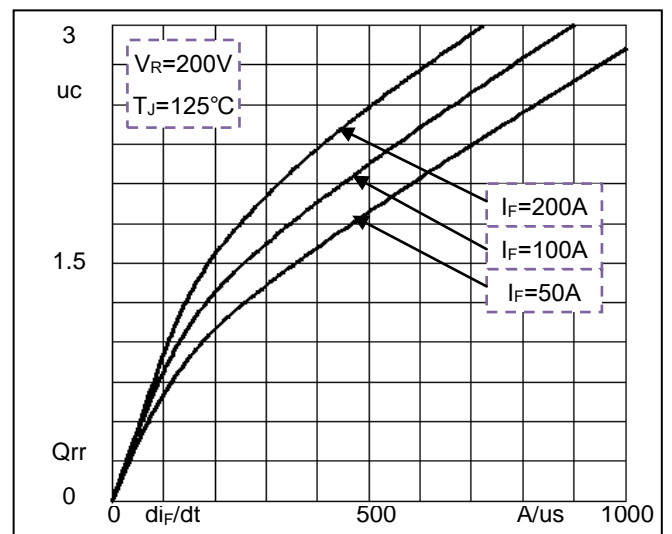

**Fig4. Reverse Recovery Charge vs  $di_F/dt$**

**Package Outline Information**

**CASE: F4N**

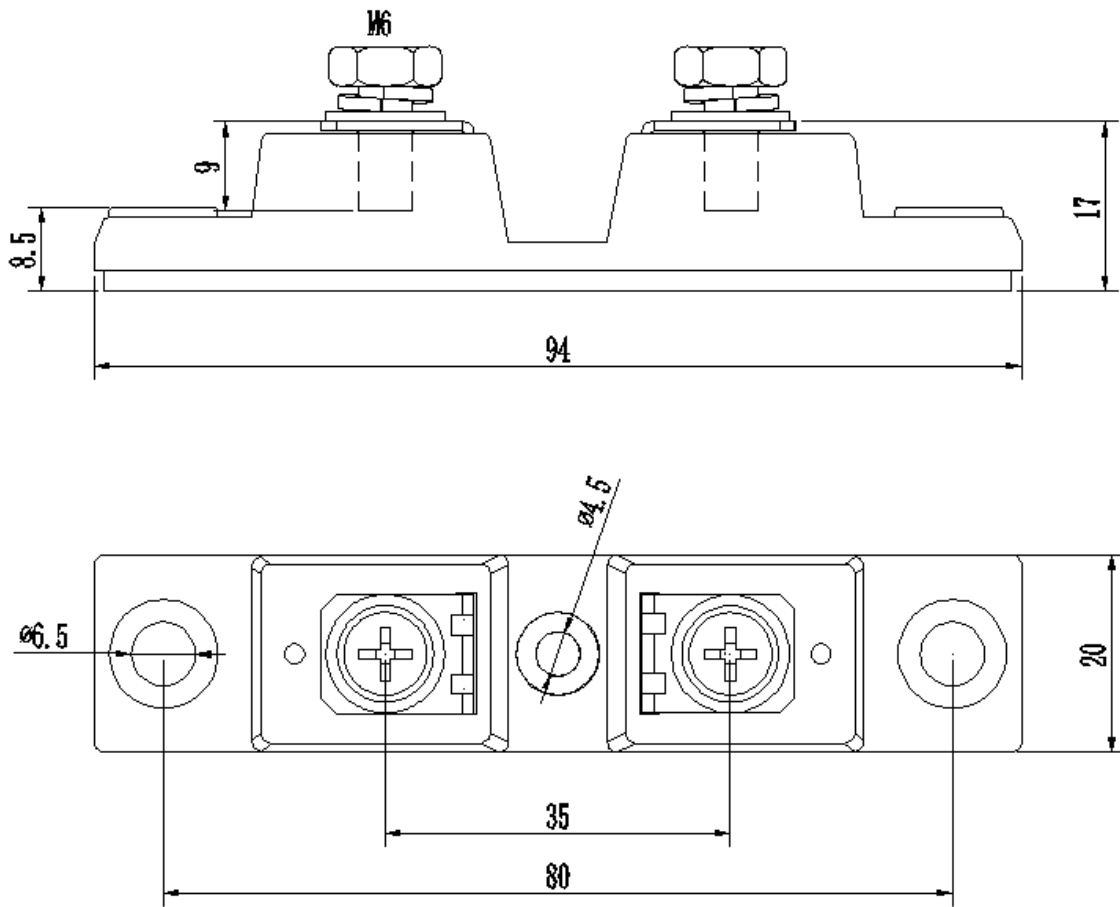

**Dimensions in mm**