

## Standard Rectifier Module

$$V_{RRM} = 2 \times 1200 \text{ V}$$

$$I_{FAV} = 85 \text{ A}$$

$$V_F = 1.1 \text{ V}$$

Phase leg

Part number

**MDMA85P1200TG**

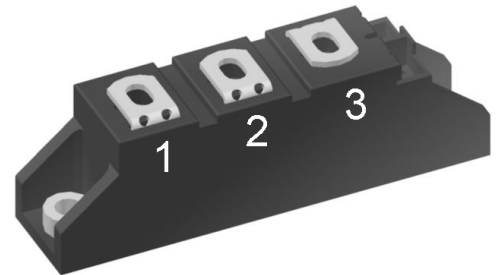

Backside: isolated

 E72873

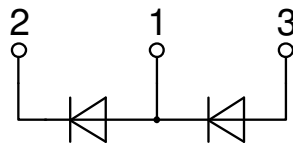

### Features / Advantages:

- Package with DCB ceramic
- Improved temperature and power cycling
- Planar passivated chips
- Very low forward voltage drop
- Very low leakage current

### Applications:

- Diode for main rectification
- For single and three phase bridge configurations
- Supplies for DC power equipment
- Input rectifiers for PWM inverter
- Battery DC power supplies
- Field supply for DC motors

### Package: TO-240AA

- Isolation Voltage: 4800 V~
- Industry standard outline
- RoHS compliant
- Height: 30 mm
- Base plate: DCB ceramic
- Reduced weight
- Advanced power cycling

### Terms Conditions of usage:

The data contained in this product data sheet is exclusively intended for technically trained staff. The user will have to evaluate the suitability of the product for the intended application and the completeness of the product data with respect to his application. The specifications of our components may not be considered as an assurance of component characteristics. The information in the valid application- and assembly notes must be considered. Should you require product information in excess of the data given in this product data sheet or which concerns the specific application of your product, please contact your local sales office.

Due to technical requirements our product may contain dangerous substances. For information on the types in question please contact your local sales office.

Should you intend to use the product in aviation, in health or life endangering or life support applications, please notify. For any such application we urgently recommend

- to perform joint risk and quality assessments;

- the conclusion of quality agreements;

- to establish joint measures of an ongoing product survey, and that we may make delivery dependent on the realization of any such measures.

Rectifier				Ratings			
Symbol	Definition	Conditions		min.	typ.	max.	Unit
$V_{RSM}$	max. non-repetitive reverse blocking voltage					1300	V
$V_{RRM}$	max. repetitive reverse blocking voltage					1200	V
$I_R$	reverse current	$V_R = 1200$ V		$T_{VJ} = 25^\circ\text{C}$		100	$\mu\text{A}$
		$V_R = 1200$ V		$T_{VJ} = 150^\circ\text{C}$		2	mA
$V_F$	forward voltage drop	$I_F = 85$ A		$T_{VJ} = 25^\circ\text{C}$		1.15	V
		$I_F = 170$ A				1.38	V
		$I_F = 85$ A		$T_{VJ} = 125^\circ\text{C}$		1.10	V
		$I_F = 170$ A				1.39	V
$I_{FAV}$	average forward current	$T_C = 100^\circ\text{C}$		$T_{VJ} = 150^\circ\text{C}$		85	A
		rectangular	d = 0.5				
$V_{FO}$	threshold voltage			$T_{VJ} = 150^\circ\text{C}$		0.79	V
$r_F$	slope resistance					3.5	m $\Omega$
						} for power loss calculation only	
$R_{thJC}$	thermal resistance junction to case					0.35	K/W
$R_{thCH}$	thermal resistance case to heatsink				0.20		K/W
$P_{tot}$	total power dissipation			$T_C = 25^\circ\text{C}$		350	W
$I_{FSM}$	max. forward surge current	t = 10 ms; (50 Hz), sine		$T_{VJ} = 45^\circ\text{C}$		1.50	kA
		t = 8,3 ms; (60 Hz), sine		$V_R = 0$ V		1.62	kA
		t = 10 ms; (50 Hz), sine		$T_{VJ} = 150^\circ\text{C}$		1.28	kA
		t = 8,3 ms; (60 Hz), sine		$V_R = 0$ V		1.38	kA
$I^2t$	value for fusing	t = 10 ms; (50 Hz), sine		$T_{VJ} = 45^\circ\text{C}$		11.3	kA <sup>2</sup> s
		t = 8,3 ms; (60 Hz), sine		$V_R = 0$ V		10.9	kA <sup>2</sup> s
		t = 10 ms; (50 Hz), sine		$T_{VJ} = 150^\circ\text{C}$		8.13	kA <sup>2</sup> s
		t = 8,3 ms; (60 Hz), sine		$V_R = 0$ V		7.87	kA <sup>2</sup> s
$C_J$	junction capacitance	$V_R = 400$ V; f = 1 MHz		$T_{VJ} = 25^\circ\text{C}$		60	pF

Package TO-240AA				Ratings			
Symbol	Definition	Conditions	min.	typ.	max.	Unit	
$I_{RMS}$	RMS current	per terminal			200	A	
$T_{VJ}$	virtual junction temperature		-40		150	°C	
$T_{op}$	operation temperature		-40		125	°C	
$T_{stg}$	storage temperature		-40		125	°C	
<b>Weight</b>					76	g	
$M_D$	mounting torque		2.5		4	Nm	
$M_T$	terminal torque		2.5		4	Nm	
$d_{Spp/App}$	creepage distance on surface   striking distance through air	terminal to terminal	13.0	9.7		mm	
$d_{Spb/Apb}$		terminal to backside	16.0	16.0		mm	
$V_{ISOL}$	isolation voltage	t = 1 second		4800		V	
		t = 1 minute	50/60 Hz, RMS; $I_{ISOL} \leq 1$ mA	4000		V	

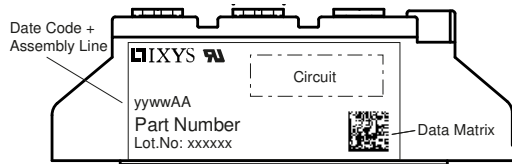

### Part description

- M = Module
- D = Diode
- M = Standard Rectifier
- A = (up to 1800V)
- 85 = Current Rating [A]
- P = Phase leg
- 1200 = Reverse Voltage [V]
- TG = TO-240AA

Ordering	Ordering Number	Marking on Product	Delivery Mode	Quantity	Code No.
Standard	MDMA85P1200TG	MDMA85P1200TG	Box	36	513015

### Equivalent Circuits for Simulation

\* on die level

$T_{VJ} = 150^\circ\text{C}$

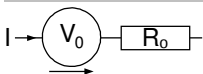

Rectifier

$V_{0\ max}$	threshold voltage	0.79	V
$R_{0\ max}$	slope resistance *	2.3	mΩ

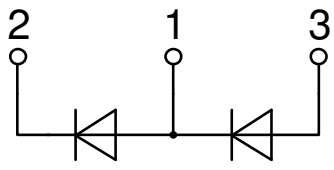
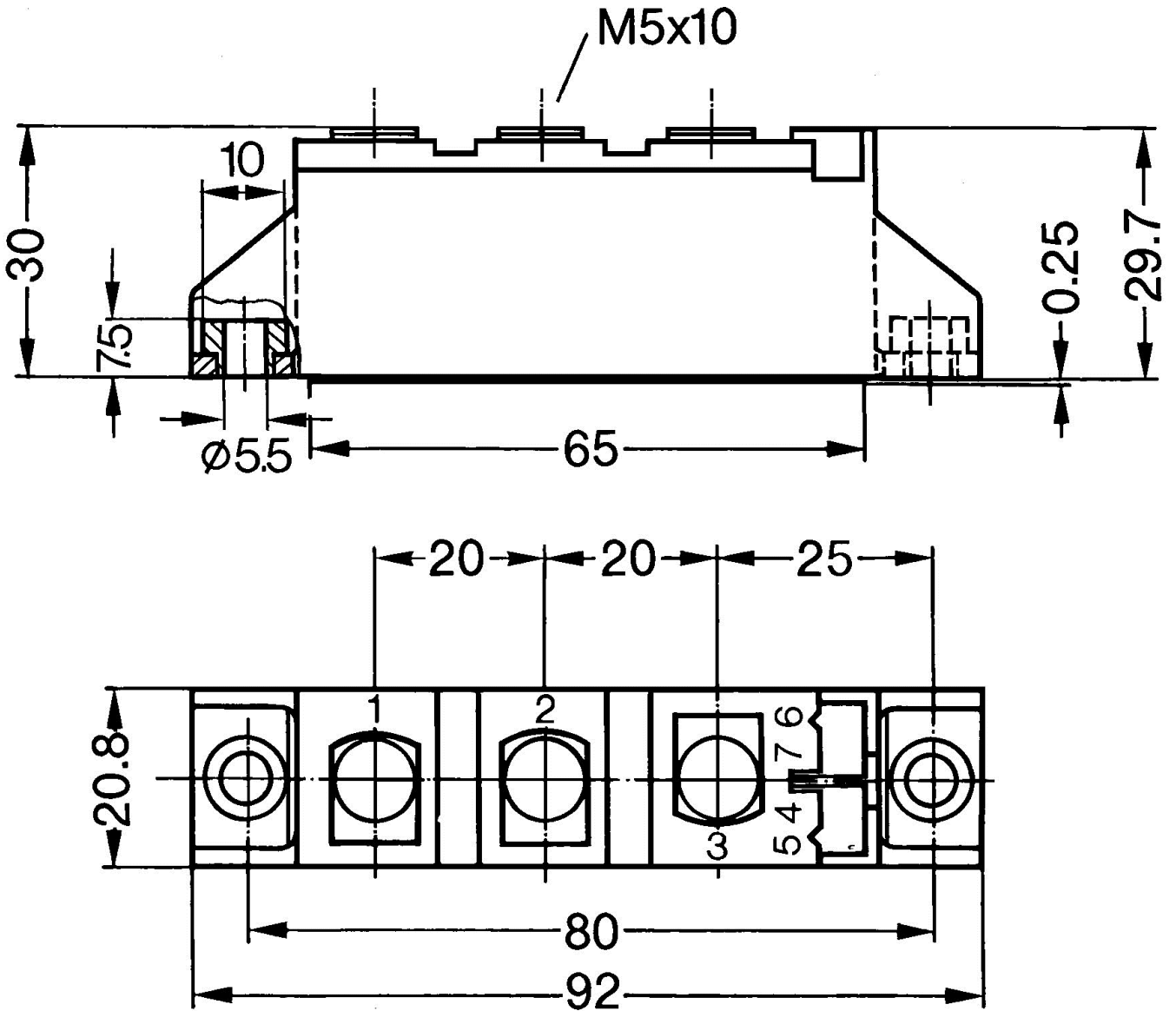

**Rectifier**

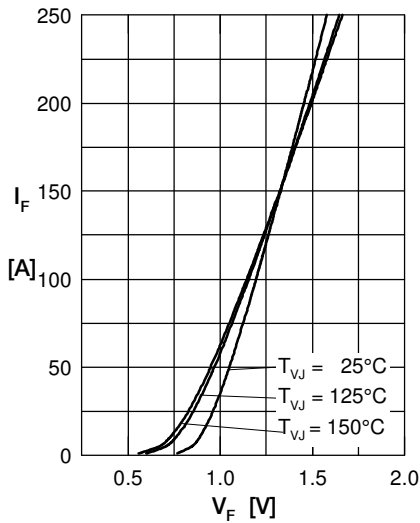

Fig. 1 Forward current versus voltage drop per diode

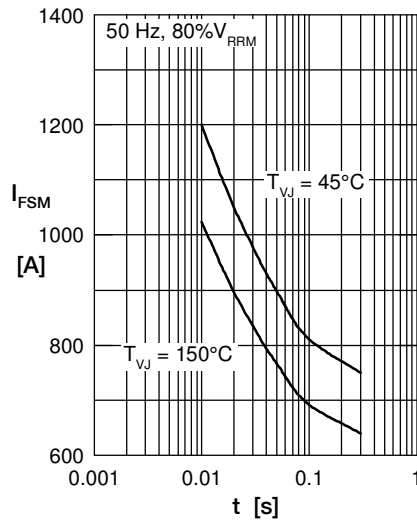

Fig. 2 Surge overload current vs. time per diode

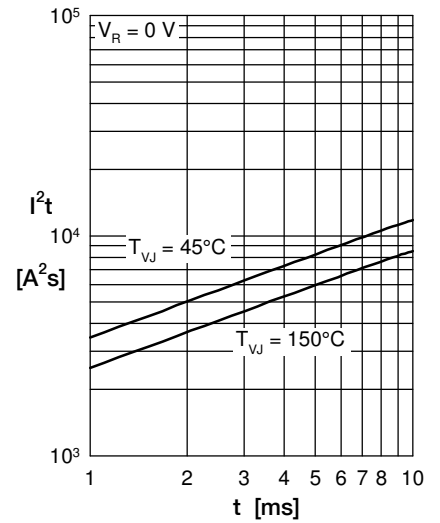

Fig. 3  $I^2t$  versus time per diode

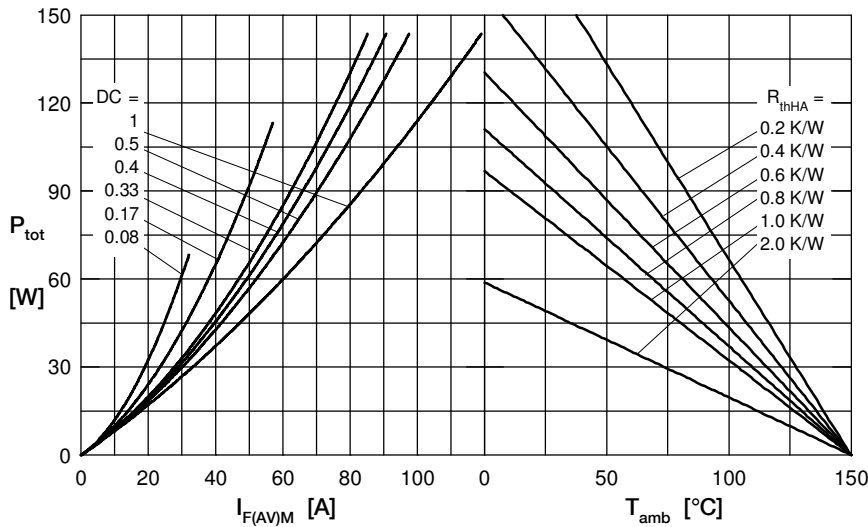

Fig. 4 Power dissipation vs. forward current and ambient temperature per diode

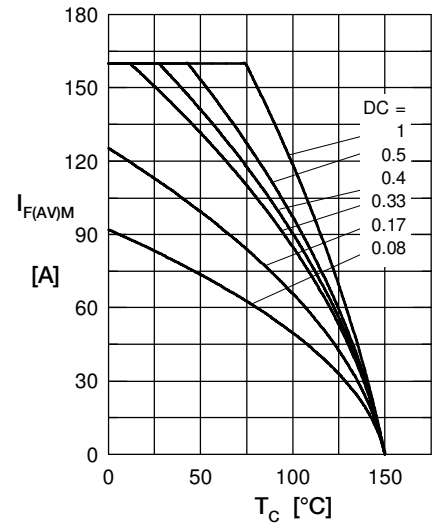

Fig. 5 Max. forward current vs. case temperature per diode

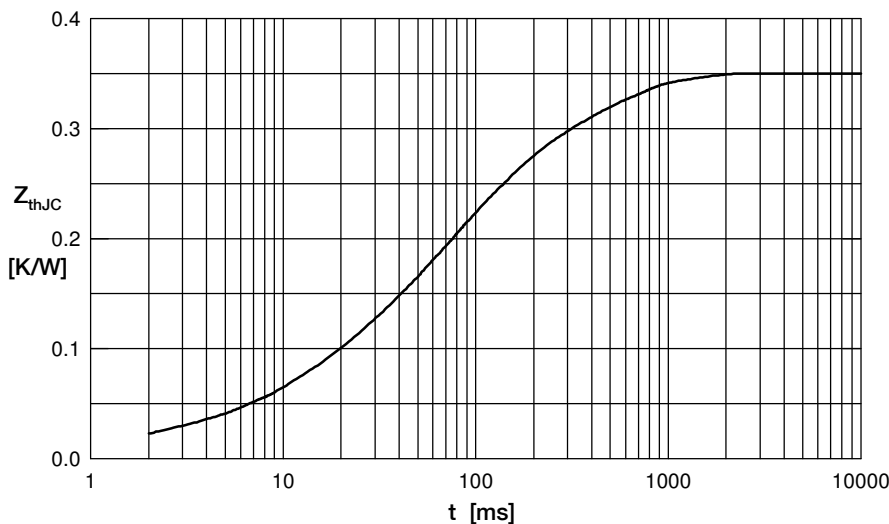

Fig. 6 Transient thermal impedance junction to case vs. time per diode

Constants for  $Z_{thJC}$  calculation:

i	$R_{thi}$ (K/W)	$t_i$ (s)
1	0.012	0.001
2	0.048	0.013
3	0.185	0.070
4	0.105	0.400