

## Standard Rectifier

$$V_{RRM} = 800V$$

$$I_{FAV} = 45A$$

$$V_F = 1.23V$$

## Single Diode

Part number

DSI45-08A

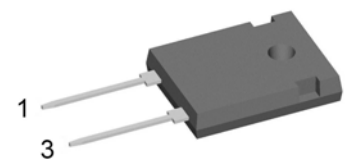

Backside: cathode

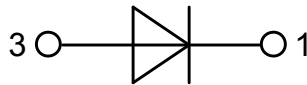

### Features / Advantages:

- Planar passivated chips
- Very low leakage current
- Very low forward voltage drop
- Improved thermal behaviour

### Applications:

- Diode for main rectification
- For single and three phase bridge configurations

### Package: TO-247

- Industry standard outline
- RoHS compliant
- Epoxy meets UL 94V-0

| Rectifier  |  |   |      | Ratings |      |                   |
|------------|--|---|------|---------|------|-------------------|
| Symbol     | Definition                                   | Conditions  | min. | typ.    | max. | Unit              |
| $V_{RSM}$  | max. non-repetitive reverse blocking voltage |   |      |         | 900  | V                 |
| $V_{RRM}$  | max. repetitive reverse blocking voltage     |   |      |         | 800  | V                 |
| $I_R$      | reverse current, drain current               | $V_R = 800\text{ V}$                              |      |         | 40   | $\mu\text{A}$     |
|            |  | $V_R = 800\text{ V}$                              |      |         | 1.5  | mA                |
| $V_F$      | forward voltage drop                         | $I_F = 45\text{ A}$                               |      |         | 1.26 | V                 |
|            |  | $I_F = 90\text{ A}$                               |      |         | 1.57 | V                 |
|            |  | $I_F = 45\text{ A}$                               |      |         | 1.23 | V                 |
|            |  | $I_F = 90\text{ A}$                               |      |         | 1.66 | V                 |
| $I_{FAV}$  | average forward current                      | $T_C = 130^\circ\text{C}$                         |      |         | 45   | A                 |
|            |  | 180° sine   |      |         |      |                   |
| $V_{FO}$   | threshold voltage                            | } for power loss calculation only                 |      |         | 0.81 | V                 |
| $r_F$      | slope resistance                             |   |      |         | 9.1  | m $\Omega$        |
| $R_{thJC}$ | thermal resistance junction to case          |   |      |         | 0.55 | K/W               |
| $R_{thCH}$ | thermal resistance case to heatsink          |   |      | 0.25    |      | K/W               |
| $P_{tot}$  | total power dissipation                      |   |      |         | 270  | W                 |
| $I_{FSM}$  | max. forward surge current                   | $t = 10\text{ ms}; (50\text{ Hz}), \text{ sine}$  |      |         | 480  | A                 |
|            |  | $t = 8,3\text{ ms}; (60\text{ Hz}), \text{ sine}$ |      |         | 520  | A                 |
|            |  | $t = 10\text{ ms}; (50\text{ Hz}), \text{ sine}$  |      |         | 410  | A                 |
|            |  | $t = 8,3\text{ ms}; (60\text{ Hz}), \text{ sine}$ |      |         | 440  | A                 |
| $I^2t$     | value for fusing                             | $t = 10\text{ ms}; (50\text{ Hz}), \text{ sine}$  |      |         | 1.15 | kA <sup>2</sup> s |
|            |  | $t = 8,3\text{ ms}; (60\text{ Hz}), \text{ sine}$ |      |         | 1.13 | kA <sup>2</sup> s |
|            |  | $t = 10\text{ ms}; (50\text{ Hz}), \text{ sine}$  |      |         | 840  | A <sup>2</sup> s  |
|            |  | $t = 8,3\text{ ms}; (60\text{ Hz}), \text{ sine}$ |      |         | 805  | A <sup>2</sup> s  |
| $C_J$      | junction capacitance                         | $V_R = 400\text{ V}; f = 1\text{ MHz}$            |      |         | 18   | pF                |

| Package TO-247 |                              |              | Ratings |      |      |      |
|----------------|------------------------------|--------------|---------|------|------|------|
| Symbol         | Definition                   | Conditions   | min.    | typ. | max. | Unit |
| $I_{RMS}$      | RMS current                  | per terminal |         |      | 70   | A    |
| $T_{stg}$      | storage temperature          |              | -55     |      | 150  | °C   |
| $T_{vj}$       | virtual junction temperature |              | -40     |      | 175  | °C   |
| <b>Weight</b>  |                              |              |         | 6    |      | g    |
| $M_D$          | mounting torque              |              | 0.8     |      | 1.2  | Nm   |
| $F_C$          | mounting force with clip     |              | 20      |      | 120  | N    |

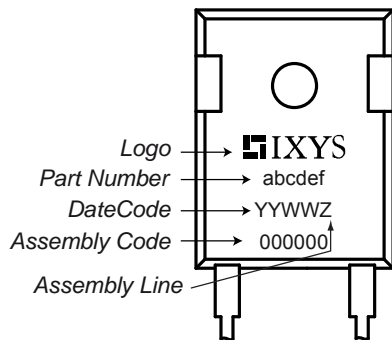
**Product Marking**

| Ordering | Part Number | Marking on Product | Delivery Mode | Quantity | Code No. |
|----------|-------------|--------------------|---------------|----------|----------|
| Standard | DSI45-08A   | DSI45-08A          | Tube          | 30       | 471887   |

| Similar Part | Package        | Voltage class |
|--------------|----------------|---------------|
| DSI45-12A    | TO-247AD (2)   | 1200          |
| DSI45-16A    | TO-247AD (2)   | 1600          |
| DSI45-16AR   | ISOPLUS247 (2) | 1600          |

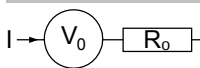
**Equivalent Circuits for Simulation**
*\* on die level*
 $T_{vj} = 175^{\circ}\text{C}$ 

**Rectifier**

|              |                    |      |    |
|--------------|--------------------|------|----|
| $V_{0\ max}$ | threshold voltage  | 0.81 | V  |
| $R_{0\ max}$ | slope resistance * | 6.5  | mΩ |

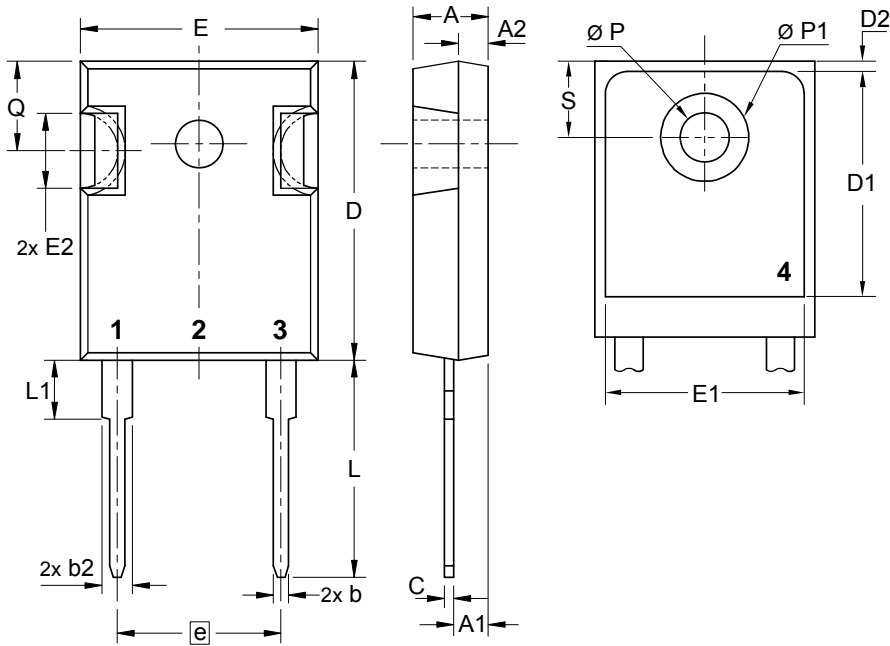
**Outlines TO-247**



| Sym. | Inches    |       | Millimeter |       |
|------|-----------|-------|------------|-------|
|      | min.      | max.  | min.       | max.  |
| A    | 0.185     | 0.209 | 4.70       | 5.30  |
| A1   | 0.087     | 0.102 | 2.21       | 2.59  |
| A2   | 0.059     | 0.098 | 1.50       | 2.49  |
| D    | 0.819     | 0.845 | 20.79      | 21.45 |
| E    | 0.610     | 0.640 | 15.48      | 16.24 |
| E2   | 0.170     | 0.216 | 4.31       | 5.48  |
| e    | 0.430 BSC |       | 10.92 BSC  |       |
| L    | 0.780     | 0.800 | 19.80      | 20.30 |
| L1   | -         | 0.177 | -          | 4.49  |
| Ø P  | 0.140     | 0.144 | 3.55       | 3.65  |
| Q    | 0.212     | 0.244 | 5.38       | 6.19  |
| S    | 0.242 BSC |       | 6.14 BSC   |       |
| b    | 0.039     | 0.055 | 0.99       | 1.40  |
| b2   | 0.065     | 0.094 | 1.65       | 2.39  |
| b4   | 0.102     | 0.135 | 2.59       | 3.43  |
| c    | 0.015     | 0.035 | 0.38       | 0.89  |
| D1   | 0.515     | -     | 13.07      | -     |
| D2   | 0.020     | 0.053 | 0.51       | 1.35  |
| E1   | 0.530     | -     | 13.45      | -     |
| Ø P1 | -         | 0.29  | -          | 7.39  |



## Rectifier

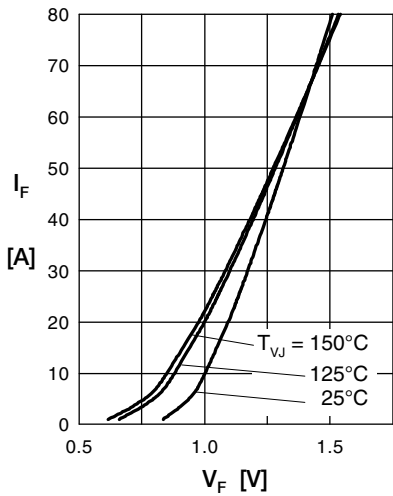

Fig. 1 Forward current versus voltage drop per diode

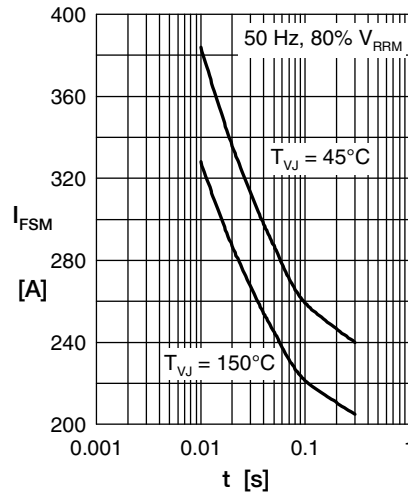

Fig. 2 Surge overload current

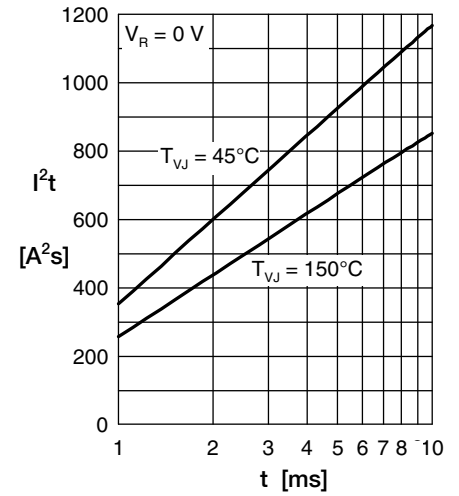

Fig. 3  $I^2t$  versus time per diode

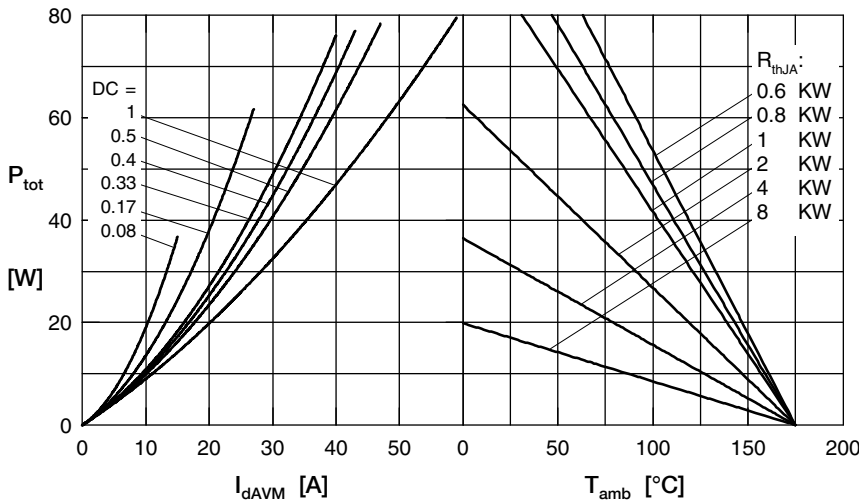

Fig. 4 Power dissipation vs. direct output current & ambient temperature

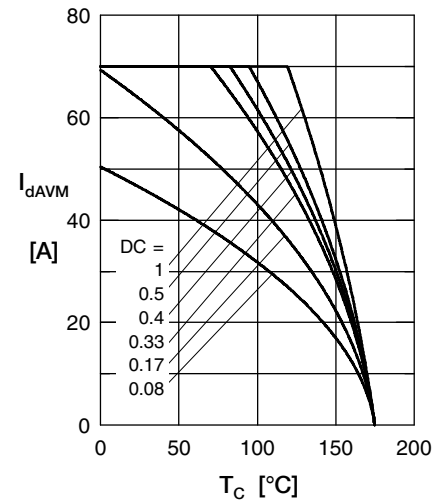

Fig. 5 Max. forward current vs. case temperature

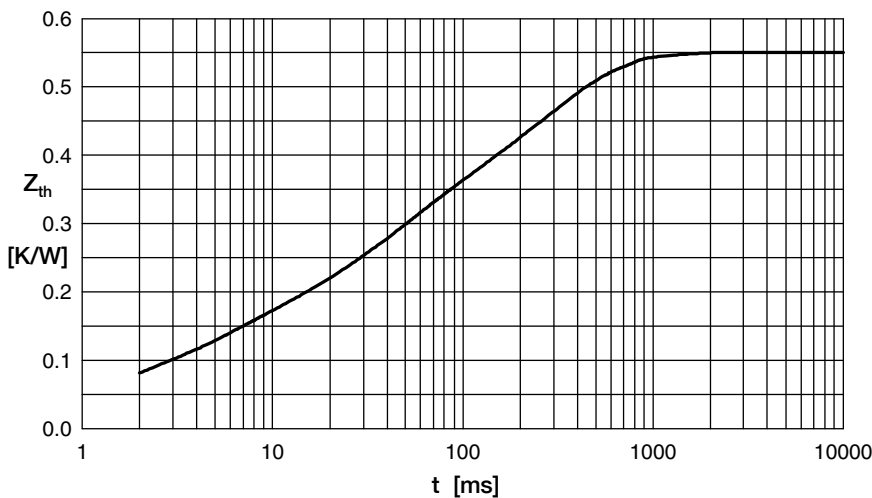

Fig. 6 Transient thermal impedance junction to case

| i | $R_i$ | $t_i$  |
|---|-------|--------|
| 1 | 0.033 | 0.0006 |
| 2 | 0.095 | 0.0039 |
| 3 | 0.164 | 0.033  |
| 4 | 0.258 | 0.272  |