

Standard Rectifier

$$V_{RRM} = 2 \times 1600 \text{ V}$$

$$I_{FAV} = 10 \text{ A}$$

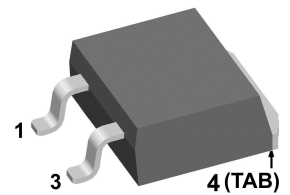
$$V_F = 1.21 \text{ V}$$

Phase leg

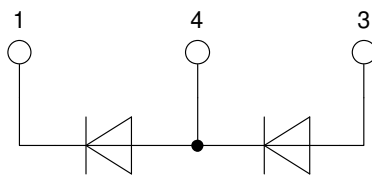
Part number

DMA10P1600PZ

Marking on Product: DMA10P1600PZ



Backside: anode/cathode



Features / Advantages:

- Planar passivated chips
- Very low leakage current
- Very low forward voltage drop
- Improved thermal behaviour

Applications:

- Diode for main rectification
- For single and three phase bridge configurations

Package: TO-263 (D2Pak-HV)

- Industry standard outline
- RoHS compliant
- Epoxy meets UL 94V-0
- High creepage distance between terminals

Disclaimer Notice

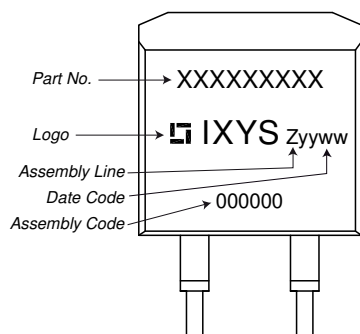
Information furnished is believed to be accurate and reliable. However, users should independently evaluate the suitability of and test each product selected for their own applications. Littelfuse products are not designed for, and may not be used in, all applications. Read complete Disclaimer Notice at www.littelfuse.com/disclaimer-electronics.

| Rectifier | | | | Ratings | | | |
|------------|--|-----------------------------------|-------------|------------------------------|------|------|------------------|
| Symbol | Definition | Conditions | | min. | typ. | max. | Unit |
| V_{RSM} | max. non-repetitive reverse blocking voltage | | | | | 1700 | V |
| V_{RRM} | max. repetitive reverse blocking voltage | | | | | 1600 | V |
| I_R | reverse current | $V_R = 1600$ V | | $T_{VJ} = 25^\circ\text{C}$ | | 10 | μA |
| | | $V_R = 1600$ V | | $T_{VJ} = 150^\circ\text{C}$ | | 0.2 | mA |
| V_F | forward voltage drop | $I_F = 10$ A | | $T_{VJ} = 25^\circ\text{C}$ | | 1.26 | V |
| | | $I_F = 20$ A | | | | 1.53 | V |
| | | $I_F = 10$ A | | $T_{VJ} = 150^\circ\text{C}$ | | 1.21 | V |
| | | $I_F = 20$ A | | | | 1.57 | V |
| I_{FAV} | average forward current | $T_C = 150^\circ\text{C}$ | rectangular | $T_{VJ} = 175^\circ\text{C}$ | | 10 | A |
| V_{FO} | threshold voltage | } for power loss calculation only | | $T_{VJ} = 175^\circ\text{C}$ | | 0.82 | V |
| r_F | slope resistance | | | | | 37 | m Ω |
| R_{thJC} | thermal resistance junction to case | | | | | 1.5 | K/W |
| R_{thCH} | thermal resistance case to heatsink | | | | 0.25 | | K/W |
| P_{tot} | total power dissipation | | | $T_C = 25^\circ\text{C}$ | | 100 | W |
| I_{FSM} | max. forward surge current | $t = 10$ ms; (50 Hz), sine | | $T_{VJ} = 45^\circ\text{C}$ | | 120 | A |
| | | $t = 8,3$ ms; (60 Hz), sine | | $V_R = 0$ V | | 130 | A |
| | | $t = 10$ ms; (50 Hz), sine | | $T_{VJ} = 150^\circ\text{C}$ | | 100 | A |
| | | $t = 8,3$ ms; (60 Hz), sine | | $V_R = 0$ V | | 110 | A |
| I^2t | value for fusing | $t = 10$ ms; (50 Hz), sine | | $T_{VJ} = 45^\circ\text{C}$ | | 72 | A ² s |
| | | $t = 8,3$ ms; (60 Hz), sine | | $V_R = 0$ V | | 70 | A ² s |
| | | $t = 10$ ms; (50 Hz), sine | | $T_{VJ} = 150^\circ\text{C}$ | | 50 | A ² s |
| | | $t = 8,3$ ms; (60 Hz), sine | | $V_R = 0$ V | | 50 | A ² s |
| C_J | junction capacitance | $V_R = 400$ V; $f = 1$ MHz | | $T_{VJ} = 25^\circ\text{C}$ | | 4 | pF |



| Package TO-263 (D2Pak-HV) | | | Ratings | | | |
|---------------------------|--|----------------------|---------|------|------|------|
| Symbol | Definition | Conditions | min. | typ. | max. | Unit |
| I_{RMS} | RMS current | per terminal | | | 25 | A |
| T_{VJ} | virtual junction temperature | | -55 | | 175 | °C |
| T_{op} | operation temperature | | -55 | | 150 | °C |
| T_{stg} | storage temperature | | -55 | | 150 | °C |
| Weight | | | | 1.5 | | g |
| F_C | mounting force with clip | | 20 | | 60 | N |
| $d_{Spp/App}$ | creepage distance on surface / striking distance through air | terminal to terminal | 4.2 | | | mm |
| $d_{Spb/Apb}$ | | terminal to backside | 4.7 | | | mm |

Product Marking



Part description

- D = Diode
- M = Standard Rectifier
- A = (up to 1800V)
- 10 = Current Rating [A]
- P = Phase leg
- 1600 = Reverse Voltage [V]
- PZ = TO-263AB (D2Pak) (2HV)

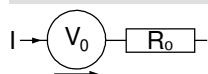
| Ordering | Ordering Number | Marking on Product | Delivery Mode | Quantity | Code No. |
|-------------|------------------|--------------------|---------------|----------|----------|
| Standard | DMA10P1600PZ-TRL | DMA10P1600PZ | Tape & Reel | 800 | 513688 |
| Alternative | DMA10P1600PZ-TUB | DMA10P1600PZ | Tube | 50 | 525340 |

| Similar Part | Package | Voltage class |
|--------------|------------------------|---------------|
| DMA10P1800PZ | TO-263AB (D2Pak) (2HV) | 1800 |
| DAA10P1800PZ | TO-263AB (D2Pak) (2HV) | 1800 |

Equivalent Circuits for Simulation

* on die level

$T_{VJ} = 175\text{°C}$

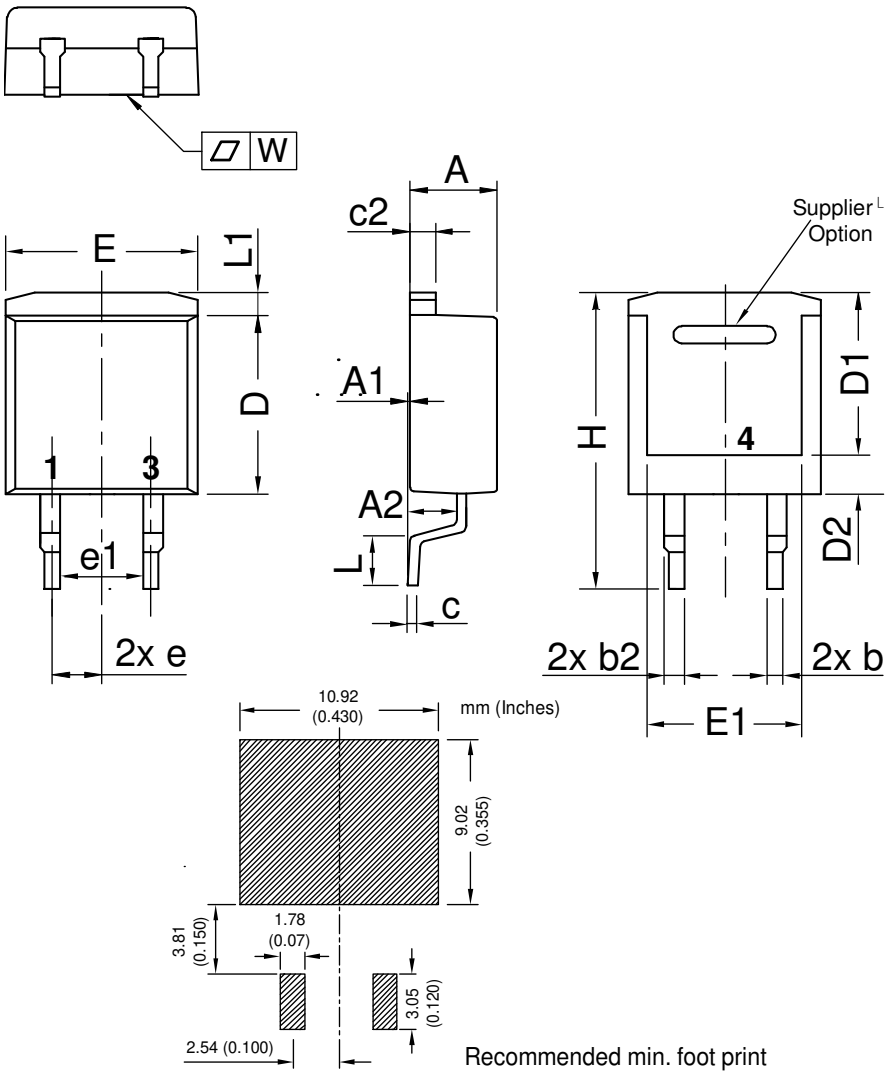


Rectifier

| | | | |
|--------------|--------------------|------|----|
| $V_{0\ max}$ | threshold voltage | 0.82 | V |
| $R_{0\ max}$ | slope resistance * | 34 | mΩ |

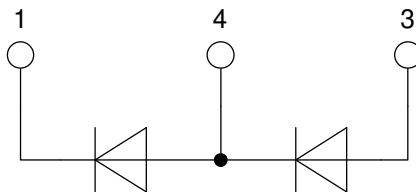


Outlines TO-263 (D2Pak-HV)



| Dim. | Millimeter | | Inches | |
|------|------------|-------|-------------|-------|
| | min | max | min | max |
| A | 4.06 | 4.83 | 0.160 | 0.190 |
| A1 | typ. 0.10 | | typ. 0.004 | |
| A2 | 2.41 | | 0.095 | |
| b | 0.51 | 0.99 | 0.020 | 0.039 |
| b2 | 1.14 | 1.40 | 0.045 | 0.055 |
| c | 0.40 | 0.74 | 0.016 | 0.029 |
| c2 | 1.14 | 1.40 | 0.045 | 0.055 |
| D | 8.38 | 9.40 | 0.330 | 0.370 |
| D1 | 8.00 | 8.89 | 0.315 | 0.350 |
| D2 | 2.3 | | 0.091 | |
| E | 9.65 | 10.41 | 0.380 | 0.410 |
| E1 | 6.22 | 8.50 | 0.245 | 0.335 |
| e | 2,54 BSC | | 0,100 BSC | |
| e1 | 4.28 | | 0.169 | |
| H | 14.61 | 15.88 | 0.575 | 0.625 |
| L | 1.78 | 2.79 | 0.070 | 0.110 |
| L1 | 1.02 | 1.68 | 0.040 | 0.066 |
| W | typ. 0.02 | 0.040 | typ. 0.0008 | 0.002 |

All dimensions conform with and/or within JEDEC standard.



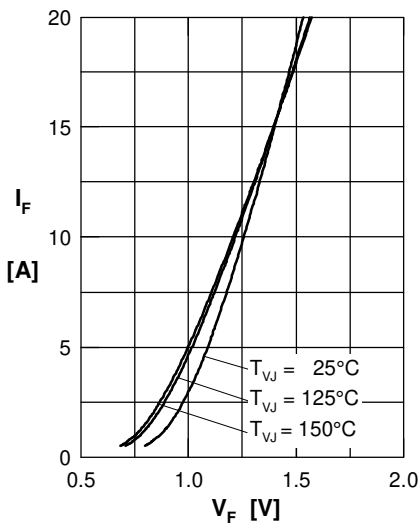
Rectifier


Fig. 1 Forward current versus voltage drop per diode

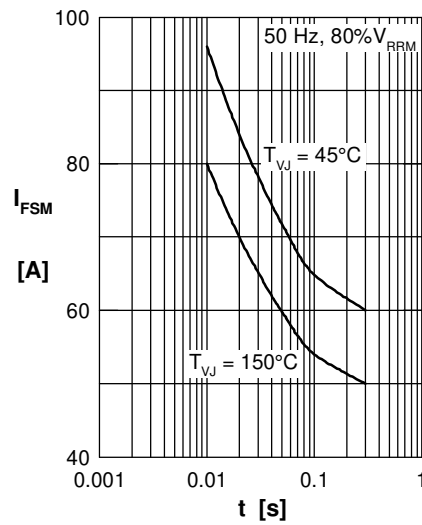


Fig. 2 Surge overload current

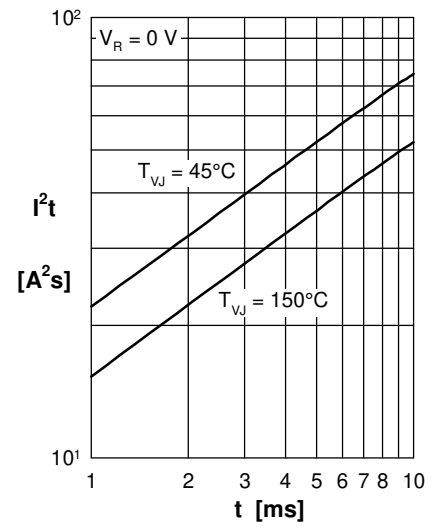
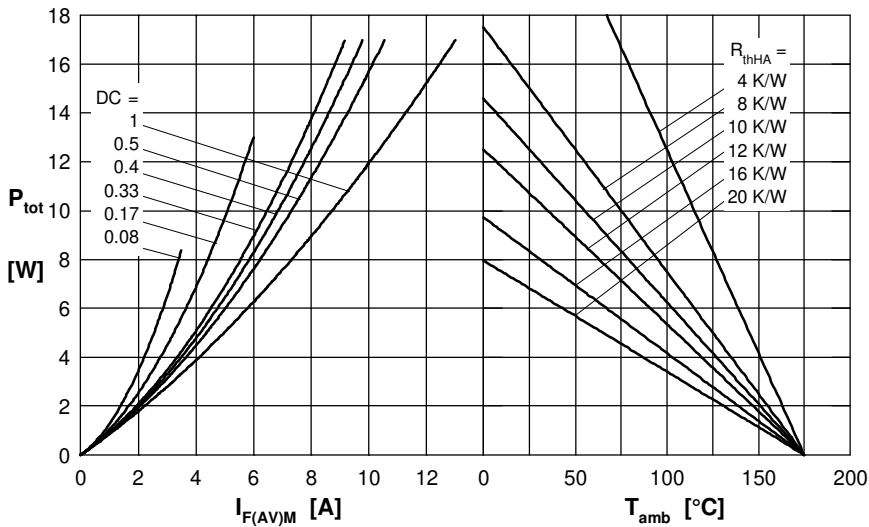

 Fig. 3 I^2t versus time per diode


Fig. 4 Power dissipation vs. direct output current and ambient temperature

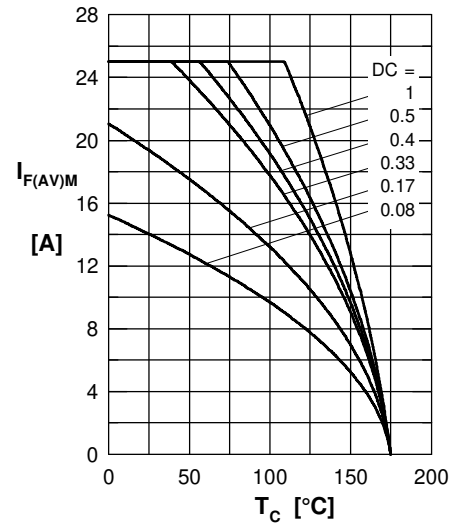


Fig. 5 Max. forward current vs. case temperature

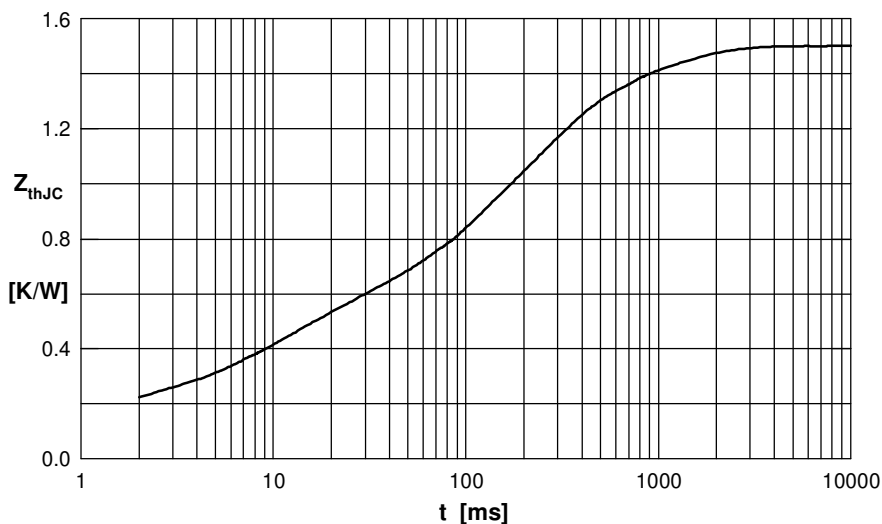


Fig. 6 Transient thermal impedance junction to case

 Constants for Z_{thJC} calculation:

| i | R_{thi} (K/W) | t_i (s) |
|---|-----------------|-----------|
| 1 | 0.155 | 0.0005 |
| 2 | 0.332 | 0.0095 |
| 3 | 0.713 | 0.17 |
| 4 | 0.3 | 0.8 |