

preliminary

Sonic Fast Recovery Diode

V_{RRM}	=	600 V
I_{FAV}	= 2x	20 A
t_{rr}	=	40 ns

High Performance Fast Recovery Diode
 Low Loss and Soft Recovery
 Common Cathode

Part number

DHG40C600HB

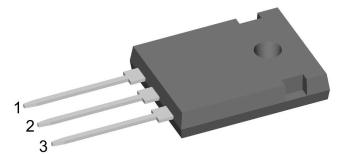

Backside: cathode

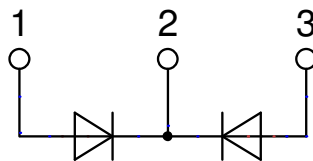

Features / Advantages:

- Planar passivated chips
- Very low leakage current
- Very short recovery time
- Improved thermal behaviour
- Very low I_{rm} -values
- Very soft recovery behaviour
- Avalanche voltage rated for reliable operation
- Soft reverse recovery for low EMI/RFI
- Low I_{rm} reduces:
 - Power dissipation within the diode
 - Turn-on loss in the commutating switch

Applications:

- Antiparallel diode for high frequency switching devices
- Antisaturation diode
- Snubber diode
- Free wheeling diode
- Rectifiers in switch mode power supplies (SMPS)
- Uninterruptible power supplies (UPS)

Package: TO-247

- Industry standard outline
- RoHS compliant
- Epoxy meets UL 94V-0

Terms Conditions of usage:

The data contained in this product data sheet is exclusively intended for technically trained staff. The user will have to evaluate the suitability of the product for the intended application and the completeness of the product data with respect to his application. The specifications of our components may not be considered as an assurance of component characteristics. The information in the valid application- and assembly notes must be considered. Should you require product information in excess of the data given in this product data sheet or which concerns the specific application of your product, please contact your local sales office.

Due to technical requirements our product may contain dangerous substances. For information on the types in question please contact your local sales office.

Should you intend to use the product in aviation, in health or life endangering or life support applications, please notify. For any such application we urgently recommend

- to perform joint risk and quality assessments;

- the conclusion of quality agreements;

- to establish joint measures of an ongoing product survey, and that we may make delivery dependent on the realization of any such measures.

Fast Diode				Ratings			
Symbol	Definition	Conditions		min.	typ.	max.	Unit
V_{RSM}	max. non-repetitive reverse blocking voltage					600	V
V_{RRM}	max. repetitive reverse blocking voltage					600	V
I_R	reverse current, drain current	$V_R = 600\text{ V}$		$T_{VJ} = 25^\circ\text{C}$		25	μA
		$V_R = 600\text{ V}$		$T_{VJ} = 125^\circ\text{C}$		1.5	mA
V_F	forward voltage drop	$I_F = 20\text{ A}$		$T_{VJ} = 25^\circ\text{C}$		2.24	V
		$I_F = 40\text{ A}$				3.15	V
		$I_F = 20\text{ A}$		$T_{VJ} = 125^\circ\text{C}$		2.19	V
		$I_F = 40\text{ A}$				3.21	V
I_{FAV}	average forward current	$T_C = 95^\circ\text{C}$	rectangular	$T_{VJ} = 150^\circ\text{C}$		20	A
V_{FO}	threshold voltage	} for power loss calculation only		$T_{VJ} = 150^\circ\text{C}$		1.12	V
r_F	slope resistance					49	m Ω
R_{thJC}	thermal resistance junction to case					0.9	K/W
R_{thCH}	thermal resistance case to heatsink				0.25		K/W
P_{tot}	total power dissipation			$T_C = 25^\circ\text{C}$		140	W
I_{FSM}	max. forward surge current	$t = 10\text{ ms}; (50\text{ Hz}), \text{ sine}; V_R = 0\text{ V}$		$T_{VJ} = 45^\circ\text{C}$		150	A
C_J	junction capacitance	$V_R = 400\text{ V}$ $f = 1\text{ MHz}$		$T_{VJ} = 25^\circ\text{C}$		12	pF
I_{RM}	max. reverse recovery current	} $I_F = 20\text{ A}; V_R = 300\text{ V}$		$T_{VJ} = 25^\circ\text{C}$		8	A
				$T_{VJ} = 125^\circ\text{C}$		12	A
t_{rr}	reverse recovery time	} $-di_F/dt = 450\text{ A}/\mu\text{s}$		$T_{VJ} = 25^\circ\text{C}$		40	ns
				$T_{VJ} = 125^\circ\text{C}$		60	ns

preliminary

Package TO-247			Ratings			
Symbol	Definition	Conditions	min.	typ.	max.	Unit
I_{RMS}	RMS current	per terminal ¹⁾			70	A
T_{VJ}	virtual junction temperature		-55		150	°C
T_{op}	operation temperature		-55		125	°C
T_{stg}	storage temperature		-55		150	°C
Weight				6		g
M_D	mounting torque		0.8		1.2	Nm
F_C	mounting force with clip		20		120	N

Product Marking

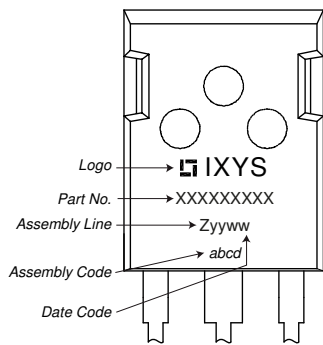

Part description

- D = Diode
- H = Sonic Fast Recovery Diode
- G = extreme fast
- 40 = Current Rating [A]
- C = Common Cathode
- 600 = Reverse Voltage [V]
- HB = TO-247AD (3)

Ordering	Ordering Number	Marking on Product	Delivery Mode	Quantity	Code No.
Standard	DHG40C600HB	DHG40C600HB	Tube	30	505145

Similar Part	Package	Voltage class
DHG40C600PB	TO-220AB (3)	600

Equivalent Circuits for Simulation

* on die level

$T_{VJ} = 150\text{ °C}$

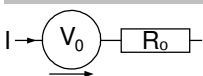

Fast Diode

$V_{0\ max}$	threshold voltage	1.12	V
$R_{0\ max}$	slope resistance *	46	mΩ

Outlines TO-247

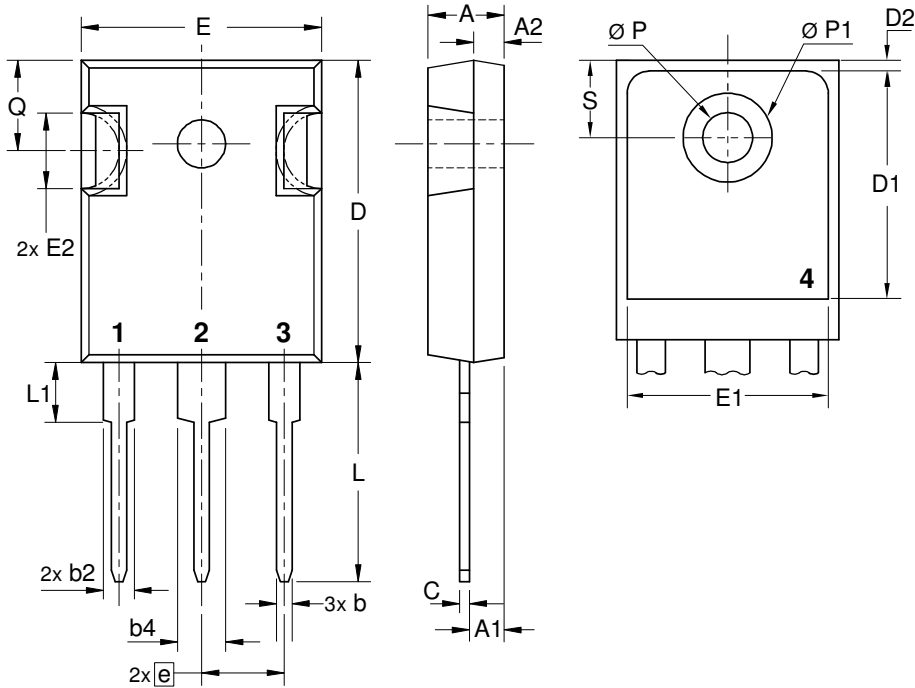

Sym.	Inches		Millimeter	
	min.	max.	min.	max.
A	0.185	0.209	4.70	5.30
A1	0.087	0.102	2.21	2.59
A2	0.059	0.098	1.50	2.49
D	0.819	0.845	20.79	21.45
E	0.610	0.640	15.48	16.24
E2	0.170	0.216	4.31	5.48
e	0.215 BSC		5.46 BSC	
L	0.780	0.800	19.80	20.30
L1	-	0.177	-	4.49
Ø P	0.140	0.144	3.55	3.65
Q	0.212		5.38	
S	0.242 BSC		6.14 BSC	
b	0.039	0.055	0.99	1.40
b2	0.065	0.094	1.65	2.39
b4	0.102	0.135	2.59	3.43
c	0.015	0.035	0.38	0.89
D1	0.515	-	13.07	-
D2	0.020	0.053	0.51	1.35
E1	0.530	-	13.45	-
Ø P1	-	0.29	-	7.39

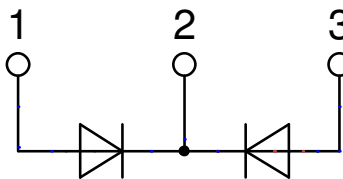

Fast Diode

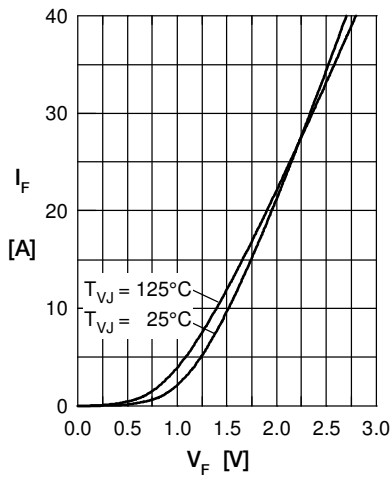

Fig. 1 Typ. Forward current versus V_F

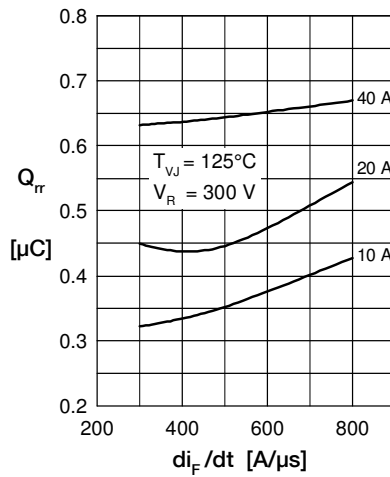

Fig. 2 Typ. reverse recov. charge Q_{rr} versus di/dt

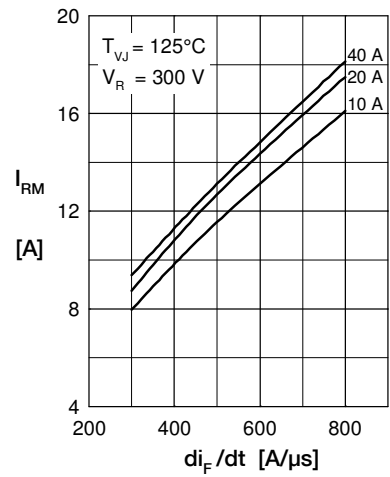

Fig. 3 Typ. peak reverse current I_{RM} versus di/dt

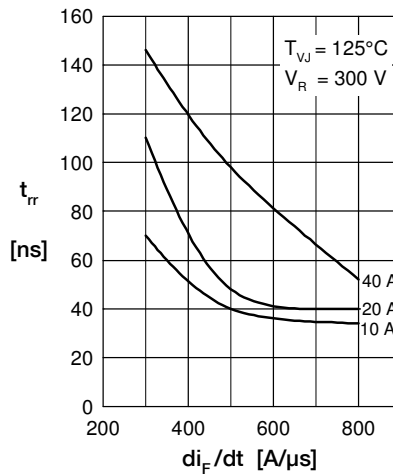

Fig. 4 Dynamic parameters Q_{rr} , I_{RM} versus T_{VJ}

Fig. 5 Typ. recovery time t_{rr} versus di/dt

Fig. 6 Typ. recovery energy E_{rec} versus di/dt

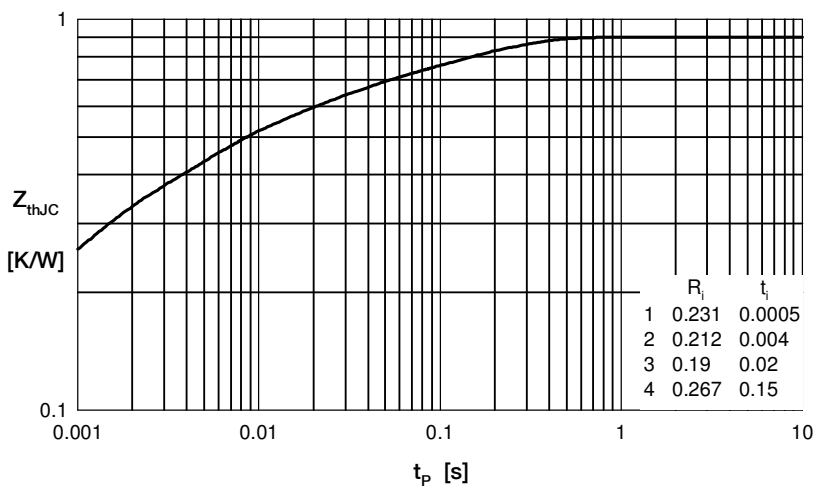

Fig. 7 Typ. transient thermal impedance junction to case