

Emitter Controlled Diode Rapid 1 Advanced Isolation

Rapid switching emitter controlled diode in fully isolated package

Features:

- 650V Emitter Controlled technology
- Temperature stable behavior of key parameters
- Low forward voltage (V_F)
- Low reverse recovery charge (Q_{rr})
- Low reverse recovery current (I_{rrm})
- Softness factor >1
- Maximum junction temperature 175°C
- $2500 V_{RMS}$ electrical isolation, 50/60 Hz, $t=1$ min
- 100 % tested isolated mounting surface
- Pb-free lead plating; RoHS compliant

Potential Applications:

- Air Conditioning PFC
- General Purpose Drives (GPD)

Package pin definition:

- Pin 1 - not connected
- Pin 2 - cathode
- Pin 3 - anode

Product Validation:

Qualified for industrial applications according to the relevant tests of JEDEC 47/20/22

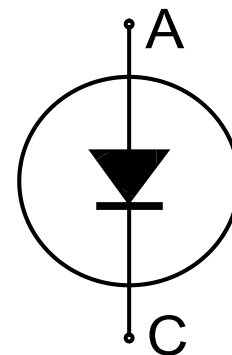

Fully isolated package TO-247



Key Performance and Package Parameters

Type	V_{rrm}	I_f	$V_f, T_{vj}=25^\circ\text{C}$	T_{vjmax}	Marking	Package
IDFW40E65D1E	650V	40A	1.7V	175°C	D40E65D1E	PG-TO247-3-AI

Emitter Controlled Diode Rapid 1 Advanced Isolation

Table of Contents

Description	1
Table of Contents	2
Maximum Ratings	3
Thermal Resistance	3
Electrical Characteristics	3
Electrical Characteristics Diagrams	5
Package Drawing	8
Testing Conditions	9
Revision History	10
Disclaimer	11

Emitter Controlled Diode Rapid 1 Advanced Isolation

Maximum Ratings

For optimum lifetime and reliability, Infineon recommends operating conditions that do not exceed 80% of the maximum ratings stated in this datasheet.

Parameter	Symbol	Value	Unit
Repetitive peak reverse voltage, $T_{vj} \geq 25^{\circ}\text{C}$	V_{RRM}	650	V
Diode forward current, limited by T_{vjmax} $T_h = 25^{\circ}\text{C}$ $T_h = 65^{\circ}\text{C}$	I_F	42.0 35.0	A
Diode pulsed current, t_p limited by T_{vjmax}	I_{Fpuls}	120.0	A
Power dissipation $T_h = 25^{\circ}\text{C}$ Power dissipation $T_h = 65^{\circ}\text{C}$	P_{tot}	78.0 57.0	W
Operating junction temperature	T_{vj}	-40...+175	$^{\circ}\text{C}$
Storage temperature	T_{stg}	-55...+150	$^{\circ}\text{C}$
Soldering temperature, wave soldering 1.6mm (0.063in.) from case for 10s		260	$^{\circ}\text{C}$
Mounting torque, M3 screw, PG-TO247-3-AI Maximum of mounting processes: 3	M	0.6	Nm
Isolation voltage RMS, $f = 50/60\text{Hz}$, $t = 1\text{min}^{(1)}$	V_{isol}	2500	V

Thermal Resistance

Parameter	Symbol	Conditions	Value			Unit
			min.	typ.	max.	
R_{th} Characteristics						
Diode thermal resistance, ²⁾ junction - heatsink	$R_{th(j-h)}$		-	1.75	1.92	K/W
Thermal resistance junction - ambient	$R_{th(j-a)}$		-	-	65	K/W

Electrical Characteristic, at $T_{vj} = 25^{\circ}\text{C}$, unless otherwise specified

Parameter	Symbol	Conditions	Value			Unit
			min.	typ.	max.	
Static Characteristic						
Diode forward voltage	V_F	$I_F = 40.0\text{A}$ $T_{vj} = 25^{\circ}\text{C}$ $T_{vj} = 175^{\circ}\text{C}$	- -	1.70 1.75	2.10 -	V
Reverse leakage current	I_R	$V_R = 650\text{V}$ $T_{vj} = 25^{\circ}\text{C}$ $T_{vj} = 175^{\circ}\text{C}$	- -	- 350	40 -	μA

Electrical Characteristic, at $T_{vj} = 25^{\circ}\text{C}$, unless otherwise specified

Parameter	Symbol	Conditions	Value			Unit
			min.	typ.	max.	
Dynamic Characteristic						
Internal emitter inductance measured 5mm (0.197 in.) from case	L_E		-	13.0	-	nH

¹⁾ For a proper handling and assembly of the advanced isolation device in the application refer to the note at the package drawing.

²⁾ At force on body $F = 500\text{N}$, $T_a = 25^{\circ}\text{C}$

 Emitter Controlled Diode Rapid 1 Advanced Isolation

Switching Characteristic, Inductive Load

Parameter	Symbol	Conditions	Value			Unit
			min.	typ.	max.	

Diode Characteristic, at $T_{vj} = 25^{\circ}\text{C}$

Diode reverse recovery time	t_{rr}	$T_{vj} = 25^{\circ}\text{C}$, $V_R = 400\text{V}$, $I_F = 40.0\text{A}$, $di_F/dt = 1000\text{A}/\mu\text{s}$, $L\sigma = 75\text{nH}$, $C\sigma = 30\text{pF}$, Switch IKFW50N60DH3	-	76	-	ns
Diode reverse recovery charge	Q_{rr}		-	0.57	-	μC
Diode peak reverse recovery current	I_{rrm}		-	11.0	-	A
Diode peak rate of fall of reverse recovery current during t_b	di_{rr}/dt		-	-885	-	$\text{A}/\mu\text{s}$
Diode reverse recovery time	t_{rr}	$T_{vj} = 25^{\circ}\text{C}$, $V_R = 400\text{V}$, $I_F = 40.0\text{A}$, $di_F/dt = 300\text{A}/\mu\text{s}$, $L\sigma = 75\text{nH}$, $C\sigma = 30\text{pF}$, Switch IKFW50N60DH3	-	232	-	ns
Diode reverse recovery charge	Q_{rr}		-	0.52	-	μC
Diode peak reverse recovery current	I_{rrm}		-	6.0	-	A
Diode peak rate of fall of reverse recovery current during t_b	di_{rr}/dt		-	-130	-	$\text{A}/\mu\text{s}$

Switching Characteristic, Inductive Load

Parameter	Symbol	Conditions	Value			Unit
			min.	typ.	max.	

Diode Characteristic, at $T_{vj} = 175^{\circ}\text{C}$

Diode reverse recovery time	t_{rr}	$T_{vj} = 175^{\circ}\text{C}$, $V_R = 400\text{V}$, $I_F = 40.0\text{A}$, $di_F/dt = 1000\text{A}/\mu\text{s}$, $L\sigma = 75\text{nH}$, $C\sigma = 30\text{pF}$, Switch IKFW50N60DH3	-	106	-	ns
Diode reverse recovery charge	Q_{rr}		-	1.51	-	μC
Diode peak reverse recovery current	I_{rrm}		-	20.0	-	A
Diode peak rate of fall of reverse recovery current during t_b	di_{rr}/dt		-	-760	-	$\text{A}/\mu\text{s}$
Diode reverse recovery time	t_{rr}	$T_{vj} = 175^{\circ}\text{C}$, $V_R = 400\text{V}$, $I_F = 40.0\text{A}$, $di_F/dt = 300\text{A}/\mu\text{s}$, $L\sigma = 75\text{nH}$, $C\sigma = 30\text{pF}$, Switch IKFW50N60DH3	-	228	-	ns
Diode reverse recovery charge	Q_{rr}		-	1.33	-	μC
Diode peak reverse recovery current	I_{rrm}		-	9.8	-	A
Diode peak rate of fall of reverse recovery current during t_b	di_{rr}/dt		-	-160	-	$\text{A}/\mu\text{s}$

Emitter Controlled Diode Rapid 1 Advanced Isolation

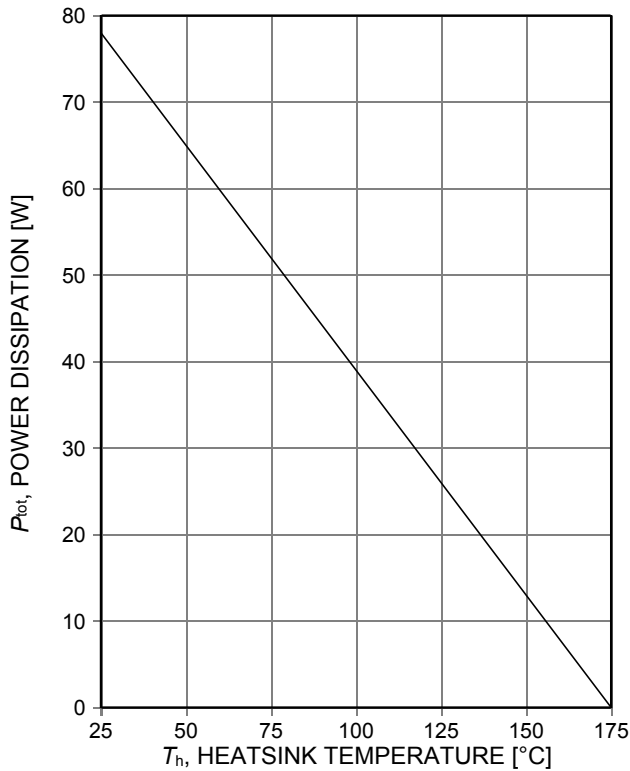

Figure 1. Power dissipation as a function of heatsink temperature ($T_j \leq 175^\circ\text{C}$)

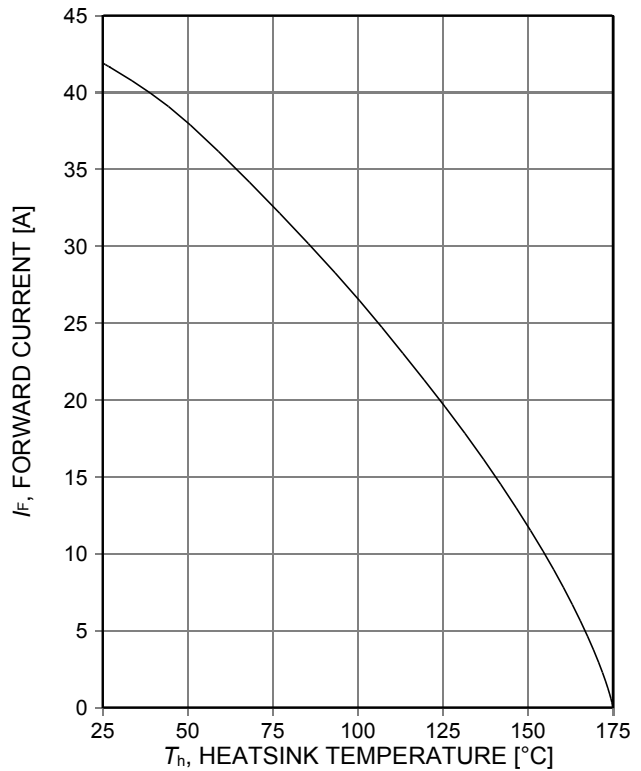

Figure 2. Diode forward current as a function of heatsink temperature

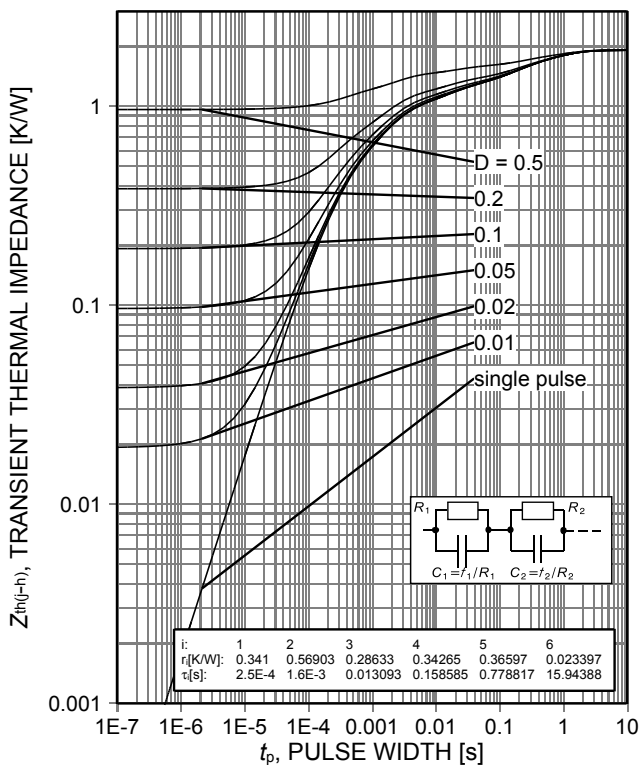

Figure 3. Diode transient thermal impedance as a function of pulse width ($D = t_p/T$)

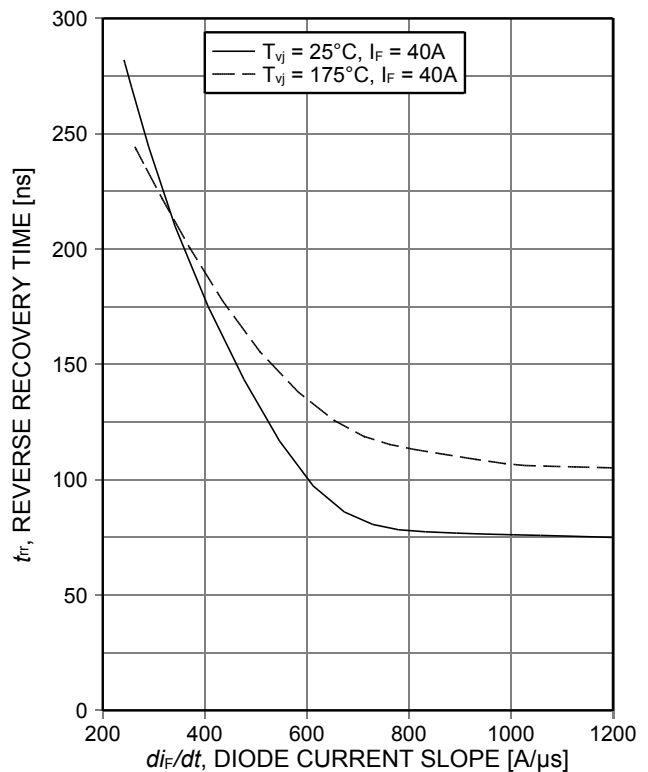

Figure 4. Typical reverse recovery time as a function of diode current slope ($V_R = 400\text{V}$)

Emitter Controlled Diode Rapid 1 Advanced Isolation

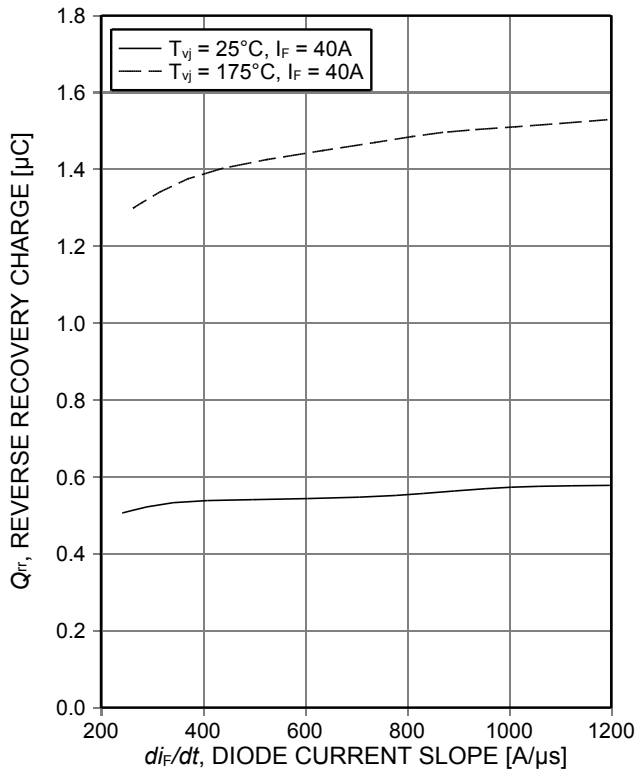

Figure 5. Typical reverse recovery charge as a function of diode current slope (VR=400V)

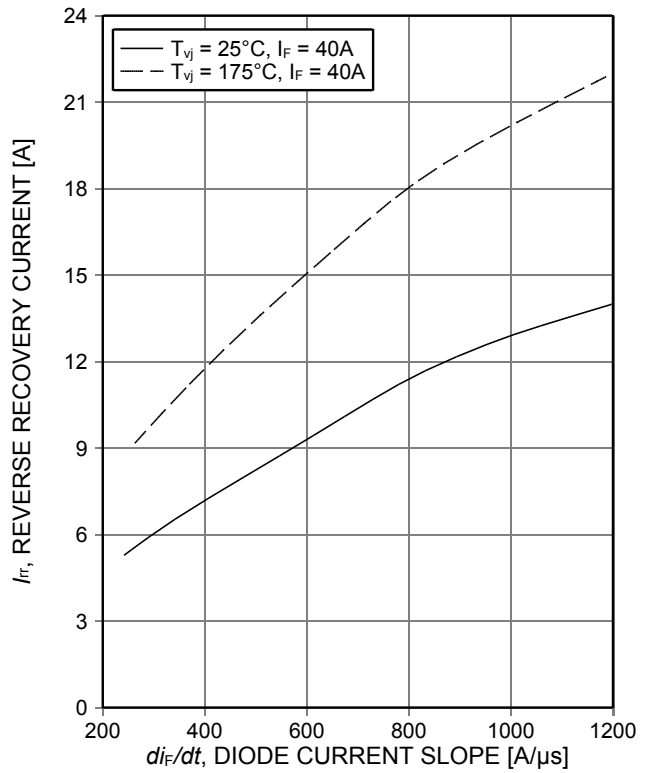

Figure 6. Typical reverse recovery current as a function of diode current slope (VR=400V)

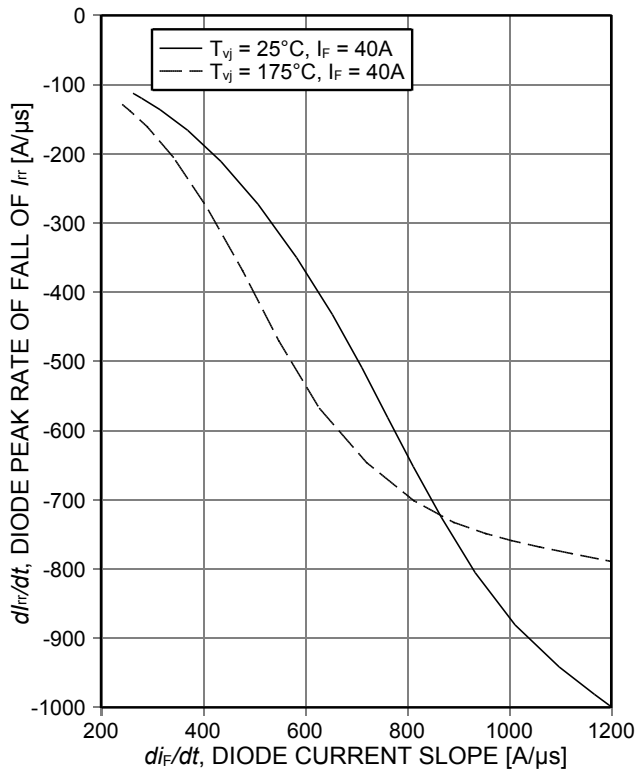

Figure 7. Typical peak reverse recovery current as a function of diode current slope (VR=400V)

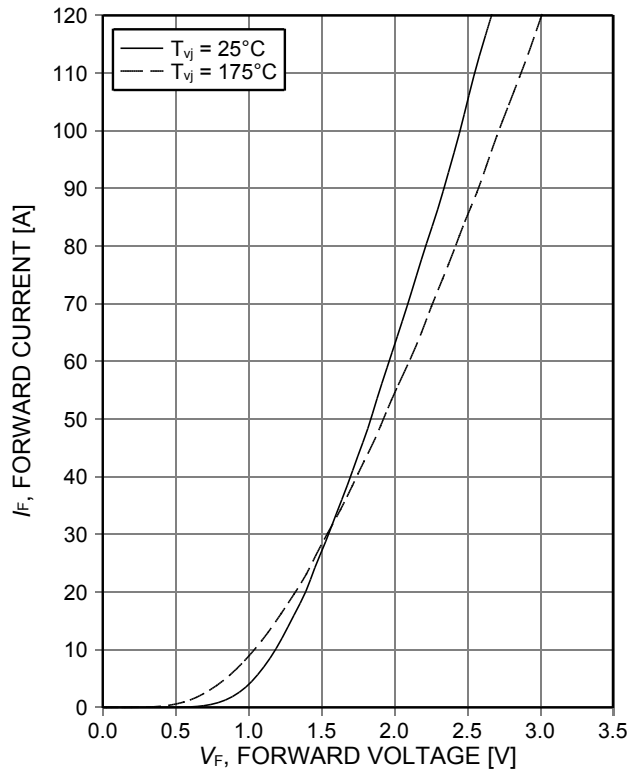

Figure 8. Typical diode forward current as a function of forward voltage

Emitter Controlled Diode Rapid 1 Advanced Isolation

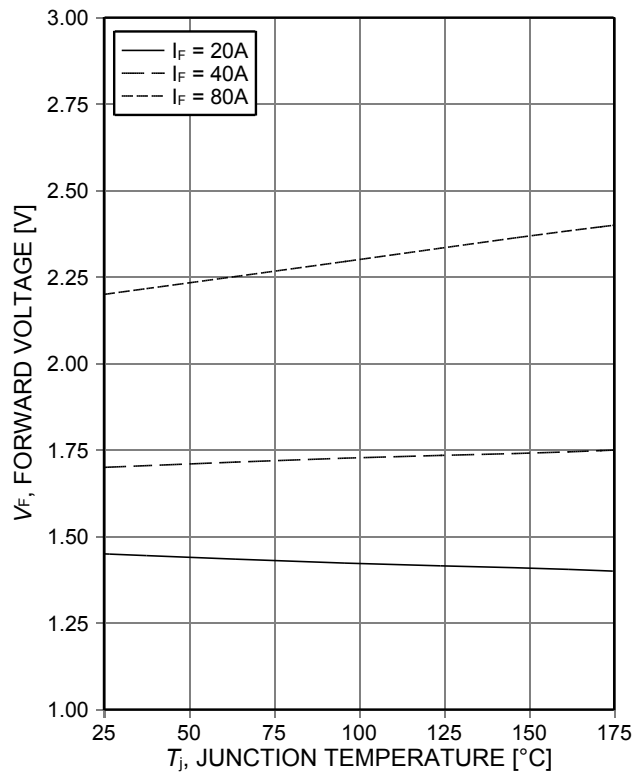
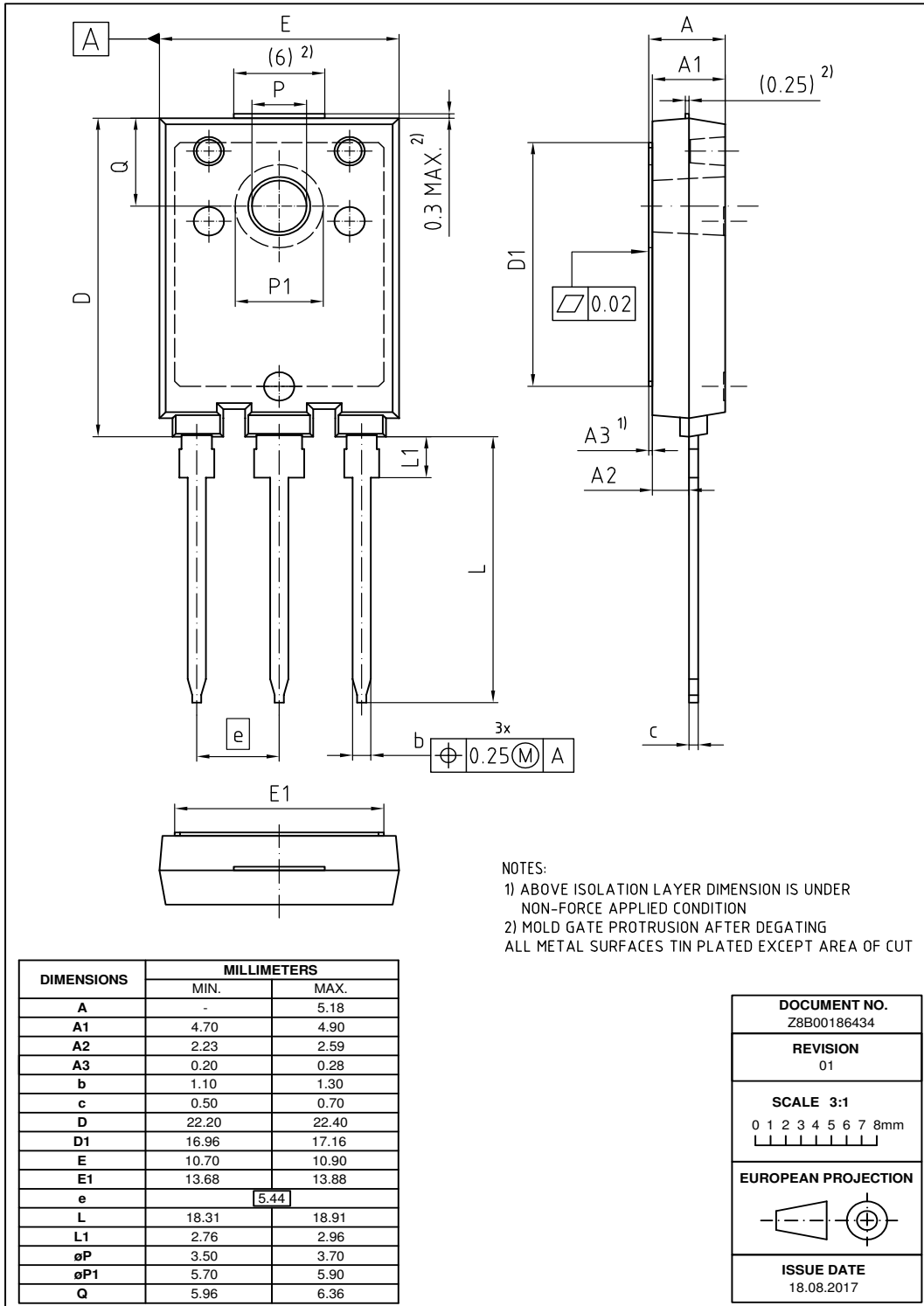

Figure 9. Typical diode forward voltage as a function of junction temperature

PG-TO247-3-AI (PG-HSIP247-3)



Note: For a proper handling and assembly of the advanced isolation device in the application the isolation layer must not be exposed to potential penetration via sharp implements or mechanical impacts/shocks, which exceed levels indicated in International Standard (IEC60068-2-6 and IEC60068-2-27). The advanced isolation device is intended only to be used assembled on an appropriate heatsink with recommended flatness of <20µm per 100mm and roughness of <10µm.

Emitter Controlled Diode Rapid 1 Advanced Isolation

Testing Conditions

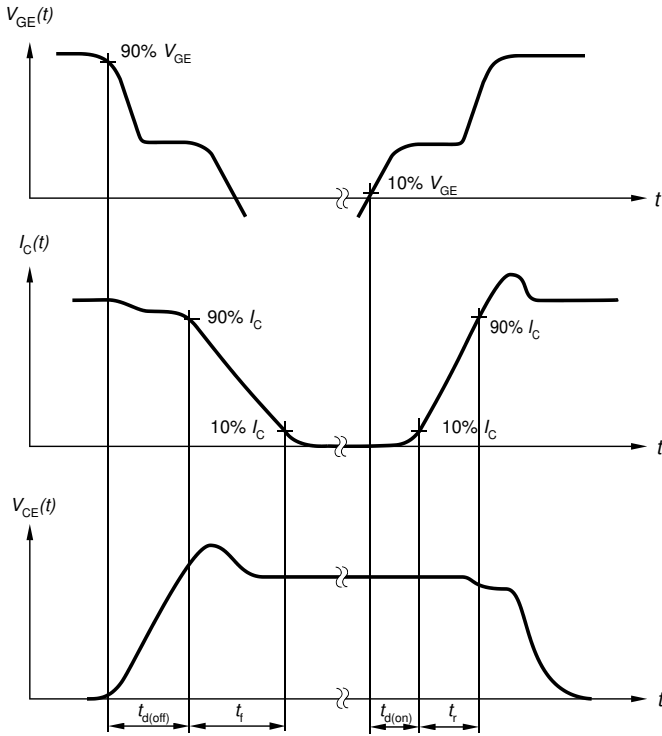

Figure A. Definition of switching times

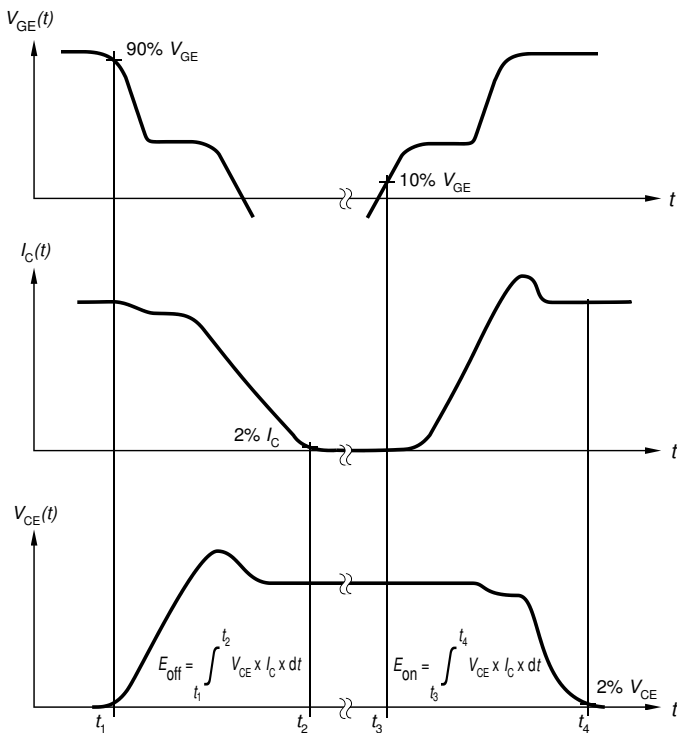

Figure B. Definition of switching losses

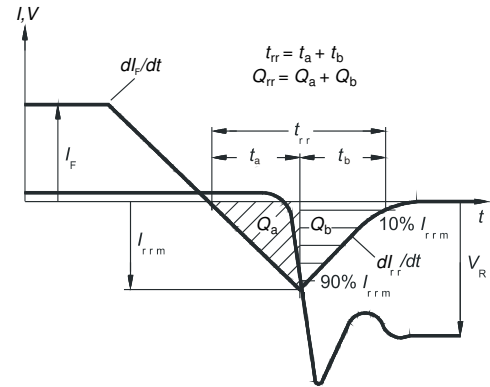

Figure C. Definition of diode switching characteristics

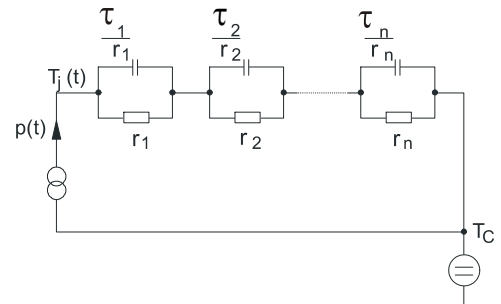

Figure D. Thermal equivalent circuit

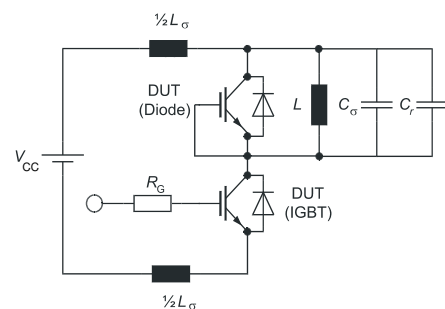

Figure E. Dynamic test circuit
Parasitic inductance L_{σ} ,
parasitic capacitor C_{σ} ,
relief capacitor C_r ,
(only for ZVT switching)

Emitter Controlled Diode Rapid 1 Advanced Isolation

Revision History

IDFW40E65D1E

Revision: 2017-10-27, Rev. 2.2

Previous Revision

Revision	Date	Subjects (major changes since last revision)
2.1	2017-09-21	Final data sheet
2.2	2017-10-27	Update condition Fig.2

Trademarks

All referenced product or service names and trademarks are the property of their respective owners.

Published by
Infineon Technologies AG
81726 München, Germany
© Infineon Technologies AG 2017.
All Rights Reserved.

Important Notice

The information given in this document shall in no event be regarded as a guarantee of conditions or characteristics ("Beschaffenheitsgarantie"). With respect to any examples, hints or any typical values stated herein and/or any information regarding the application of the product, Infineon Technologies hereby disclaims any and all warranties and liabilities of any kind, including without limitation warranties of non-infringement of intellectual property rights of any third party.

In addition, any information given in this document is subject to customer's compliance with its obligations stated in this document and any applicable legal requirements, norms and standards concerning customer's products and any use of the product of Infineon Technologies in customer's applications.

The data contained in this document is exclusively intended for technically trained staff. It is the responsibility of customer's technical departments to evaluate the suitability of the product for the intended application and the completeness of the product information given in this document with respect to such application.

For further information on the product, technology, delivery terms and conditions and prices please contact your nearest Infineon Technologies office (www.infineon.com).

Please note that this product is not qualified according to the AEC Q100 or AEC Q101 documents of the Automotive Electronics Council.

Warnings

Due to technical requirements products may contain dangerous substances. For information on the types in question please contact your nearest Infineon Technologies office.

Except as otherwise explicitly approved by Infineon Technologies in a written document signed by authorized representatives of Infineon Technologies, Infineon Technologies' products may not be used in any applications where a failure of the product or any consequences of the use thereof can reasonably be expected to result in personal injury.